



**U.S. Industrial Fasteners of AZ, Inc.**

## **2023 Catalog**

Supplying hardware and fasteners  
to the southwest since 1981.



**Celebrating over 40 years of business!**

Email us at:  
**[sales@usifaz.com](mailto:sales@usifaz.com)**

Visit our website  
**[www.usifaz.com](http://www.usifaz.com)**

Toll Free: (800) 289-5386 Phone: (480) 967-8702 Fax: (480) 967-1907

## *40 Years of U.S. Industrial Fasteners*

U.S. Industrial Fasteners began in a small corner of a warehouse over 40 years ago, a partnership between two great men: Keith Blackburn and Sam Vancel. They shared a vision to supply industrial fasteners to customers throughout Arizona.

In 1981, Sam and Keith established the company with hard work, integrity, and a common vision, but none of what we are today would have been possible without the support of our customers, our employees and, of course, our families. Keith and Sam grew a company that prioritized customer service and personal relationships. More than that, they hired great employees, a stellar team of people who have been and continue to be integral to U.S. Industrial's success. Many have grown with us, and others are bringing new ideas and energy every day. And of course, Keith and Sam both valued their families and friendships above all.

Keith and Sam were colleagues in business who became successful partners and then found a friendship that grew throughout the years. Keith was the accountant with a head for finance and provided a structural foundation for the company. Sam was the salesman with a dynamic personality that opened doors and built relationships outside and inside the company. Both were intelligent businessmen who grew up in the mobile home industry and had great ideas about how a company should be run. Keith made everything happen inside and stabilized internal operations, and Sam was the creative drive for growth and the face of the company. Together they grew a company that expanded beyond fasteners into hardware for the furniture and cabinet industries and became a force in the industry. Always they both worked hard to give customers great service and competitive pricing.

After many summers working and learning under these two great mentors, I graduated college in 1992. My father and Sam invited me to join US Industrial full-time. We continued to grow and expanded the product line into abrasives, adhesives, hardware and other products to fit our growing customer base. As always, Sam was the voice for change and growth and Keith was the voice for caution and stability. I learned from both. In December of 2001, we lost Sam too soon as he passed away from lung cancer. Sam's loss was painful, and the absence of his voice was profound. But Keith and I found a way forward and a new and different partnership grew between my father and me. We continued to run and grow the company together. Twenty years later, after many more successes, Keith too passed away. Lewy Body Dementia took his voice and then his life. The far-reaching imprint that Sam and Keith left on U.S. Industrial is readily apparent today in our great customer relationships, our loyal employees and, I hope, in me.

I am sincerely grateful to everyone who has shared in the journey so far. In so many ways, U.S. Industrial Fasteners is a family and I'm proud to say that it is growing again as a 3rd generation of Blackburns enters the business this year. After his many summers working and learning at U.S. Industrial, I invited my son, Tyler, to join the company full-time.

We are looking forward to many more years of success and service to our customers.



Kevin Blackburn  
U.S. Industrial Fasteners

Phone: 480-967-8702  
800-289-5386

**U.S. Industrial Fasteners of AZ, Inc.**



2026 E. Cedar St Tempe, AZ 85281  
Fax: 480-967-1907

# U.S. Industrial Fasteners - Vendor List

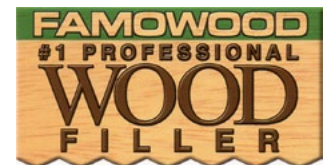

# Terms And Conditions

## Terms

1% 10 Net 30 Days. Subject to credit approval

## Minimum Order

All orders under \$50.00 will be subject to a \$10.00 below minimum fee.

## Freight

Products ordered in the Phoenix Metro area are delivered, free of charge, if meeting the current minimum order. Product shipped from the Phoenix warehouse within the state of Arizona will be prepaid if the order exceeds \$300.00. Product shipped to adjoining states must exceed \$750.00 to be prepaid. All residential shipments are subject to an additional handling charge.

## Return Goods

Returns are subject to a restocking fee. Returns must be in original cartons and packaging (not used). Returns must be within 30 calendar days of purchase. Defective product must be inspected before credit is issued. Credits for returns are put on account for use towards future purchases (no cash or check refunds).

## Special Order Items

Special order items are not returnable or cancelable once order is placed (exceptions to this requires prior approval).

## Shortages

Any shortages on your shipment must be reported within 10 days of the shipping date for the proper verification and possible adjustment.

## Prices

ALL PRICES, TERMS AND SPECIFICATIONS ARE SUBJECT TO CHANGE WITHOUT PRIOR NOTICE.

## Warranty

U.S. Industrial Fasteners, Inc. hereby expressly warrants the products sold to be free of defects in workmanship and materials for a period of thirty (30) days from the date of purchase. This express warranty is the only warranty applicable to the products sold. All warranties of merchantability and fitness for a particular purpose are expressly excluded. U.S. Industrial Fasteners, Inc.'s liability for any breach of warranty is limited to the replacement of the defective product. Liability for all incidental and consequential damages is hereby disclaimed. Use of the product shall be deemed an acceptance of the warranty with all of its limitations. If the purchaser is not willing to accept this warranty, the purchaser should return the product for a refund.

## Disclaimer

Product photographs and representations shown in this catalog are rendered as accurately as printing processes permit. While every attempt has been made to accurately portray each product, U.S. Industrial Fasteners, Inc. disclaims any liability for variations in photographic accuracy or written description compared with actual product. U.S. Industrial Fasteners reserves the right to correct clerical and typographical errors.

# Table of Contents

---

Hinges	1-17, 20-23
Shutter Hardware	17-22
Lifts & Bed Mechanisms	24-26
Slides	27-44
Ergonomics	45
Swivels	46
Convenience Hardware	47-89
Wood Adornments	89-93
Barn Door Hardware	94-96
Closet Hardware	97-101
Shelf Standard & Brackets	101-103
Brackets & Extrusions	103-107
Cover Caps	107, 151
Edgebanding	107-109
Braces & Bumpers	109-110
Wood Dowels & Plugs	111
Casters & Levelers	111-113
Levelers & Glides	113-114
Connecting Fittings	115-118
Catches	118-120
Shelf Supports	121-123
Grommets	123-124



# Table of Contents

---

Locks	124-128
File Rods & Fittings	129
Lighting	77-83, 130
Decorative Hardware	131-150
Fastcap	151-163
Tools	152-163, 176-177, 201-203
Dust Masks	164
Ear Plugs	164
Miscellaneous Supplies	164-166
Adhesives	167-172
Wood Filler	172-174
Tape	174-175
Abrasives	176-182
Laminate Files	183
Wheels & Discs	183-185
Bits & Blades	185-199
Staples & Brads	200-201
Fasteners	204-219
Anchors	208-210

# Cabinet Quick Reference



Drawer Slides Pages 27-44



European Hinges Pages 1-12



Face Frame Compact Hinges Pages 13-15



Trash Units Page 47-49, 84



Shelf Supports Page 121-122



Bumpers Pages 110



Installation Screws Pages 204-206



Staplers and Brad Nailers Pages 201-203



Staples and Brads Pages 200-201



Gloves Page 165



Caulking Page 171-172



Wood Filler Pages 172-173



Putty Pencils Pages 174



Cedar Shims Page 166



Swing	Attach	94 Degree Thick Door	105 Degree	110 Degree	120 Degree	Cup Width	Cup Depth	Box Quantity
-------	--------	----------------------	------------	------------	------------	-----------	-----------	--------------

**Full Overlay-3/4 Side Panel**

Free Swing	Screw In	65C2PAA99			65C2P8A99	35mm	11mm	300
Free Swing	Dowel			65C2R4A99	65C2R8A99	35mm	11mm	300
Self Closing	Screw In	65C2PBA99		65C2P6A99	65C2P9A99	35mm	11mm	300
Self Closing	Dowel	65C2RBA99		65C2R6A99	65C2R9A99	35mm	11mm	300
Self Closing	Rapido			65C276A99	65C279A99	35mm	11mm	300
Self Closing	Logica			65C2J6A99		35mm	11mm	300



Soft Closing	Screw In		65C1P6AE9			35mm	13mm	300
Soft Closing	Dowel		65C1R6AE9			35mm	13mm	300
Soft Closing	Dowel	65C2RBAE9				35mm	15.5mm	300
Soft Closing	Rapido		65C176AE9			35mm	13mm	300
Soft Closing	Logica		65C1J6AE9			35mm	14mm	300

**Full Overlay-5/8 Side Panel**

Self Closing	Screw In					35mm	11mm	300
Self Closing	Dowel			65C2R6D99	65C2R9D99	35mm	11mm	300



Soft Closing	Dowel		65C1R6DE9			35mm	13mm	300
Soft Closing	Dowel			65C7R6DD9		35mm	14mm	100
Soft Closing	Rapido		65C176DE9			35mm	13mm	300

**Half Overlay**

Free Swing	Dowel			65C2R4G99	65C2R8G99	35mm	11mm	300
Self Closing	Screw In	65C2PBG99		65C2P6G99	65C2P9G99	35mm	11mm	300
Self Closing	Dowel	65C2RBG99		65C2R6G99	65C2R9G99	35mm	11mm	300
Self Closing	Rapido				65C279G99	35mm	11mm	300
Self Closing	Logica			65C2J6G99		35mm	11mm	300



Soft Closing	Screw In		65C1P6GE9			35mm	13mm	300
Soft Closing	Dowel	65C2RBE9	65C1R6GE9	65C7R6GD9		35mm	13mm	300
Soft Closing	Logica			65C7J6GE9		35mm	14mm	300

**Inset**

Free Swing	Screw In	65C2PAP99		65C2R4P99		35mm	11mm	300
Free Swing	Dowel	65C2RAP99				35mm	11mm	300
Self Closing	Screw In	65C2PBP99				35mm	11mm	300
Self Closing	Dowel	65C2RBP99				35mm	11mm	300
Self Closing	Rapido					35mm	11mm	300
Self Closing	Logica			65C2J6P99		35mm	11mm	300



Soft Closing	Dowel		65C1R6PE9			35mm	13mm	300
Soft Closing	Dowel	65C2RBE9				35mm	15.5mm	300



European Hinges - Salice  
Thick Door Hinges



Full Overlay



Half Overlay



Inset



155 Degree Full Overlay

Swing	Attach	Degree	Cup Width	Cup Depth	For Door Thickness Up To	Full Overlay	Half Overlay	Inset	Box Quantity
Free	Screw In	94	40mm	13mm	1 1/2"	65CFA5A99	65CFA5G99	65CFA5P99	300
Self Closing	Screw In	94	40mm	13mm	1 1/2"	65CFA7A99	65CFA7G99	65CFA7P99	300

155 Degree "0" Protrusion / Thick Door (1 1/4)



Swing	Attach	Cup Width	Cup Depth	Full Overlay	Full Overlay 5/8	Box Quantity
Self Closing	Dowel	35mm	8mm	65C2RKA99		100
Soft Closing	Dowel	35mm	8mm	65C2RKA99	65C2RKDD9	100

165 Degree, 35mm Cup, 11mm Depth



Full Overlay



Half Overlay



Inset

Swing	Attach	Full Overlay	Half Overlay	Inset	Box Quantity
Free Swing	Screw In			65C2PEP99	100
Free Swing	Dowel				100
Self Closing	Screw In	65C2PFA99	65C2PFG99	65C2PFP99	100
Self Closing	Dowel	65C2RFA99	65C2RFG99	65C2RFP99	100
Self Closing	Rapido	65C27FA99			100
Self Closing	Logica	65C2JFA99	65C2JFG99		100

Specialty Hinges



Corner Hinge



Pie Corner Hinge



Negative Angle Hinge



Blind Corner Hinge



Specialty Profiles Hinge

Type	Swing	Attach	35mm Cup 11mm Depth	Cup Width	Cup Depth	Box Quantity
45 Degree Corner	Self Closing	Dowel	65C2RBM99*	35mm	11mm	150
45 Degree Corner	Self Closing	Dowel	65C2RBM99AC*	35mm	11mm	150
Pie Corner	Self Closing	Dowel	65C2RYA99	35mm	11mm	150
-30 Degree Negative Angle	Self Closing	Dowel	65C2R7W99*	35mm	11mm	150
-45 Degree Negative Angle	Self Closing	Dowel	65C2RBH99*	35mm	11mm	150
Blind Corner Overlay	Self Closing	Dowel	65C2R6N99AM	35mm	11mm	150
Blind Corner	Self Closing	Dowel	65C2RBN99AC*	35mm	11mm	150
45 Degree Corner	Self Closing	Logica	65C2J7M99AC*	35mm	11mm	150
-45 Degree Negative Angle	Self Closing	Logica	65C2J7H99*	35mm	11mm	150
Blind Corner	Self Closing	Logica	65C2JBN99AC*	35mm	11mm	150
110 Degree Special Profiles	Self Closing	Screw In	65CBP2A99	35mm	9mm	150

\* Thick Door Hinges



Corner Hinge



Blind Corner Hinge

Type	Swing	Attach	35mm Cup 11mm Depth	Cup Width	Cup Depth	Box Quantity
45 Degree Corner	Soft Closing	Dowel	65C7R6ME9AC	35mm	13mm	150
Blind Corner Overlay	Soft Closing	Dowel	65C7R6NE9AM	35mm	13mm	150
Blind Corner Inset	Soft Closing	Dowel	65C7R6NE9AC	35mm	13mm	150

### Salice Hinge Boring and Insertion Machine



Call us if you are looking for a new hinge machine and talk to us about a customized purchase program based either on hinge volume or direct monthly payment program. We know the machine will work for you, but the way you pay for it must work also.

Available Models:

- 6502TOM1C216 220v/ 1 Phase Pneumatic
- 6501TOM1C236 220v/ 3 Phase Pneumatic
- 6504 110v/ Single Phase Manual
- 6504TOMINI 110v/ 1 Phase/ 60 Mini Pneumatic
- 6503TOMIC110 110v/ 1 Phase Pneumatic
- (6504 Not Pictured)

Rams available for Blum Machines

### Salice Glass Door Hinges



26mm hole diameter.  
94 degree opening.  
For use with glass from 4mm to 6mm thickness.  
Possible drilling distance to the door: 5.5 to 6.5 mm.  
Compatible with all traditional Series 200 mounting plates  
and with all DOMI snap-on mounting plates.  
Please contact U.S. Industrial Fasteners for more information.

### Salice Institutional 270 Degree Hinge



Swing	Attach	Degree	Cup Width	Cup Depth	Full Overlay	Box Quantity
Self Closing	Dowel	270	35mm	12mm	65CMR3A99	100



European Hinges - Salice  
Salice 37 x 32 Mounting Plates



Attach	Type	0mm	2mm	3mm	6mm	9mm	12mm	18mm	Box Quantity
Screw In	Steel	65B2V3H09		65B2V3H39	65B2V3H69		65B2V3BC9 Die-Cast		600
Euro Screw Pre-Inserted	Steel	65B2VGH09		65B2VGH39					600
Screw In	Die-Cast Adjustable	65B2R3E09		65B2R3E39		65B2R3E99			600
Euro Screw Pre-Inserted	Die-Cast Adjustable	65B2RGE09		65B2RGE39	65B2RGE69				600
Screw In	Die-Cast	65BAV3E09		65BAV3E39		65BAV3E99		65BAV3EV9 Die-Cast	300
Euro Screw Pre-Inserted	Die-Cast					65BAVGE99	65BAVGEC9		300
Euro Screw Pre-Inserted	Steel	65BAVGL09							300
Euro Screw Pre-Inserted	Economy Steel	65BAVGM09		65BAVGM39					300
Screw In	Die-Cast	65BAR3R09	65BAR3R29	65BAR3R39	65BAR3R69		65BAR3RC9		300
Euro Screw Pre-Inserted	Die-Cast	65BARGR09	65BARGR29	65BARGR39	65BARGR69	65BARGR99		65BARGRV9	300
Euro Screw Pre-Inserted	Steel	65BARGL09		65BARGL39					300

Attach	Type	21mm	24mm	Box Quantity
Euro Screw Pre-Inserted	Die-Cast	65BARGRY9	65BARGRZ9	150

\*Also available are Salice pozi pan head euro screws for Salice mounting plates, Part Number 65V236X144.





Slide-On



Clip-On



Inset

Type	1mm	4mm	6mm	Box Quantity
Clip-On Steel	65BAU3L19	65BAU3L49		300
Cam Adjustable Clip-On Die-Cast	65BAU3R19	65BAU3R49	65BAU3R69	300
Inset Clip-On Die-Cast	65BAL3R59			300

Straight Mounting Plates



Type	0mm	2mm	3mm	Box Quantity
Euro Screw Pre-Inserted	65BAPGR09	65BAPGR29	65BAPGR39	300

Double Cam - Large Overlay Face Frame Application - Mezz Inset Plate



Type	Inset	Box Quantity
Screw In	65BAM3R09	300

Angle Mounting Plates



15 Degree



7.5 Degree



10-30 Degree

Type	15 Degree	7.5 Degree	10-30 Degree	Box Quantity
Screw In	65B2V3BW9	65B2V3BW9R	65B2V3BW9S	300

Angle Mounting Plate Adapters



Type	5 Degree	10 Degree	Box Quantity
Adapter	65SAV354X9R	65SAV354X9S	50



**Salice Push To Open**



Adapter with depth and sideways adjustment.  
Release device for adapter.  
Please contact U.S. Industrial Fasteners for more information.

\*Non-magnetic touch latch available see page 120.

**Salice Smove System**

**Smove**



Part Number	Action Type	Color	Box Quantity
65D005SNB	Light	Beige	250
65D006SNB	Medium	Beige	250
65D008SNB	Strong	Beige	250

**Adapters**



Part Number	Applications	Color	Box Quantity
65D065SNBR	Inset Doors, Drawers and Special	Beige	500
65D066SNBN	Face Frame	Beige	250
65D067SNBN	S Series Face Frame	Beige	250

**Salice Smove**

**Universal Smove for Face Frame**



Smove for Face Frame  
Universal  
Packed 150 per Box

Part Number: 65D0LHSNG

**Smove Adapters**

Use with the BAR (die-cast) family mounting plates.

Choose the assembly adapter to work with the Clip On Smove for your specific applications.



Clip On Smove

Part Number	Type	For	Box Quantity
65DARX09	Adapter	Full Overlay Hinges	300
65DARX99	Adapter	Half Overlay Hinges	300
65DARXP9	Adapter	Inset Hinges	150
65D0SHSNG	Clip On Smove	Adapters (Small Doors)	300
65D0S8SNG	Clip On Smove	Adapters (Large Doors)	300

**Push Latch - Titus**



Push latch with linear plate.  
Non-magnetic.  
Packed 200 sets per Box.

Part Number: 679150X59381K2



Reduction Clip



Reduction clip reduces a 94 degree opening to a 86 degree opening  
Packed 50 per Bag

Part Number: 65S2A637XF

Pozi Screwdriver



Packed 2 per Box

Part Number: 6509

Reduction Clips for Compact Hinges



Reduction clip that reduces opening to 86 degree opening.

Part Number	For	Box Quantity
65SSP3377G	CSR Hinges 1/4" - 3/4"	50
65SSP337AG	CSR Hinges 1" - 1 9/16"	50
65SUP337XG	CUR Hinges	50

Also available are the Salice screw for 8mm dowel and the Salice 8mm dowel.

Face Frame Hinge Spacer

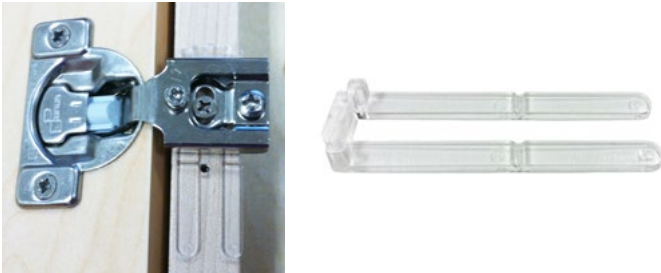

1.5mm Face Frame Hinge Spacer  
Stocked in Clear.  
Packed 250 per Box.

Part Number: 714419023CL

Face Frame Hinge Spacer



1/32" Face Frame Hinge Spacer  
Stocked in Zinc.  
Packed 600 per Box.

Part Number: 7144B6335015

Salice Hinge Spacer



1.2mm Hinge Spacer for Soft Close Hinges.  
Stocked in Clear.  
Packed 100 per Box.

Part Number: 65S2XX86AT

Concealed Hinge Repair Kit



Fits 26mm and 35mm Hinges (1 Door)













For Kitchen, Bedroom, Bathroom, Office and Similar Cabinets.

Kit contains:  
2 - White Hinge Repair Plastic Part  
12 - 6mm x 16mm Phillips Flat Euro Screw  
Installation Instructions









Part Number: 73CHRK2635RWT

SALICE HINGE QUICK REFERENCE TO COMMON OVERLAY APPLICATIONS

**Overlay: Frameless Cabinet** Using 4mm ( 5/32")TAB Distance (K)

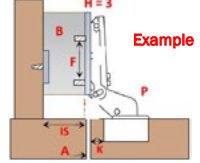
What is TAB (K) Distance? 	Hinge Overlay Choices				★ Indicates preferred choice
	Full Overlay Hinge	1/2" Overlay Hinge	Half (3/8") Overlay Hinge	Inset Hinge	
Mounting Plate Thickness Choices ↓	 "A"	 "D"	 "G"	 "P"	Desired Overlay
 0mm	3/4" Overlay 19mm	9/16" Overlay 14mm	★ 3/8" Overlay 10mm		
 2mm	11/16" Overlay 17mm	1/2" Overlay 12.5mm	★ 5/16" Overlay 8mm	Inset Door Plus Adjustment	
 3mm	5/8" Overlay 16mm	7/16" Overlay 11mm	★ 9/32" Overlay 7mm (Plus Adjustment)	★ Inset Door	
 6mm	★ 1/2" Overlay 12.5mm	5/16" Overlay 8mm	5/32" Overlay 4mm		
 9mm	3/8" Overlay 10mm	3/16" Overlay 5mm (Plus Adjustment)	Inset Door Plus Adjustment		
 12mm	1/4" Overlay 6mm	3/32" Overlay 2mm (Plus Adjustment)	Inset Door		
 18mm	Inset Door Plus Adjustment				

**Overlay: Face Frame Cabinet** Using 4mm (5/32") TAB Distance (K)

1" = 25.4mm Mounting Plate Thickness Choices ↓	Hinge Overlay Choices				★ Indicates preferred choice
	Full Overlay Hinge	1/2" Overlay Hinge	Half (3/8") Overlay Hinge	Inset Hinge	
 "A"	 "D"	 "G"	 "P"	Desired Overlay	
 1mm	3/4" Overlay 19mm	1/2" Overlay 12.5mm	★ 3/8" Overlay 10mm 5/16" Overlay (3mm Tab)		For inset doors, on face frame cabinets, using a "P" style hinge, refer to the "SAP" mounting plate system chart. 
 4mm	9/16" Overlay 15mm	3/8" Overlay 10mm	1/4" Overlay 6mm ★ 5/16" Overlay (5mm Tab)		
 BAL3R59		Inset Door (Use 3mm Tab)	★ Inset Door		
 BAM3R09	1 1/4" Overlay 32mm (Use 6mm Tab (K))				

**Remaining Steps To Complete Hinge & Mounting Plate Selection**

1. Select the angle of opening of the hinge. 94 Degree 110 Degree 120 Degree 155 degree 165 Degree	Adjustment Range			
2. Select the fixing method to attach the hinge to the door. Screw-on Press-in dowel Rapido Logica				
3. Select hinge closing style. Self closing Soft Closing "Silentia" Self Opening "Push" Free swinging				
4. Select mounting plate grade: Premium (2 cam adjustment) Economy (1 cam adjustment)				
5. Select fixing method to attach the mounting plate to the cabinet. Wood screw Euro screw Expanding dowel				
6. For "Silentia" hinges: Verify cup boring depth with customer: Series 100 = <b>12mm</b> Series 200 = <b>15.5mm</b> Series 700 = <b>13.5mm</b>				
7. For "Push" hinges: Select a release device style: Mechanical release device Magnetic release device				
<b>Finding The Mounting Plate Thickness In The Part Number</b>				
BAR3R09 = 0mm thick	BAR3R39 = 3mm thick	BAR3R99 = 9mm thick	BAR3RV9 = 18mm thick	BAU3R49 = 4mm thick
BAR3R29 = 2mm thick	BAR3R69 = 6mm thick	BAR3RC9 = 12mm thick	BAU3R19 = 1mm thick	BAL3R59 = 5mm thick

## Nexis Hinges - 35mm Cup, 45mm Hole Pattern



Opening angle 110°.  
3-dimensional adjustment.  
For face frame and frameless cabinets.  
Soft close compatible, see page 8.  
All metal hinge, nickel plated.

Part Number	Swing	Degree	Attach	Type	Cup	Box Quantity
GR148322540015	Self Closing	110	B45 Dowel	Full Overlay	35mm Cup 11mm Cup Depth	125
GR146622500815	Self Closing	110	Twin Tooless	1/2 Overlay	35mm Cup 11mm Cup Depth	125

## Nexis Hinges - 35mm Cup, 42mm Grass Hole Pattern



3 dimensional adjustment: side, depth, and height.  
Cam height and depth adjustment with select base plates.  
Stamped steel arm and cup with bright nickel finish.  
Soft close compatible, see page 8.

Part Number	Swing	Degree	Attach	Type	Cup	Box Quantity
GR6803314	Self Closing	125	G42 Dowel	Full Overlay	35mm Cup 11.8mm Cup Depth	125

## Grass Mounting Plates

For use with all grass hinges shown above.



314393810015



314493710015

Attach	Type	0mm	2mm	Box Quantity
Screw In	Steel	GR314393810015		250
Euro Screw Short Pre-Inserted	Steel	GR346393921015		250
Screw In	Steel 3-D Adjustable	GR314493710015	GR314493710215	250
Euro Screw	Steel Adjustable	GR318393690015		250

## Grass Face Frame Mounting Plates

For use with all grass hinges shown above.



346290880415

Attach	Type	4mm	Box Quantity
Screw In	Steel	GR346290880415	250





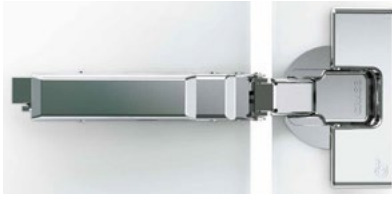

**Features:**

- \* Maximum stability
- \* Adjustable soft-close dampening
- \* Damper technology is concealed within the hinge arm
- \* For door thickness from 14mm to 24mm
- \* 3-dimensional adjustment with suitable base plate

**110 Degree Hinges**



3-dimensional adjustment with suitable base plate.

Accommodates overlays up to 24mm (15/16")  
Optimal reveal up to 24mm door thickness.  
Soft Close or Self Close hinges available.  
For Face Frame or Frameless cabinets.  
Convenient depth adjustment with worm gear.  
All hinges available in Impresso.

Part Number	Swing	Degree	Attach	Type	Cup	Box Quantity
GRF028138523228	Soft Closing	110	Dowel	Full Overlay	35mm Cup 12.6mm Cup Depth	150
GRF028138525228	Soft Closing	110	Dowel	1/2 Overlay	35mm Cup 12.6mm Cup Depth	150
GRF01713941622	Soft Closing	110	Impresso	1/2 Overlay	35mm Cup 12.6mm Cup Depth	150

Part Number	Swing	Degree	Attach	Type	Cup	Box Quantity
GRF045138461228	Self Closing	110	Dowel	Full Overlay	35mm Cup 12.6mm Cup Depth	150
GRF045138463228	Self Closing	110	Dowel	1/2 Overlay	35mm Cup 12.6mm Cup Depth	150

**160 Degree Hinges**



3-dimensional adjustment with suitable base plate  
Accommodates overlays up to 25.4mm (1")  
Soft Close or Self Close hinges available  
For Face Frame or Frameless cabinets  
Convenient depth adjustment with worm gear  
Zero protrusion when door is opened 90 degrees  
For door thicknesses up to 32mm (1 1/4")  
Minimal reveal

Part Number	Swing	Degree	Attach	Type	Cup	Box Quantity
GRF017139437217	Soft Closing	160	Impresso	1/2 Overlay	35mm Cup 12.6mm Cup Depth	50

**Reduction Clip**



Works for all Tiomos 110 and 120 degree standard hinges.  
Reduces the opening angle to 85 degree.

Part Number: GRF072135751517



## Grass Tiomos Hinge System

### Mounting Plates



Wing steel base plate, 3 point fixing.  
With pre-mounted euro screws (13.5mm).

Attach	Type	0mm	3mm	Box Quantity
Pre Mounted Euro Screw	Steel Adjustable	GRF058139736228	GRF058139738228	150

### Mounting Plates



Wing steel base plate.  
4 point fixing.  
Height adjustment via worm gear.  
150 per box

Attach	0mm	2mm	3mm
Screw In	GRF058139746228	GRF058139747228	GRF058139748228
Euro Screw	GRF058139761228	GRF058139762228	GRF058139763228
Short Euro Screw (10mm)	GRF058139863228		GRF058139865228

### Face Frame Mounting Plates



FFA base plate, 2 point fixing.

Attach	Type	1.5mm	4.5mm	Box Quantity
Screw In	Steel Adjustable	GRF058139821228	GRF058139823228	150

## Soft Close

### UniSoft Pro

Works for all face frame cabinets on all door overlays.  
Works for frameless cabinets on full overlay doors.



UniSoft Soft Close Adapter for Doors  
Packed 250 per Box.

Part Number: GR1897414

## Import Soft Close Hinges 35mm Cup, 11mm Depth



Full Overlay



Half Overlay

Overlay	Swing	Attach	110 Degree	Box Quantity
Full	Soft Closing	Dowel	PR33118DSC	200
Half	Soft Closing	Dowel	PR33228DSC	200
Inset	Soft Closing	Dowel	PR33338DSC	200

## Import Soft Close Mounting Plates Steel Clip On



Face Frame

Attach	Type	0 mm	3mm	Box Quantity
Euro Pre-Inserted	Soft Closing	PR3300S		200
Screw In	Clip-On Soft Closing	PR3300		200
Screw In	Face Frame Soft Closing	PR3300SC	PR3303SC	200

Import Soft Close Mounting Plates  
Cam Adjustable



Attach	Type	2mm	4mm	Box Quantity
Euro Pre-Inserted	Soft Closing	PR96T02TQ	PR96T42TQ	200

Import Self Closing Hinges  
35mm Cup, 11mm Depth

110 Degree Self Closing Hinges



Full Overlay

Half Overlay

Overlay	Swing	Attach	110 Degree	Box Quantity
Full	Self Closing	Screw In	PRH633ACL	200
Half	Self Closing	Screw In	PRH633BCL	200
Inset	Self Closing	Screw In	PRH633CCL	200
Full	Self Closing	Dowel	PRH634ACL	200
Half	Self Closing	Dowel	PRH634BCL	200

120 Degree Self Closing Hinges



Overlay	Swing	Attach	120 Degree	Box Quantity
Full	Self Closing	Dowel	PRH659ACL	200
Half	Self Closing	Dowel	PRH659BCL	200

165 Degree Self Closing Hinges



Overlay	Swing	Attach	165 Degree	Box Quantity
Full	Self Closing	Dowel	PRH52ACL	200

Import Face Frame Plate



FCL



FCLS

Type	0 mm 5/8 Overlay	3 mm 1/2 Overlay	6 mm 3/8 Overlay	Box Quantity
Face Frame Die-Cast	PRFCL0	PRFCL3		200
Face Frame	PRFCLS0	PRFCLS3	PRFCLS6	200

Import Cam Adjustable Die-Cast  
Clip On Plate



Attach	Type	0 mm	2 mm	Box Quantity
Euro Pre-Inserted	Cam Adjustable	PRT02TQ		200
Screw In	Cam Adjustable	PRT00TQ	PRT20TQ	200
Euro Dowel	Cam Adjustable	PRT0CTQ	PRT2CTQ	200



Attach	0 mm	2 mm	4 mm	Box Quantity
Euro Pre-Inserted		PRCLK2S	PRCLK4S	200
Short Euro Pre-Inserted	PRCLK0S12			200
Screw In	PRCLK0	PRCLK2		200

Recommended Screws for Face Frame Hinges



Size	Head Type	Thread Type	Part Number	Box Quantity
8 x 3/4	Phillips Round Washer	Coarse Thread Type 17	016608120917	10,000



**Salice Face Frame 106 Degree Hinges**



35mm Cup 11mm Depth

Zero door protrusion from 1/2" to 1 7/16" overlay.

Overlay	Attach	Part Number	Box Quantity
1/4"	Dowel	65CSR3Y99	300
1/2"	Screw In	65CSP3799	300
1/2"	Dowel	65CSR3799	300
5/8"	Dowel	65CSR3599	300
3/4"	Dowel	65CSR3499	300
1"	Dowel	65CSR3299	300
1 1/4"	Dowel	65CSR3A99	300
1 7/16"	Dowel	65CSR3D99	300

**Salice Face Frame 106 Degree Hinges 6 Way Cam Adjustable**

Available Upon Request.



35mm Cup 11mm Depth

Zero door protrusion from 1/2" to 1 7/16" overlay.

Overlay	Attach	Part Number	Box Quantity
1/2"	Dowel	65CSR3799XR	300
9/16"	Dowel	65CSR3699XR	300
5/8"	Dowel	65CSR3599XR	300
3/4"	Dowel	65CSR3499XR	300
1"	Dowel	65CSR3299NR	300
1 1/4"	Dowel	65CSR3A99NR	300
1 3/8"	Dowel	65CSR3C99NR	300
1 7/16"	Dowel	65CSR3D99NR	300

**Salice Compact Soft Close Face Frame Hinges**



35mm Cup 11mm Depth

Zero door protrusion from 1/2" to 1 9/16" overlay.

Overlay	Attach	2 Cam Adjustable Part Number	3 Cam Adjustable Part Number	Box Quantity
1/2"	Dowel	65CUR37D9	65CUR37D9R	300
5/8"	Dowel		65CUR35D9R	300
3/4"	Dowel	65CUR34D9	65CUR34D9R	300
1"	Dowel		65CUR32D9R	300
1 1/4"	Dowel	65CUR3AD9	65CUR3AD9R	300
1 3/8"	Dowel		65CUR3CD9R	300
1 9/16"	Dowel		65CUR3ED9R	300

Grass Compact Hinges



Overlay	Swing	Attach	Part Number	Box Quantity
1/2"	Self Closing	Dowel	GR0290515	300
3/4"	Self Closing	Dowel	GR0290715	300
1 1/4"	Self Closing	Dowel	GR0272915	300

Grass Compact Soft Closing Hinges

3 Stage Closing Force Adjustment



Soft close damper is premounted in the hinge cup.  
Adjustment switch to regulate closing action.

Overlay	Swing	Attach	Part Number	Box Quantity
1/2"	Soft Closing	Dowel	GR02870A15	300
3/4"	Soft Closing	Dowel	GR02875A15	300
1 1/4"	Soft Closing	Dowel	GR02910A15	300

Import Face Frame Hinges



Overlay	Swing	Attach	Part Number	Box Quantity
1/2"	Self Closing	Dowel	PRH250D	250

Import Face Frame Cam Adjustable Hinges



Overlay	Swing	Attach	Part Number	Box Quantity
1/2"	Self Closing	Screw In	PRH294	250
1/2"	Self Closing	Dowel	PRH294D	250
3/4"	Self Closing	Dowel	PRH295D	250

Import Compact Soft Close Face Frame Hinges

4 Way 2 Cam Adjustable 1 Piece Hinge



Overlay	Swing	Attach	Plate Type	Part Number	Box Quantity
1/2"	Soft Closing	Dowel	Steel	PRH294DSC	200
3/4"	Soft Closing	Dowel	Steel	PRH295DSC	200
1 1/4"	Soft Closing	Dowel	Steel	PRH297DSC	200



### Import Face Frame Hinges

#### 2 Piece Hinge



Overlay	Swing	Attach	Plate Type	Part Number	Box Quantity
3/8"	Self Closing	Dowel	Steel	IN228531	200
3/8"	Self Closing	Dowel	Die-Cast	IN228533	200
1/2"	Self Closing	Screw-In	Die-Cast	IN228550	200
1/2"	Self Closing	Dowel	Die-Cast	IN228553	200
1/2"	Soft Closing	Dowel	Steel	FRES52081BGG	200

### Drop - Leaf Hinge



1 3/16" x 3 1/4"  
Stocked in Stat Bronze.

Part Number: 7122H205LSB  
\*Recommended Screws: 8x5/8 Flat Head

### Table Flap Top Hinge



Open size 7 1/2" x 5 1/8"  
1/16" material thickness.  
Spring loaded.  
55 lb weight capacity.  
Stocked in Yellow Chromate Finish

Part Number: 7122FT22200

### Bi-Fold Hinge



2 9/16" x 2 3/8"  
Built in stop.  
Spring action with various tensions.  
Stocked in Black

Part Number: 7122FT21050

### Glass Door Hinges - Non-Bore

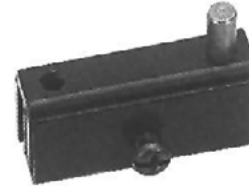

For glass thickness  
of 1/8" - 3/16"  
Grommets included.

Part Number	Height	Length	Finish	Case Quantity
7125H0200102	9/16"	1 9/16"	Bright Brass	300 pair
7125H0200102BLK	9/16"	1 9/16"	Black	300 pair

### Wood Pivot Hinges



End pivot.  
Mounts with 5x5/8 screws.

Part Number	Size	Finish	For 1 Set	Case Quantity
7104H5732L	5mm	Black	1 Left	1,000
7104H5732R	5mm	Black	1 Right	1,000
7104X301521GR	5mm	Black	2 Grommets	2,000

## Self Closing Hinges

### Face Mount



5010, 5027



5023

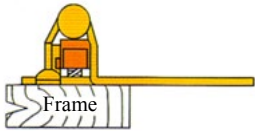

Leaf Length	Part Number	Overlay	Finish	Box Quantity	Recommended # of Screws per Pair	Recommended Size	Recommended Head Type
1 1/4	71215010BBI	Variable	Bright Brass	200 pair	6 4	6x1/2 6x5/8	Flat Oval
1 1/4	71215010AL	Variable	Almond	200 pair	6 4	6x1/2 6x5/8	Flat Oval
1 1/4	71215010WH	Variable	White	200 pair	6 4	6x1/2 6x5/8	Flat Oval
1 3/8	71215027I	Variable	Antique Brass	200 pair	6 4	6x1/2 6x5/8	Flat Oval
1 3/8	71215027BBI	Variable	Bright Brass	200 pair	6 4	6x1/2 6x5/8	Flat Oval
1 3/8	71215027CPI	Variable	Chrome	200 pair	6 4	6x1/2 6x5/8	Flat Oval
1 3/8	71215027BLI	Variable	Black	200 Pair	6 4	6x1/2 6x5/8	Flat Oval
1 3/8	71215027DNI	Variable	Dull Nickel	200 Pair	6 4	6x1/2 6x5/8	Flat Oval
1 3/8 Slotted	71215023I	Variable	Antique Brass	200 pair	4 4	6x1/2 6x5/8	Pan Oval
1 3/8 Slotted	71215023BBI	Variable	Bright Brass	200 pair	4 4	6x1/2 6x5/8	Pan Oval
1 3/8 Slotted	71215023IW	Variable	White	200 pair	4 4	6x1/2 6x5/8	Pan Oval

Screws available in Fine Thread and Coarse Thread.

### Partial Wrap



Leaf Length	Part Number	Overlay	Finish	Box Quantity	Recommended # of Screws per Pair	Recommended Size	Recommended Head Type
1 3/8 Slotted	71216423BBI	1/2"	Bright Brass	100 pair	4 4	6x1/2 6x5/8	Pan Pan

Screws available in Fine Thread and Coarse Thread.

### Amerock Self Closing Hinges



Available in all colors.  
Special order only.



## Self Closing Hinges

Full Wrap 3/4"

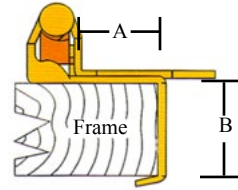

Leaf Length	Part Number	Overlay	Finish	Box Quantity	Recommended # of Screws per Pair	Recommended Size	Recommended Head Type
1 1/4	71219010BBI	A = 1/2 B = 3/4	Bright Brass	100 pair	6 2	6x1/2 6x5/8	Flat Pan
1 1/4	712190010I	A = 1/2 B = 3/4	Antique Brass	100 pair	6 2	6x1/2 6x5/8	Flat Pan
1 3/8 Slotted	71219023I	A = 1/2 B = 3/4	Antique Brass	100 pair	4 4	6x1/2 6x5/8	Pan Pan
1 3/8 Slotted	71219023BBI	A = 1/2 B = 3/4	Bright Brass	100 pair	4 4	6x1/2 6x5/8	Pan Pan

Screws available in Fine Thread and Coarse Thread.

## Invisible - Solid Brass Hinges



Part Number	Length	Barrel Diameter	Depth of Bore	Minimum Wood Thickness	Box Quantity
7124H0305010BRS	22mm	10mm	11mm	1/2"	10

## Shutter Hardware

### Solid Brass Ball Catches

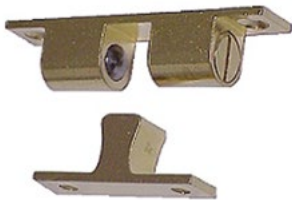

Strike Included  
 1 3/4" Brass  
 Part Number: 7125M034400B  
 2" Brass  
 Part Number: 7125M034900B  
 58mm Dull Chrome  
 Part Number: EP1013DC  
 Packed 100 Sets per Box

### Springs



Length 13/16"	Length 5/8"
Diameter 3/16"	Diameter 7/32"
# of Coils 8	# of Coils 11
Packed 1,000 per Box	Packed 1,000 per Box
Part Number: 7144510	Part Number: 7144520

### Round Mortise 9 lb

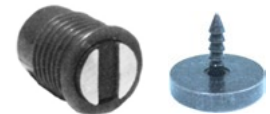

9/16" Diameter, Brown  
 Part Number: 7125M0303917  
 14mm Diameter, Brown  
 Part Number: 6357273901  
 Strike Part Number: 7125M0302908  
 Packed 1,000 per Case

\*Recommended Screws: 4x5/8 Flat Head



Shutter Hardware

Hidden Tilt Rod



Part Number	Length	For Louver Size	Color	Box Quantity
JG96A2W	96"	2 1/2"	White	50
JG96A2B	96"	2 1/2"	Brown	50
JG96A3W	96"	3 1/2"	White	50
JG96A3B	96"	3 1/2"	Brown	50
JG96A4W	96"	4 1/2"	White	50
JG96A4B	96"	4 1/2"	Brown	50

Receiver Catch and Button Set

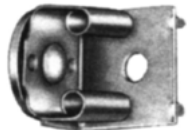

Catch



Button

Part Number	Color	Box Quantity
7125BSHC2BP	Brass	100
7125BSHC2WH	White	100
7125BSHC2ZP	Zinc	100

Elbow Catches



Aluminum  
Part Number: 7125M0399389



Zinc  
Part Number: 7125M0399389ZN  
Packed 50 Sets per Bag

\*Recommended Screws:  
6x5/8 Pan Head

Internal Spring Roller Catch



Stat Bronze  
Packed 100 Sets per Box.  
Part Number: 7125M0399388SB  
\*Recommended Screws: 6x5/8  
Pan Head

Shutter Hardware

Hi Rise Single Magnetic Catch 8#



Part Number	Color	Box Quantity
7125M0303932	Brown	250

Double Magnetic Catch 8#

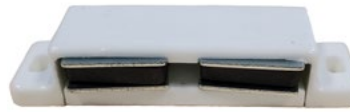

Part Number	Color	Box Quantity
7125M0303941W with Strike & Screws	White	100

Single Magnetic Catch 13#



Part Number	Color	Box Quantity
732462610443	Brown	100
7324626300	Black	100

Single Magnetic Catch 13#



Part Number	Color	Box Quantity
7125M02X3921 with Strike & Screws	White	500
7125M02X3921BR with Strike & Screws	Brown	500

High Profile Single Magnetic Catch 25#



Part Number	Color	Box Quantity
7125M0303950	Brown	100
7125M0203950W with Strike & Screws	White	100



## Shutter Hardware

### Aluminum Single Magnetic Catch 15#



Part Number	Color	Box Quantity
7125M0303949 with Strike	Aluminum	100

### Single Magnetic Catch



Part Number	Color	Box Quantity
EP591 with Strike & Screws	Aluminum	100



### Recommended Screws

4x5/8 Phil Pan TSA for all catches.

### Striker Plates



Part Number	Size	Color	Box Quantity
7125M040290102	22mm x 30mm	Zinc	4,000
7125M0402901	22mm x 30mm	Stat Bronze	4,000



21mm H x 26mm L  
Stocked in Stat Bronze Only.  
Packed 5,000 per Box.

Part Number: 6357280001



### Recommended Screws

5x1/2 Phil Flat Head TSA.

## Shutter Hardware

### Shutter Pins

Shutter  
Hardware

#### Shutter Pin



Pin Diameter: .140  
Head Diameter: .240  
Full Length: 1.080  
Packed 15,000 per Case

Part Number: 7144M500

#### No Shoulder Shutter Pin



Pin Diameter: .140  
Head Diameter: .240  
Full Length: 1.080  
Packed 15,000 per Case

Part Number: 7144M515

#### Spring Loaded Replacement Shutter Pin



Pin Diameter: .142  
Head Diameter: .242  
Full Length: .8475  
Packed 15,000 per Case

Part Number: 7144M555

#### Tension Control Pin



Pin Diameter: .140  
Head Diameter: .240  
Spring Diameter: .255  
Full Length: 1.080  
Packed 10,000 per Case

Part Number: 7144M550

#### Large Flange Bushing



Body Diameter: .240  
Inner Diameter: .180  
Full Length: .379  
Packed 5,000 per Case

Part Number: 7144M540

#### Nylon Washer



Inner Diameter: .171  
Outer Diameter: .312  
Thickness: .031  
Packed 5,000 per Case

Part Number: 42030638S

## Shutter Hardware Loose Pin Mortise Type Hanging or Interpanel Hinges

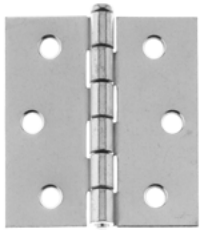
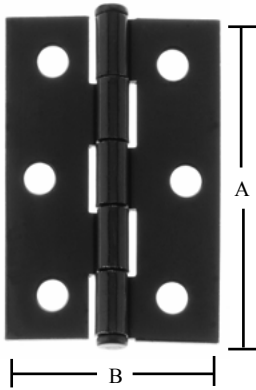

Full Swage



Half Swage



Flat Back

Part Number	Size	Length (A)	Open Width (B)	Swage	Recommended Screw	Box Quantity	Color
TEH0357451664	1 3/4" x 2"	2"	1 3/4"	Full	6x5/8 Flat	400	White
TEH0357451674	1 3/4" x 2"	2"	1 3/4"	Full	6x5/8 Flat	400	Cottage White
TEH03574519R4	1 3/4" x 2"	2"	1 3/4"	Full	6x5/8 Flat	400	Oil Rubbed Bronze
TEH0357451154	1 3/4" x 2"	2"	1 3/4"	Full	6x5/8 Flat	400	Satin Nickel
TEH0357551054	2" x 2"	2"	2"	Full	6x5/8 Flat	400	Antique Brass
TEH0351251034	1 1/2" x 2 1/2"	2 1/2"	1 1/2"	Full	6x5/8 Flat	400	Bright Brass
TEH0351251054	1 1/2" x 2 1/2"	2 1/2"	1 1/2"	Full	6x5/8 Flat	400	Antique Brass
TEH0351251154	1 1/2" x 2 1/2"	2 1/2"	1 1/2"	Full	6x5/8 Flat	400	Satin Nickel
TEH0351251664	1 1/2" x 2 1/2"	2 1/2"	1 1/2"	Full	6x5/8 Flat	400	White
TEH0351251674	1 1/2" x 2 1/2"	2 1/2"	1 1/2"	Full	6x5/8 Flat	400	Cottage White
TEH03512519R4	1 1/2" x 2 1/2"	2 1/2"	1 1/2"	Full	6x5/8 Flat	400	Oil Rubbed Bronze
TEH0355451034	1 11/16" x 2 1/2"	2 1/2"	1 11/16"	Full	6x5/8 Flat	400	Bright Brass
TEH0357651034	2" x 2 1/2"	2 1/2"	2"	Full	6x3/4 Flat	400	Bright Brass
TEH0357651124	2" x 2 1/2"	2 1/2"	2"	Full	6x3/4 Flat	400	Primer
TEH0357651664	2" x 2 1/2"	2 1/2"	2"	Full	6x3/4 Flat	400	White
TEH03576519R4	2" x 2 1/2"	2 1/2"	2"	Full	6x3/4 Flat	400	Oil Rubbed Bronze
TEH0357751034	2 1/2" x 2 1/2"	2 1/2"	2 1/2"	Full	6x3/4 Flat	400	Bright Brass
TEH0357751664	2 1/2" x 2 1/2"	2 1/2"	2 1/2"	Full	6x3/4 Flat	400	White
TEH03577519R4	2 1/2" x 2 1/2"	2 1/2"	2 1/2"	Full	6x3/4 Flat	400	Oil Rubbed Bronze

\*Screws are available in different finishes Please see pages 204 and 211 for more information.



# Shutter Hardware

## Round Cornered Hinges



Part Number	Length (A)	Width (B)	Material Thickness	Pin Diameter	Swage	Recommended Screw	Case Quantity	Case Weight	Finish
7124H0325801	2 1/2"	2"	0.065	0.12	Full	6x3/4 Flat	400	60#	Bright Brass
7124H0325801P	2 1/2"	2"	0.065	0.12	Full	6x3/4 Flat	400	60#	Primer

### Nonmortise Hinges Tight Pin

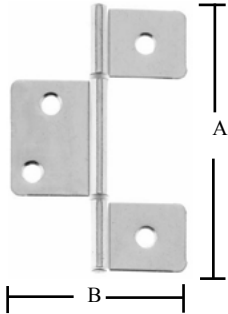

Part Number	Length (A)	Width (B)	Material Thickness	Pin Diameter	Swage	Recommended Screw	Case Quantity	Case Weight	Finish
7124H0303970	3 1/2"	2 1/4"	0.05	0.12	Full	6x5/8 Flat	500	89#	Bright Brass
7124H0303970AB	3 1/2"	2 1/4"	0.05	0.12	Full	6x5/8 Flat	500	89#	Antique Brass
7124H0303970BZ	3 1/2"	2 1/4"	0.05	0.12	Full	6x5/8 Flat	500	89#	Rubbed Bronze
7124H0303970NKL	3 1/2"	2 1/4"	0.05	0.12	Full	6x5/8 Flat	500	89#	Nickel
7124H0303970WH	3 1/2"	2 1/4"	0.05	0.12	Full	6x5/8 Flat	500	89#	White

### Nonmortise Hinges

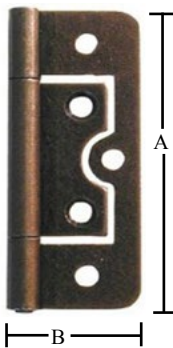

Part Number	Length (A)	Width (B)	Material Thickness	Pin Diameter	Pin Type	Swage	Recommended Screw	Case Quantity	Case Weight	Finish
7124H0303205SB	2 1/2"	3/4"	0.054	0.098	Tight	Flat Back	5x5/8 Flat	1,000	56#	Stat Bronze
7124H0303305SB	3"	13/16"	0.064	0.102	Tight	Flat Back	5x5/8 Flat	500	49#	Stat Bronze
7124HR9802CW	3"	1"	0.060	0.150	Loose	Full	6x5/8 Flat	250	50#	Cottage White
7124HR9802AB	3"	1"	0.060	0.150	Loose	Full	6x5/8 Flat	250	50#	Antique Brass
7124HR9802BC	3"	1"	0.060	0.150	Loose	Full	6x5/8 Flat	250	50#	Brushed Chrome
7124HR9802BN	3"	1"	0.060	0.150	Loose	Full	6x5/8 Flat	250	50#	Bright Nickel
7124HR9802BWH	3"	1"	0.060	0.150	Loose	Full	6x5/8 Flat	250	50#	White
7124HR9802DACM	3"	1"	0.060	0.150	Loose	Full	6x5/8 Flat	250	50#	Oil Rubbed Bronze
7124HR9802PB	3"	1"	0.060	0.150	Loose	Full	6x5/8 Flat	250	50#	Bright Brass



Terry Hinge - Shutter Hardware  
Double Wrap-A-Round Hinges

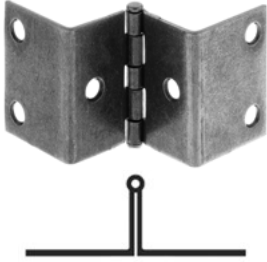

Part Number	Length	Door Thickness	Material Thickness	Pin Diameter	Return	Recommended Screw	Case Quantity	Case Weight	Finish
7124H0363F53ABC	1 1/2"	5/8"	0.05	0.098	1 1/4"	5x5/8 Flat	300	37#	Antique Brass Crimped

Wrap Hinges

270 Degree of Opening



Part Number	Size	Finish	Recommended Screw	Case Quantity
7124H089MX83BLK	5/8" x 5/8" x 2"	Black	6x3/4 Flat	200
7124H089MX83	5/8" x 5/8" x 2"	Bright Brass	6x3/4 Flat	200

Institutional Hinges



2 3/4" Five Knuckle hinge  
.095 Steel  
Hospital Tips

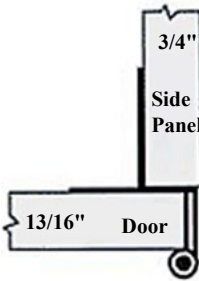

Part Number	Size	Side Panel	Door Thickness	Overlay	Brand	Designed For	Finish	Recommended Screw	Box Quantity
712385626D	2 3/4"	3/4"	13/16"	23/32"	RPC	32mm System	Chrome	8x3/4 Flat	100
7123856SGB	2 3/4"	3/4"	13/16"	23/32"	RPC	32mm System	Glass Black	8x3/4 Flat	100
7123H76045DC	2 3/4"	3/4"	13/16"	23/32"	Import	32mm System	Dull Chrome	8x3/4 Flat	100
7123H760GBK	2 3/4"	3/4"	13/16"	23/32"	Import	32mm System	Gloss Black	8x3/4 Flat	100
712345626D	2 3/4"	3/4"	13/16"	23/32"	Import	32mm & 45mm System	Satin Chrome	8x3/4 Flat	100
712345426D	2 3/4"	3/4"	3/4"	23/32"	RPC	32mm System	Dull Chrome	8x3/4 Flat	100

Terry Hinge - Sheared Pin Butt Hinges



Part Number	Length	Open Width	Material Thickness	Pin Diameter	Swage	Recommended Screw	Case Quantity	Case Weight	Finish
7104H931112ZN	1 1/2"	1 1/2"	0.042	0.09	Flat	5x5/8 Flat	400	14#	Zinc
7124H0330200	1 1/2"	1 3/8"	0.042	0.09	Flat	5x5/8 Flat	400	14#	Bright Brass



## Tight Pin Butt Hinges



Part Number	Length	Open Width	Swage	Recommended Screw	Case Quantity	Case Weight	Finish
7124H0350454MAB	2 1/2"	1 9/16"	Full	6x5/8 Flat	400	34#	Antique Brass with Minaret
7124H0340753	2 1/2"	2"	Full	6x5/8 Flat	500	48#	Bright Brass
7124PRH0054AB	2 1/2"	1 5/8"	Full	6x5/8 Flat	500	44#	Antique Brass
7124PRH0054BK	2 1/2"	1 5/8"	Full	6x5/8 Flat	500	44#	Black

## Large Butt Hinges

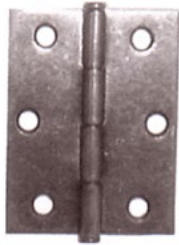

Part Number	Length	Width	Finish	Recommended Screw	Case Quantity
7122282806R	3"	3"	Bright Brass	8x3/4 Flat	100

## Piano Hinges

Plated Countersunk Holes 2 Inch Centers Cut In Length



Part Number	Open Width	Effective Leaf Width	Material Thickness	Pin Diameter	Pin Material	Joint Length	Flat Head Screw Hole Size	Finish	Stock Size Feet
7124CP23301S	1 1/16"	0.4428	0.040	0.091	Steel	1/2"	4	Brass	6
7124CP23303S	1 1/2"	0.6615	0.040	0.091	Steel	1/2"	5	Brass	6
7124CP23305S	2"	0.9105	0.040	0.091	Steel	1/2"	5	Brass	6
7124CP26103S	1 1/2"	0.6615	0.040	0.091	Steel	1/2"	5	Stat Bronze	6
7124CP22203S	1 1/2"	0.6615	0.040	0.091	Steel	1/2"	5	Nickel	6
7124CP22205S	2"	0.9105	0.040	0.091	Steel	1/2"	5	Nickel	6
7124CA21003A7*	1 1/2"	0.6615	0.040	0.091	Aluminum	1/2"	5	Aluminum	7

\*Denotes Staggered Hole Pattern

## Plated Holes 2 3/8 Inch Centers in 100 Foot Coils

Part Number	Open Width	Effective Leaf Width	Material Thickness	Pin Diameter	Pin Material	Joint Length	Flat Head Screw Hole Size	Stock Finish
7124CP63303S	1 1/2"	0.677	0.0315	0.065	Steel	5/8"	5	Brass



Salice Wind Soft Close Lift System

Lifts

New Wind soft close lift systems from Salice.



Spring	Minimums	Maximums
W Spring	Min Door Weight: 1.75 lbs Min Door Height: 8 5/8"	Max Door Weight: 11.5 lbs Max Door Height: 12 9/16"
D Spring	Min Door Weight: 4 lbs Min Door Height: 8 5/8"	Max Door Weight: 17 lbs Max Door Height: 24"
I Spring	Min Door Weight: 10.5 lbs Min Door Height: 12 9/16"	Max Door Weight: 21 lbs Max Door Height: 24"
F Spring	Min Door Weight: 18.5 lbs Min Door Height: 12 9/16"	Max Door Weight: 32 lbs Max Door Height: 24"
S Spring	Min Door Weight: 26 lbs Min Door Height: 12 9/16"	Max Door Weight: 41 lbs Max Door Height: 24"

Part Number	Spring	Box Quantity
65FRAKFEXWSN9	W	1 set
65FRAKFEXDSN9	D	1 set
65FRAKFEXISN9	I	1 set
65FRAKFEXFSN9	F	1 set
65FRAKFEXSSN9	S	1 set

Cover Sets

Part Number	Color	Box Quantity
65SRXA78AMSNXXF	Gray	1 set
65SRXA78A1SNXXF	White	1 set
65SRXA78AiSNXXF	Steel	1 set

\*Available in Push.

Kinvaro

L-80 Parallel Lifter



Set includes: left hand and right hand lifter with door mounting brackets and gray cover caps, 1 set of spring tensions and 1 cross bar.

Part Number	For Cabinet Height	Spring	Flap Weight (lbs)
GRF152147441201	390mm - 409mm	A	4.6 - 12.1
GRF152147442201	410mm - 429mm	A	4.2 - 11
GRF152147443201	430mm - 600mm	A	4.4 - 9.9

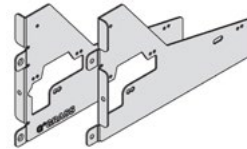

Face Frame Adapter for L-80 Right and Left with Screws. GRF151135906201

T-65 Lift Up Flap Fitting



Set includes: left hand and right hand Lifter with door mounting brackets and gray cover caps, 1 set of balance springs pre-installed, and 1 extra set of coded springs for alternate weight ranges.

Part Number	Overlay	For	Door Weight (lbs)	Door Width	Door Height
GRF151147682201	Variable	Wood	1.5 - 16.3	up to 47 1/4"	9 27/32" - 23 5/8"

T-71 Lift Up Fitting



Set includes: left hand and right hand Lifter with door mounting brackets and gray cover caps, 1 set of balance springs pre-installed, and 1 extra set of coded springs for alternate weight ranges.

Part Number	Overlay	For	Door Weight (lbs)	Door Width	Door Height
GRF151147696201	Variable	Wood	3.1 - 18.7	up to 47 1/4"	11 13/16" - 23 5/8"

**Kinvaro**

**T-76 Lift Up Fitting**



Set includes: left hand and right hand Lifter with door mounting brackets and gray cover caps and 1 set of balance springs pre-installed.

Part Number	Overlay	For	Door Weight (lbs)	Door Width	Door Height
GRF151147706201	Variable	Wood	11.5 - 24.25	up to 47 1/4"	15 3/4" - 23 5/8"

**Installation Templates**



L-80 Drilling Jig  
GR0049001



T-65 Drilling Jig  
GR0049201



T-71 & T-76 Drilling Jig  
GR0049301



Door Template Drilling Jig  
GR0049501



5mm Drill Bit  
GR0049601

**Flap Stay**



Flap Stay Nickel  
Sold Individually.

Part Number: 7104SX8519METAL

**Selby Cabinet Mounted Double and Queen Size Platform Bed Mechanism**

**Lifts**



Only the Mechanism is Included

Wood frame is built on back side of door to receive mattress or box spring. Adjustable-tension counterbalanced spring units control descent and assist ascent. Fully mounted inside cabinet, not bolted to the floor! Pivoting footrest folds inside cabinet when closed. Cabinet fastens to the wall with a small "L" bracket at top. Cabinet depth only 14"!

Twin Inside Mount - 50 kg  
Part Number: 7104XSMVO90I

Twin Outside Mount - 50 kg  
Part Number: 7104XSMVO90

Double/Queen Outside Mount - 75 kg  
Part Number: 7104XSMV05475X

Double/Queen Inside Mount - 110 kg  
Part Number: 7104XSMVO138

Double/Queen Outside Mount - 110 kg  
Part Number: 7104XSMVO138X

**Selby Horizontal Mounted Double and Queen Size Platform Bed Mechanism**



Only the Mechanism is Included

Wood frame is built on back side of door to receive mattress or box spring. Adjustable-tension counterbalanced spring units control decent and assist ascent. Fully mounted inside cabinet, not bolted to the floor! Modified to a horizontal-opening mechanism where taller cabinets are not desired. The control cylinders fasten to the sides of the platform and fit into brackets mounted inside the sidewalls of the cabinet.

85 kg  
Part Number: 7104XSMH0140X



## Lid Supports - Self Balancing Spring Loaded - Carlson Mfg.

To find inch-pounds, multiply 1/2 the distance from front to back times the weight of the lid.

### Lifts



Spring Color	Low Limit	High Limit
White	110 lbs	140 lbs
Orange	95 lbs	125 lbs
Yellow	65 lbs	95 lbs
Black	55 lbs	65 lbs
Maroon	45 lbs	55 lbs
Green	40 lbs	45 lbs
Blue	35 lbs	40 lbs
Gray	20 lbs	35 lbs

### Series 702

Inside mount support holds lid in any position. Series 702 can be ordered left or right mount.

Currently stocked in statutory bronze body with these springs:

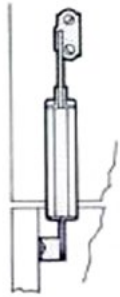

Color	Side	Part Number
Blue	Left	7153702BLL
Blue	Right	7153702BLR
Green	Left	7153702GL
Green	Right	7153702GR
Maroon	Left	7153702ML
Yellow	Left	7153702YL
Yellow	Right	7153702YR
White	Left	7153702WL
White	Right	7153702WR

### Series 703

Series 703 mounts to rear of unit (non-handed). Currently stocked in statutory bronze body with these springs:

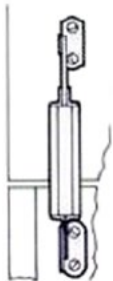

Color	Part Number
Blue	7153703BL
Orange	7153703O

### Delta Lid Stay



Delta Flip Up Lid Stay  
Reversible.  
Packed individually.  
Part Number: FRLE1GCOOK276

## Electric Flat Screen TV Lift

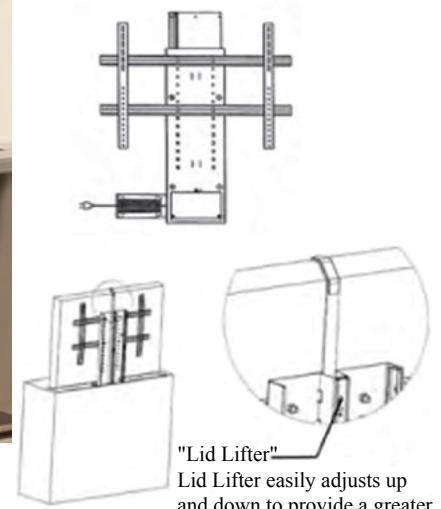

"Lid Lifter"  
Lid Lifter easily adjusts up and down to provide a greater degree of flexibility when raising the TV out of the cabinet.

High quality German Bosch motor for whisper quiet operation. Ball bearing guide system for added stability. Requires only 2 3/4" of depth behind the TV. Can be easily mounted by one person in just minutes using only one screwdriver. Radio command remote control operation with manual over-ride switch.

Part Number	Description	Total Travel	Weight Capacity	For TV's
FU7032312037	Whisper 700	27 3/16"	220 lbs	26" - 42"
FU4050845606	Whisper 750	29 1/2"	200 lbs	37" - 48"
FU7032312035	Whisper 1000	39 3/8"	225 lbs	50" - 65"

## Versalift



The remote control lift designed for multiple applications. Rack & pinion design with unique patent pending stability system. Perfect for raising and lowering TV's up to 26", computer monitors etc. Can be used to lower monitors from upper cabinets. 110 lb weight capacity 18" (457mm) of travel. Versalift includes remote control, manual override switch, and cUL listed power supply.

Versalift Part Number: FU4055645945

Versalift with Bracket Part Number: FU4056645945

## Euro Style Drawer Slides

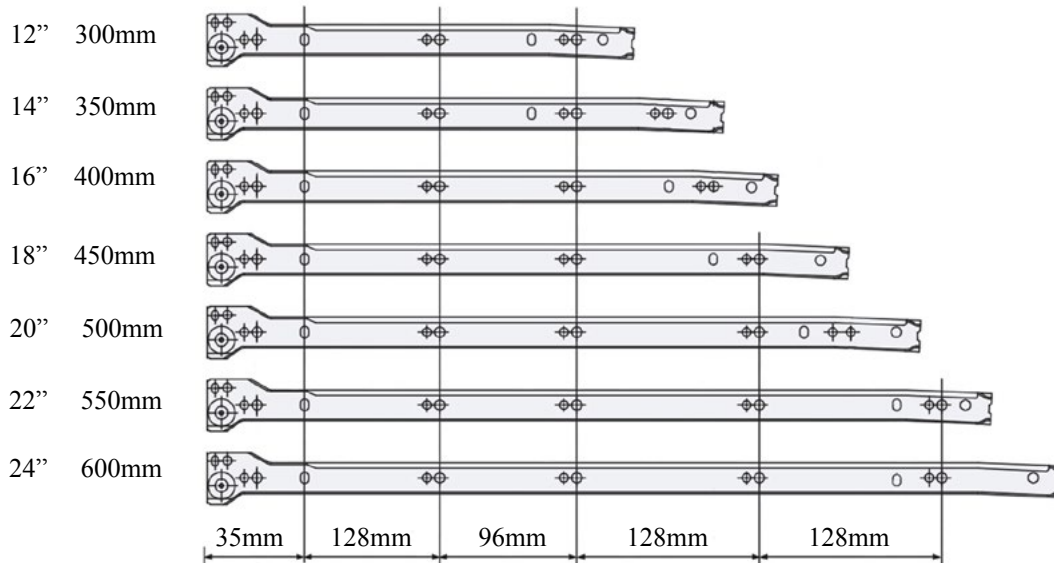

Slides

### Self Closing Import Slides



Load Rating: 75 lbs /pair

Size	White	Brown	Black Stay Close	Box Quantity
12" - 300mm	7111KSC12W			20 sets
14" - 350mm	7111KSC14W	7111KSC14B	7110214IXF	20 sets
16" - 400mm	7111KSC16W		7110216IX	20 sets
18" - 450mm	7111KSC18W		7110218IX	20 sets
20" - 500mm	7111KSC20W			20 sets
22" - 550mm	7111KSC22W	7111KSC22BF		20 sets
24" - 600mm	7111KSC24W			20 sets

### Euro Drawer Slides - Salice



Size	Part Number	Load Rating lbs/pr	Color	Sets Per Box
14"	65A208351CP25	75	White	100
16"	65A208401CP25	75	White	100
18"	65A208451	75	White	100
20"	65A208501	75	White	100
22"	65A208551	75	White	100

### Rear Sockets



Part Number	Type
711222EUSKT1R	Fixed Rear Right Socket
711222EUSKT1L	Fixed Rear Left Socket



### Recommended Screws for Drawer Slides



Available in Zinc and Black Oxide.

Size	Thread Type	Part Number	Carton Quantity
6 x 1/2	Coarse Thread	01610608xx	30,000
6 x 5/8	Coarse Thread	01610610xxS	25,000
6 x 3/4	Coarse Thread	01610612xx	20,000

## Harn Premium Import Slides



Load Rating: 100 lbs /pair

### Slides

Size	Part Number	Color	Box Quantity
12" - 300mm	FGV5408201300	White	25 sets
14" - 350mm	FGV5408201350	White	25 sets
16" - 400mm	FGV5408201400	White	25 sets
18" - 450mm	FGV5408201450	White	25 sets
20" - 500mm	FGV5408201500	White	25 sets
22" - 550mm	FGV5408201550	White	25 sets
24" - 600mm	FGV5408201600	White	25 sets

## Drawer Slide Accessories



### Drawer Glide

1 1/8 inch x 1 1/8 inch x 1/2 inch 1/8 inch thick. Staple tabs are 5/16 inch long and .050 inch thick.

Part Number: 711214



### L Clip Tack Glide

1/2 inch x 3/4 inch x 1/2 inch

Part Number: 711213

## Back Slide For Wooden Slides



### Backslide

1 3/16 inch x 5/16 inch slide holding area.

Part Number: 711202509



## Titusoft Wood Drawer Soft Close



- \*Easy intuitive mounting.
- \*Universal application, will fit most standard drawers.
- \*Smooth soft closing action independent of drawer hardware.
- \*Non-handed design.

### Titusoft Wood Drawer Soft Close Mechanism

Grey

Packed 250 per Box

Part Number: 679730M99



### Titusoft Wood Drawer Activator

Grey

Packed 250 per Box

Part Number: 67973445138001

## Stand Off

Stand off for drawer alignment correction.



3602



3608

Size	Part Number	Color	Box Quantity
1/2"	71443600	White	1,000
3/4"	71443601	White	2,500
3/4"	71443601BK	Black	2,500
13/16"	71443628W	White	2,500
1"	71443602	White	2,500
1"	71443602BK	Black	2,000
1 1/2"	71443608AL	Almond	1,000
1 1/2"	71443608	White	1,000
1 3/4"	71443631BK	Black	1,000
1 7/8"	71443630BK	Black	500



## Side Spacers



3618



3625



3617

Size	Part Number	Color	Outer Diameter	Stackable	Box Quantity
1/8"	71443618	Natural	3/4"	No	2,500
7mm	71443650BK	Black	7/8"	Yes	5,000
3/8"	71443625	Natural	1"	Yes	5,000
1/2"	71443617BK	Black	5/8"	No	7,500

## Step Spacer



Step Spacer Black  
Used for squaring cabinets.  
Packed 1,000 per Box

Part Number: 71443619BK

## Undermount Spacer

Undermount Drawer Slide Spacer  
Install using Euro Screws



Size	Part Number	Color	Box Quantity
1"	71443640W	White	500
1 1/4"	71443633W	White	500
1 3/4"	71443639	Natural	500

\*Available in 5/8", 1", 1 1/4", 1 1/2" and 1 3/4" sizes.

\*Available in Almond, Black, Brown, Silver, Tan and White.

## Undermount Rear Socket



Undermount Socket with Dowels  
Natural.  
Packed 500 per Box

Part Number: 71126831



## QuikTRAY™ Supports



1"



1 1/4"

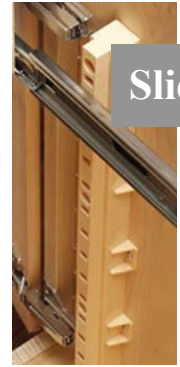

2"

Slides

QuikTRAY™ install easily and adjusts without tools, useful with frame or frameless cabinets. With QuikTRAY™ there's no need to change your current specifications in order to maximize storage space in new or existing cabinets. The versatility and simplicity of the system works with any standard cabinet and most brands of drawer slides.

Set Includes:

- 4 - QuikTRAY™ Supports
- 8 - T-506 Hook Dowels for Machine Screw
- 8 - HAR-031 6-32x3/8 Machine Screw
- 20 - HAR-020 #6x7/16" Pan Head Phillips Zinc Screw
- 1 - INS-015 Instruction Sheet

Part Number	Size	Color	Box Quantity
TNB52000	1" x 20"	White	20 sets
TNB52001	1" x 20"	Beige	20 sets
TNB52200	1 1/4" x 20"	White	20 sets
TNB52201	1 1/4" x 20"	Beige	20 sets
TNB52500	2" x 20"	White	10 sets
TNB52501	2" x 20"	Beige	10 sets

## Short QuikTRAY™ 1 1/4" Support



Set Includes:

- 4 - QuikTRAY™ Supports
- 4 - T-506 Hook Dowels for Machine Screw
- 4 - HAR-031 6-32x3/8 Machine Screw

Part Number	Size	Color	Box Quantity
TNB52300	1 1/4" x 3 3/4"	White	20 sets
TNB52301	1 1/4" x 3 3/4"	Beige	20 sets

Center Partition Support for 3" Center Stile

Slides



Set Includes:  
2 - QuikTRAY™ Center Partition Supports  
1 - B231 (20 x HAR-020 Mounting Screws)

Part Number	Type	Length	Color	Box Quantity
TNB23500	Center Partition	20"	White	12 sets
TNB23501	Center Partition	20"	Beige	12 sets

Rollout Tray Bumper



Screw on or staple.  
Truss head screw is recommended.

Part Number	Size	Color	Box Quantity
TNT16100	11.5 mm	Natural	2,000
TNT16102	11.5 mm	Beige	2,000

Hook Dowels



T-506



T-507



T-508

Part Number	For	Box Quantity
TNT506	Side Mount Slides	1,000
TNT507	Side Mount Slides with 1/4" Spacer	1,000
TNT508	Undermount Slides	1,000

Hook Dowel Screws



6-32 x 3/8 Phillips Flat Machine Screws for QuikTRAY™ Hook Dowels.  
Packed 2,000 per box

Part Number: TNHAR031

Impaz Drawer System

“Impaz” is the complete solution for all your cabinet drawer needs.

“Impaz” offers unique features:

- |                                     |                                  |
|-------------------------------------|----------------------------------|
| Three heights (3.3", 4.6", 5.8")    | Rail system                      |
| Steel drawer side panels            | Single extension                 |
| Self closing                        | Load capacity 25 kg/55 lbs       |
| Epoxy coated                        | Smooth rolling mechanism         |
| Two way front adjustments           | Double out-stop safety feature   |
| Clip-on front brackets              | Locked-in position when extended |
| RTA assembly (no machines required) |                                  |

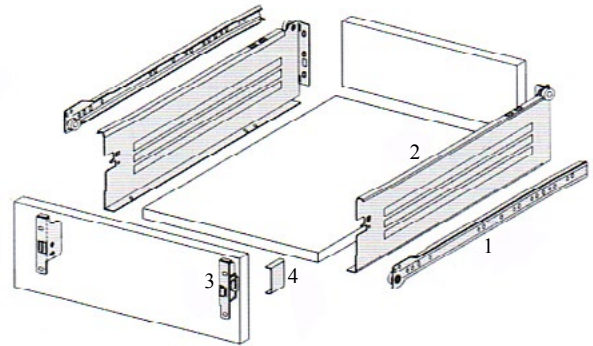

1. Cabinet members left & right.
2. Drawer sides left & right.
3. Front fixing brackets. (Sold Separately)
4. Cover caps. (Sold Separately)

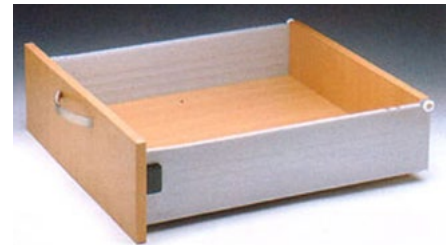

Part Number	Length	Height	Color	Box Quantity
FU4021400	400mm 16"	3.3"	White	10
FU4021450	450mm 18"	3.3"	White	10
FU4021500	500mm 20"	3.3"	White	10
FU4021550	550mm 22"	3.3"	White	10
FU4321400	400mm 16"	4.6"	White	5
FU4321450	450mm 18"	4.6"	White	5
FU4321500	500mm 20"	4.6"	White	5
FU4321550	550mm 22"	4.6"	White	5
FU4621400	400mm 16"	5.8"	White	5
FU4621450	450mm 18"	5.8"	White	5
FU4621500	500mm 20"	5.8"	White	5
FU4621550	550mm 22"	5.8"	White	5



## Impaz Drawer System

### Front Fixing Bracket - Clip-On

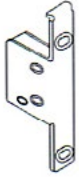

Type	Right	Left
Screw - On	FU16040R	FU16040L

### Drawer Front Marking Jigs



For 4021, 4321, 4621  
Part Number: FU91040

### Railing Marking Template



For marking single and double railing.  
Part Number: FU92404

Drilling Template is available  
Part Number: FU93000



The star in your cabinet

## Vionaro



### Features

- \*90° straight corners and sides.
- \*Slim 13mm width Side
- \*Integrated height and side adjustment, tilt adjustment at back.
- \*Tool-free assembly.
- \*Works exclusively with Dynapro.
- \*Maximum drawer width 48".
- \*For frame and frameless cabinetry.
- \*Stocking in 15" (381mm), 18" (457mm) and 21" (533mm) lengths.
- \*Stocking in 3 1/2" (89 mm), 4 3/4" (121 mm), 7 1/4" (185mm) and 9 3/4" (249mm) heights.

Slides

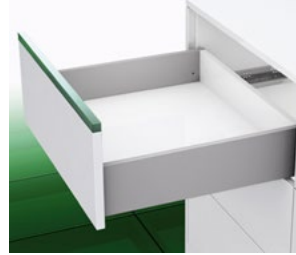

### H89

Part Number	Description	Finish	Box Quantity
GRF135121353211	89mm x 381mm (15") Vionaro	Graphite	10 pair
GRF135121356211	89mm x 457mm (18") Vionaro	Graphite	10 pair
GRF135121359211	89mm x 533mm (21") Vionaro	Graphite	10 pair

### H121

Part Number	Description	Finish	Box Quantity
GRF135135059207	121mm x 381mm (15") Vionaro	Graphite	10 pair
GRF135135062207	121mm x 457mm (18") Vionaro	Graphite	10 pair
GRF135135065207	121mm x 533mm (21") Vionaro	Graphite	10 pair

### H185

Part Number	Description	Finish	Box Quantity
GRF135121553207	185mm x 381mm (15") Vionaro	Graphite	10 pair
GRF135121556207	185mm x 457mm (18") Vionaro	Graphite	10 pair
GRF135121559207	185mm x 533mm (21") Vionaro	Graphite	10 pair

### H249

Part Number	Description	Finish	Box Quantity
GRF135135086207	249mm x 381mm (15") Vionaro	Graphite	10 pair
GRF135135089207	249mm x 457mm (18") Vionaro	Graphite	10 pair
GRF135135092207	249mm x 533mm (21") Vionaro	Graphite	10 pair

Vionaro

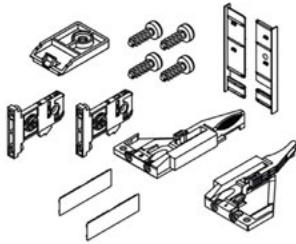

Insert Drawer Accessory Set for H89

Set Includes:

- 2 cover caps
- 1 front locking device set left/right
- 2 front connectors
- 4 front connector screws
- 1 front bottom connector
- 2 end cap

Insert Drawer Accessory Set for H89

Graphite

Packed 50 per box

Part Number: GRF136100278517

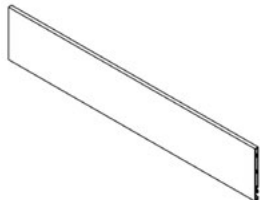

H89 Insert Front Panel

Graphite

Packed 10 per box

Part Number: GRF136120538507

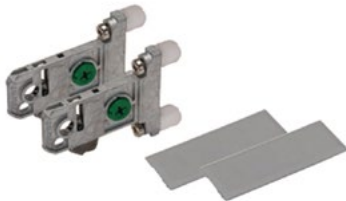

Adapter Set for H89 or H121

Set includes:

- 2 front connectors with 10mm dowels
- 2 interior cover caps.

Packed per box

Gray Part Number: GRF136106491517

Graphite Part Number: GRF136106492517

Vionaro

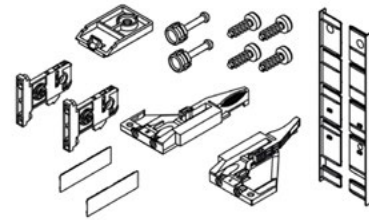

Insert Drawer Accessory Set for H185

Set Includes:

- 2 cover caps
- 1 front locking device set left/right
- 2 front connectors
- 4 front connector screws
- 1 front bottom connector
- 2 end cap

Insert Drawer Accessory Set for H185

Graphite

Packed 50 per box

Part Number: GRF136100319517

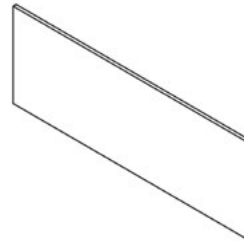

H185 Insert Front Panel

Graphite

Packed 10 per box

Part Number: GRF136120539507

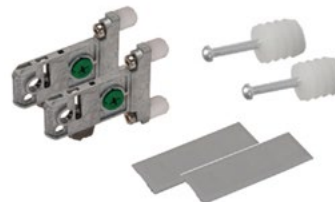

Adapter Set for H185

Set includes

- 2 front connectors with 10mm dowels
- 2 interior cover caps
- 2 front stabilizers with 8mm dowels.

Packed per box

Gray Part Number:

GRF136106493517

Graphite Part Number:

GRF136106494517



## ZBox - Drawer Slide



- \*Integrated side mount ball bearing drawer slide and metal drawer side.
- \*Ball bearing telescopic full extension.
- \*Hold-in detent ensures drawer stay closed.
- \*Easy lever disconnect for removal of drawer box from cabinet member.
- \*Drawer side - white epoxy finish; Drawer slide - zinc coated steel.
- \*Load capacity: 100 lb dynamic, 100 lb static.
- \*Adjustments: Cam Height +/-2mm, Side +/-1.5mm.

### ZBox 6023

Part Number	Description	Drawer Slide Side Height	Color	Box Quantity
GR3006303	350mm/ 13 3/4" ZBox Slide	3 3/8"	White	5 sets
GR3006403	400mm/ 15 3/4" ZBox Slide	3 3/8"	White	5 sets
GR3006503	470mm/ 18 1/2" ZBox Slide	3 3/8"	White	5 sets
GR3006703	550mm/ 21 5/8" ZBox Slide	3 3/8"	White	5 sets

### ZBox 6223

Part Number	Description	Drawer Slide Side Height	Color	Box Quantity
GR3007303	350mm/ 13 3/4" ZBox Slide	5 7/8"	White	5 sets
GR3007403	400mm/ 15 3/4" ZBox Slide	5 7/8"	White	5 sets
GR3007503	470mm/ 18 1/2" ZBox Slide	5 7/8"	White	5 sets
GR3007703	550mm/ 21 5/8" ZBox Slide	5 7/8"	White	5 sets

### ZBox 6423

Part Number	Description	Drawer Slide Side Height	Color	Box Quantity
GR3007803	350mm/ 13 3/4" ZBox Slide	8 3/8"	White	5 sets
GR3007903	400mm/ 15 3/4" ZBox Slide	8 3/8"	White	5 sets
GR3008003	470mm/ 18 1/2" ZBox Slide	8 3/8"	White	5 sets
GR3008303	550mm/ 21 5/8" ZBox Slide	8 3/8"	White	5 sets

## Zargen - Drawer Slide



- 100 pound Unigrass
- D1 for Automatic Installation
- Integrated drawer slide and side panel.
- Self-closing feature with 60mm (2 5/8") self-closing range.
- Includes built-in drawer front adjustment and bumpers.
- Doweled for rapid assembly.
- Adapts to frame or frameless construction.
- Available in white baked-on epoxy finish.

### Zargen 6036

Part Number	Description	Drawer Slide Side Height	Color	Box Quantity
GR1189504	270mm/ 10 5/8" Zargen Slide	3 3/8"	White	5 sets
GR1189604	350mm/ 13 3/4" Zargen Slide	3 3/8"	White	5 sets
GR1284904	400mm/ 15 3/4" Zargen Slide	3 3/8"	White	5 sets
GR1285004	440mm/ 17 3/8" Zargen Slide	3 3/8"	White	5 sets
GR1285104	470mm/ 18 1/2" Zargen Slide	3 3/8"	White	5 sets
GR1285204	510mm/ 20 1/16" Zargen Slide	3 3/8"	White	5 sets
GR1190104	550mm/ 21 5/8" Zargen Slide	3 3/8"	White	5 sets

### Zargen 6136

Part Number	Description	Drawer Slide Side Height	Color	Box Quantity
GR2290603	350mm/ 13 3/4" Zargen Slide	4 5/8"	White	5 sets
GR2290703	400mm/ 15 3/4" Zargen Slide	4 5/8"	White	5 sets
GR2270003	440mm/ 17 3/8" Zargen Slide	4 5/8"	White	5 sets
GR2270103	470mm/ 18 1/2" Zargen Slide	4 5/8"	White	5 sets
GR2270203	510mm/ 20 1/16" Zargen Slide	4 5/8"	White	5 sets
GR2270303	550mm/ 21 5/8" Zargen Slide	4 5/8"	White	5 sets



## Zargen - Drawer Slide

### Zargen 6236

#### Slides

Part Number	Description	Drawer Slide Side Height	Color	Box Quantity
GR2290803	350mm/ 13 3/4" Zargen Slide	5 7/8"	White	5 sets
GR2290903	400mm/ 15 3/4" Zargen Slide	5 7/8"	White	5 sets
GR2270403	440mm/ 17 3/8" Zargen Slide	5 7/8"	White	5 sets
GR2270503	470mm/ 18 1/2" Zargen Slide	5 7/8"	White	5 sets
GR2270603	510mm/ 20 1/16" Zargen Slide	5 7/8"	White	5 sets
GR2270703	550mm/ 21 5/8" Zargen Slide	5 7/8"	White	5 sets

### Zargen 6436

Part Number	Description	Drawer Slide Side Height	Color	Box Quantity
GR2291003	350mm/ 13 3/4" Zargen Slide	8 3/8"	White	5 sets
GR2291103	400mm/ 15 3/4" Zargen Slide	8 3/8"	White	5 sets
GR2270803	440mm/ 17 3/8" Zargen Slide	8 3/8"	White	5 sets
GR2270903	470mm/ 18 1/2" Zargen Slide	8 3/8"	White	5 sets
GR2271003	510mm/ 20 1/16" Zargen Slide	8 3/8"	White	5 sets
GR2271103	550mm/ 21 5/8" Zargen Slide	8 3/8"	White	5 sets

## Dynapro 2.0 Soft Close Drawer Slides



- \* Ridges on drawer member and front locking devices for immediate connection
- \* Support roller for uniform drawer front height
- \* Easy to open with a low pull-out force of 20 N (4.4 lbs)
- \* Wear resistant nylon rollers ensure quiet and precise running characteristics
- \* Minimal drawer front gap using the integrated 2-D adjustment
- \* Superior stability provided by 31mm wide drawer members
- \* Face frame or frameless application
- \* Full extension with a synchronized mechanism
- \* Soft-close damping system
- \* Maximum connection to drawer slide and front locking device
- \* Uniform height position of drawer front panel, regardless of weight
- \* Suitable for drawers up to 48" wide
- \* Simple adjustment, tool-free and easily accessible
- \* Integrated 2-dimensional adjustment for alignment
- \* Height adjustment + 3.5mm
- \* Side adjustment +/- 1.5mm
- \* 88 lbs load rating (40 kg)
- \* For 5/8" (16mm) drawer material

Part Number	Drawer Length	Box Quantity
GR1310003	9"	5 pair
GR1310103	12"	5 pair
GR1310203	15"	5 pair
GR1310303	18"	5 pair
GR1310403	21"	5 pair

## Dynapro Front Locking Device

- \*For 2-dimensional drawers
- \*For standard width drawers
- \*For standard width inset drawers
- \*Minimum inside drawer width 180mm (7 3/32")
- Pre-drilling recommended 2.5mm (3/32")



Packed 200 per Box  
Left Part Number: GRF134125000233  
Right Part Number: GRF134125001233



### 3 Dimensional-Dynapro Soft Close Drawer Slides

- \* Frameless or face frame application for 5/8" (16 mm) drawer material.
  - \* Full extension with a synchronized mechanism.
  - \* Soft-close damping system.
  - \* Maximum connection drawer slide and front locking device.
  - \* Integrated 3-dimensional adjustment for alignment.
  - \* Height adjustment + 3.5 mm
  - \* Side adjustment +/- 1.5 mm
  - \* Tilt adjustment + 4.0 mm
  - \* 88 lbs load rating (40 kg)
- Requires Dynapro Adjustment Adapter

Part Number	Drawer Length	Box Quantity
GRF130100726204	12"	5 pair
GRF130100727204	15"	5 pair
GRF130100728204	18"	5 pair
GRF130100729204	21"	5 pair

### Heavy Duty - Dynapro Soft Close Drawer Slides

Same features as above except;  
132 lbs load rating (60 kg)  
3.-Dimensional adjustment  
Requires Dynapro Adjustment Adapter

Part Number	Drawer Length	Box Quantity
GRF130100730204	18"	5 pair
GRF130100731204	21"	5 pair
GRF130100732204	24"	5 pair
GRF130101394203	27"	5 pair
GRF130101395203	30"	5 pair

### Dynapro Adjustment Adapters



- \*For 3-dimensional drawers
- Packed 200 per Box  
Left Part Number: GRF134125002233  
Right Part Number: GRF134125003233

### 3D Dynapro Front Locking Device



- \*For 3-dimensional drawers
  - \*For standard width drawers
  - \*For standard width inset drawers
  - \*Minimum inside drawer width 150mm (5 7/8")
  - \*For drawer materials 1/2" (13mm) up to 3/4"(19mm)
  - \*For frameless or face frame application
- Packed 200 per Box  
Left Part Number: GRF134108947233  
Right Part Number: GRF134108948233

**Slides**

### Dynapro Narrow Front Locking Device



- \*For 1-dimensional and 2-dimensional drawers
  - \*For narrow and standard width drawers
  - \*For narrow and standard width inset drawers
  - \*Minimum inside drawer width 95mm (3 3/4")
  - Pre-drilling recommended 2.5mm (3/32")
- Packed 200 per Box  
Left Part Number: GRF134100699233  
Right Part Number: GRF134100700233

### Dynapro Rear Mount Sockets



Packed 150 pair per box.  
Part Number: GR7950VE300

### Dynapro Drilling Template



Part Number: GRF146109874299

**Salice F70 Heavy Duty Smove Slides**

Full extension heavy duty fully synchronized drawer runner.

Face frame assembly with metal socket.

Smove: Fully integrated in the runner, decelerates the closing action of the drawer.

Slides



- \* 154 dynamic load capacity.
- \* With Smove decelerated system.
- \* Safety system that prevents the drawers from turning over.
- \* Drawer height adjustment (+ 3mm).
- \* Available in 15" to 30" length.
- \* Compatible with Lineabox drawers.
- \* Finish: bright zinc-plated.
- \* 100% made in Italy.

Part Number	Size	Side	Box Quantity
65G7U6S457XXD	18"	Right Hand	6 pair
65G7U6S457XXS	18"	Left Hand	6 pair
65G7U6S533XXD	21"	Right Hand	6 pair
65G7U6S533XXS	21"	Left Hand	6 pair
65G7U6S610CXD	24"	Right Hand	6 pair
65G7U6S610CXS	24"	Left Hand	6 pair
65G7U6S686CXD	27"	Right Hand	4 pair
65G7U6S686CXS	27"	Left Hand	4 pair
65G7U6S762CXD	30"	Right Hand	4 pair
65G7U6S762CXS	30"	Left Hand	4 pair

**Salice F70 Heavy Duty Smove Slides**

**F70 Front Locking Device**



Front locking device.

Standard mount - side and depth adjustments.

Dual metal/plastic construction.

Tool free lateral and depth adjustments.

Pre-drilling recommended 2.5mm (3/32")

Right hand and left hand clips

100 per box.

Right Locking Device Part Number: 65AFCGXX3D

Left Locking Device Part Number: 65AFCGXX3S

**F70 Tilt Adjustment Lever**



Tilt adjustment lever.

Provides +3mm of adjustment to help align drawers.

Works without drawer removal.

100 per box

Part Number: 65AGLRXX3F



**Salice Futura Smove Slides**

**Futura Smove 7555 Undermount Slide**

Full extension runner fixed to the drawer front by clip.

Smove: Fully integrated in the runner, decelerates the closing action of the drawer.

Product Features: ANSI - Grade 1

- \* Dynamic load capacity N 294 (75 lbs)/100 lbs static.
- \* With Smove decelerated system.
- \* Safety system that prevents the drawers from turning over.
- \* Drawer height adjustment (+ 3mm).
- \* Finish: bright zinc-plated.



Part Number	Size	Runner Length	Box Quantity
65A7555229	9"	239mm / 9.4"	6 pair
65A7555305	12"	315mm / 12.4"	6 pair
65A7555381	15"	391mm / 15.4"	6 pair
65A7555457	18"	467mm / 18.4"	6 pair
65A7555533	21"	543mm / 21.4"	6 pair

**Futura Smove 7557 Undermount Push Slide**

Product Features: ANSI - Grade 1

- \* Load capacity: 75 lbs dynamic 100 lbs static.
- \* With Push Opening System.
- \* Safety system that prevents the drawers from turning over.
- \* Drawer height adjustment (+ 3mm).
- \* Finish: bright zinc-plated.



Part Number	Size	Runner Length	Box Quantity
65A7557229	9"	263mm / 10.4"	6 pair
65A7557305	12"	315mm / 12.4"	6 pair
65A7557381	15"	391mm / 15.4"	6 pair
65A7557457	18"	467mm / 18.4"	6 pair
65A7557533	21"	543mm / 21.4"	6 pair

**Salice Futura Smove Slides**

**Futura Smove Adjustable Clips**



Clips sold separately.

Right hand and left hand clips

100 per box.

Right Clip Part Number: 65A750010R

Left Clip Part Number: 65A750010L

**Futura Smove Front Clips**



Front Clips sold separately.

Right hand and left hand clips

100 per box.

Right Clip Part Number: 65A710610R

Left Clip Part Number: 65A710610L

**Futura Smove Rear Bracket**



Rear Bracket

100 per box

Part Number: 65AGSKXX5

**Futura Undermount Jig**



Futura Undermount Jig

Part Number: 65A199800755010

Slides

## Under-mount Soft Close Slides with 3D Locking Device

### Slides



Included 3D Locking Device

Features: Full extension under mounted slides.  
3 way adjustable.  
Lever disconnect.  
Loading capacity 90 lbs

Part Number	Slide Length Inches	Finish	Box Quantity
PR88009	9"	Zinc	6 sets
PR850012	12"	Zinc	6 sets
PR850015	15"	Zinc	6 sets
PR850018	18"	Zinc	6 sets
PR850021	21"	Zinc	6 sets



Rear bracket for 8500 slide.  
Packed 100 per box.

Part Number: PR8500BRKT

## Advantage Pro 7800 Series

### Soft-Close Undermount Slides



Features: \* 7/8 extension undermount slides with soft close.  
\* Designed for American 3" increment drawer depth system.  
\* Available with rear metal bracket.  
\* 75 lbs capacity, 50,000 cycles per KCMA requirements.

Part Number	Drawer Length	Finish	Box Quantity
PR780012	12"	Zinc	6 pairs
PR780015	15"	Zinc	6 pairs
PR780018	18"	Zinc	6 pairs
PR780021	21"	Zinc	6 pairs

### Soft-Close Undermount Clips and Brackets

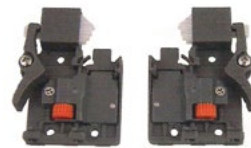

Included Clips



Included Rear Brackets

### Soft-Close Undermount Side Bracket



Side Bracket  
Sold separately.  
Packed 100 per Box  
Part Number: PR7800EUBRKT



## Touch to Open Full Extension Slides - Repon



Features: Unhanded trigger release.  
1/2" side spacing.  
Load rating 100 lbs based on 18" slides.



Part Number	Slide Length Inches	Slide Travel Inches	Finish	Slides Per Box
FU1202012	12"	8 1/2"	Zinc	20 pair
FU1202014	14"	11 3/8"	Zinc	20 pair
FU1202016	16"	14 3/8"	Zinc	20 pair
FU1202018	18"	17 5/16"	Zinc	10 pair
FU1202020	20"	19 11/16"	Zinc	10 pair
FU1202022	22"	21 11/16"	Zinc	10 pair
FU1202024	24"	23 5/8"	Zinc	10 pair
FU1202026	26"	25 9/16"	Zinc	10 pair
FU1202028	28"	27 9/16"	Zinc	10 pair

Use Rear Bracket PR46BRACKET

## Soft Closing Full Extension Slides - Repon



Features: Unhanded trigger release.  
1/2" side spacing.  
Load rating 100 lbs based on 18" slides.



Part Number	Slide Length Inches	Slide Travel Inches	Finish	Slides per Box
FU1201012	12"	8 1/2"	Zinc	20 pair
FU1201014	14"	11 3/8"	Zinc	20 pair
FU1201016	16"	14 3/8"	Zinc	20 pair
FU1201018	18"	17 5/16"	Zinc	10 pair
FU1201020	20"	19 11/16"	Zinc	10 pair
FU1201022	22"	21 11/16"	Zinc	10 pair
FU1201024	24"	23 5/8"	Zinc	10 pair
FU1201026	26"	25 9/16"	Zinc	10 pair
FU1201028	28"	27 9/16"	Zinc	10 pair

## Soft Closing Full Extension Economy Slides



Features: Side mounted.  
Full extension.  
Unhanded trigger release.  
1/2" side spacing.  
Load rating 100 lbs based on 18" slides.

Slides

Part Number	Slide Length Inches	Slide Travel Inches	Finish	Slides Per Box
PR490314	14"	15.394"	Zinc	10 pair
PR490316	16"	17.362"	Zinc	10 pair
PR490318	18"	19.37"	Zinc	10 pair
PR490320	20"	21.378"	Zinc	10 pair
PR490322	22"	23.386"	Zinc	10 pair



Rear adjustable socket for 4903 slide.  
Screw on.  
Packed 100 per box.

Part Number: PR4903BRKTSO

## Drawer Slide Screw

Stocked in Steel Zinc Plating.



Size	Thread Type	Part Number	Weight Pounds/M	Carton Quantity
8 x 7/16	Coarse	01660807xx	4.20	20,000
8 x 1/2	Coarse	01660808xx	4.20	14,000

# DYNASLIDE®

## Ball Bearing Full Extension Non Progressive Slides



### Slides

- Features: Unhanded butterfly release.  
 Hold-in detent.  
 1/2" side spacing.  
 1" over-travel.  
 Front mounting hole for face frame applications.

Part Number	Slide Length Inches	Slide Travel Inches	Load Rating lbs/pr	Finish	Box Quantity
DS463410	9 21/32"	10"	120	Zinc	20 pair
DS463412	11 13/16"	12"	115	Zinc	20 pair
DS4634BR14	13 25/32"	14"	110	Zinc	20 pair
DS4634BR16	15 3/4"	16"	105	Zinc	20 pair
DS4634BR18	17 23/32"	18"	100	Zinc	10 pair
DS4634BR20	19 11/16"	20"	95	Zinc	10 pair
DS4634BR22	21 21/32"	22"	90	Zinc	10 pair
DS4634BR24	23 5/8"	24"	85	Zinc	10 pair
DS4634BR26	25 19/32"	26"	80	Zinc	10 pair
DS4634BR28	27 9/16"	28"	75	Zinc	10 pair

\*Some sizes of slides are available in Stainless Steel.  
 Please contact U.S. Industrial for more information.

### Pull Out Mounting Bracket



2 1/2" Slide Mounting Bracket  
 Uses 4mm machine screws to mount slide.  
 Packed 200 per Box.  
 Part Number: 7101BMB

Kit Part Number: 7109UBMB  
 (Kit includes 4 - 7101BMB brackets and 8 - 4mm x 8mm Phillips Flat Machine Screws)

### Rear Mounting Bracket For Face Frames



Metal type.  
 Part Number:  
 DS46BRACKET



Adjustable Plastic type.  
 Part Number: 71126743

## Full Extension - Economy Slide - Fulterer



- Features: Unhanded trigger release.  
 Hold-in detent.  
 1/2" side spacing.  
 1" over-travel.  
 32mm screw mount system compatible.  
 Face frame hole.  
 Load rating 100 lbs based on 18" slides.

Part Number	Slide Length Inches	Slide Travel Inches	Finish	Slides Per Box
KV8400B8	8"	8"	Zinc	10 pair
FL5045250	10"	11"	Zinc	15 pair
FL5045300	12"	13"	Zinc	15 pair
FL5045350	14"	15"	Zinc	15 pair
FL5045400	16"	17"	Zinc	15 pair
FL5045450	18"	19"	Zinc	15 pair
FL5045500	20"	21"	Zinc	15 pair
FL5045550	22"	23"	Zinc	15 pair
FL5045600	24"	25"	Zinc	15 pair
FL5045650	26"	27"	Zinc	15 pair
FL5045700	28"	29"	Zinc	15 pair

Use Bracket FL5045BRKT

## Full Extension Progressive



- Features: Rail mounting.  
 1/2" side spacing.  
 Detent-in closed position.  
 Hold-in detent.  
 With over-travel.  
 Load rating 150 lbs based on 18" slides.

Part Number	Slide Length Inches	Slide Travel Inches	Finish	Slides Per Box
PR500012	12"	13.386"	Zinc	10 pair
PR500014	14"	15.394"	Zinc	10 pair
PR500016	16"	17.362"	Zinc	10 pair
PR500018	18"	19.37"	Zinc	10 pair
PR500020	20"	21.378"	Zinc	10 pair
PR500022	22"	23.386"	Zinc	10 pair
PR500024	24"	25.394"	Zinc	10 pair
PR500026	26"	27.362"	Zinc	10 pair
PR500028	28"	29.37"	Zinc	10 pair



## Square Profile Economy Slides



- Features: Unhanded trigger release.  
 Hold-in detent.  
 1/2" side spacing.  
 1" over-travel.  
 32mm screw mount system compatible.  
 Face frame hole.  
 Load rating 100 lbs based on 18" slides.

Part Number	Slide Length Inches	Slide Travel Inches	Finish	Slides Per Box
PR460012BK	12"	13"	Black	10 pair
US14FEOTZ	14"	15"	Zinc	10 pair
PR460014BK	14"	15"	Black	10 pair
US16FEOTZ	16"	17"	Zinc	10 pair
PR460016BK	16"	17"	Black	10 pair
US18FEOTZ	18"	19"	Zinc	10 pair
PR460018BK	18"	19"	Black	10 pair
US20FEOTZ	20"	21"	Zinc	10 pair
PR460020BK	20"	21"	Black	10 pair
US22FEOTZ	22"	23"	Zinc	10 pair
PR460022BK	22"	23"	Black	10 pair

Use Bracket PR46BRACKET

## Low Profile Full Extension Slides



- Features: 1/2" side clearance.  
 Side mounted.  
 Lever disconnect.  
 Detent-in closed position.  
 36mm height  
 Trigger release disconnect.  
 Load rating 85 lbs based on 18" slides

Part Number	Slide Length Inches	Finish	Slides per Box
PR350012	12"	Zinc	10 pair
PR350014	14"	Zinc	10 pair
PR350016	16"	Zinc	10 pair
PR360116BK	16"	Black	10 pair
PR350018	18"	Zinc	10 pair
PR350020	20"	Zinc	10 pair
PR350022	22"	Zinc	10 pair

Use Rear Bracket PR46BRACKET

## Heavy Duty Full Extension Slides



- Features: 3/4" side spacing.  
 Two stage detent function.  
 Positive detent in.  
 Detachable.  
 Non-handed.  
 With 1" over-travel.  
 Load rating 250 lbs based on 18" slides.

Applications: Heavy lateral filing cabinets, large storage drawers, and electronic racks.

Slides

Part Number	Slide Length Inches	Slide Travel Inches	Finish	Slides per Box
PR589010	10"	11"	Zinc	10 pair
PR589012	12"	13"	Zinc	10 pair
PR589014	14"	15"	Zinc	10 pair
PR589016	16"	17"	Zinc	10 pair
PR589018	18"	19"	Zinc	10 pair
PR589020	20"	21"	Zinc	10 pair
PR589022	22"	23"	Zinc	10 pair
PR589024	24"	25"	Zinc	10 pair
PR589026	26"	27"	Zinc	10 pair
PR589028	28"	29"	Zinc	10 pair
PR589030	30"	31"	Zinc	10 pair
PR589032	32"	33"	Zinc	10 pair
PR589034	34"	35"	Zinc	10 pair
PR589036	36"	37"	Zinc	10 pair

## Heavy Duty Full Extension Vertical Pantry Pull-Out Slide System -Fulterer



**Fulterer**

Part Number	Type	Slide Length MM	Slide Travel MM	Finish	Slides per Box
FL83573	FR 771A with Easy Close Device	575mm	559mm	White	1 set



**Fulterer**

Part Number	Type	Slide Length MM	Slide Travel MM	Finish	Slides per Box
FL7703	FR 777A	550mm	534mm	White	1 set

Easy Close Device  
 Part Number: FL7719



## Heavy Duty Full Extension Slides - Repon



- Slides**
- REPON**
- Features: 1/2" side spacing.
  - Trigger release disconnect.
  - Breather tab self adjustment to accommodate variation in side clearance.
  - Anti-rebound.
  - Non-handed.
  - Detent-in closed position.
  - Easy access window to reach hole in cabinet member in closed position.
  - Load rating 200 lbs based on 18" slides.

Applications: Commercial furniture, mechanical equipment, electronic enclosures, file drawers, and kitchens

Part Number	Slide Length Inches	Finish	Slides per Box
FUNJ81A0214	14"	Zinc	10 pair
FUNJ81A0216	16"	Zinc	10 pair
FUNJ81A0218	18"	Zinc	10 pair
FUNJ81A0220	20"	Zinc	10 pair
FUNJ81A0222	22"	Zinc	10 pair

## DYNASLIDE®

### Center Mount 3/4 Extension With Adjustable Rear Bracket - Dynaslide



- Features: Mounting under drawer.
- Friction disconnect.
- Rear mounting bracket to adjust to cabinet depth.
- Slide concealed under drawer.
- Load rating 35 lbs/pr.

Applications: Bedroom, bath, and kitchen cabinets

Part Number	Slide Length Inches	Fit Drawer Length Inches	Fits Cabinet Depth Inches	Slide Travel Inches	Finish	Slides per Box
DS350814	14 3/4"	12 16/25" - 14 12/25"	15" - 16 12/25"	10 43/64"	Zinc	10
DS350816	16 3/4"	14 16/25" - 16 12/25"	17" - 18 1/2"	12 13/64"	Zinc	10
DS350818	18 3/4"	16 3/5" - 18 1/2"	19" - 20 1/2"	12 9/16"	Zinc	10
DS350820	20 3/4"	18 3/5" - 20 1/2"	20 24/25" - 22 1/2"	15 31/64"	Zinc	10



## Full Extension Hold-Out Precision Drawer Slide



- Features: 32mm hole pattern with direct access mounting.
- Lever disconnect for easy drawer removal.
- Hold-out feature allows slide to be held in place when drawer is open.
- Telescopic movement on ball bearings.

Applications: Computer keyboard or pencil drawer

Part Number	Slide Length Inches	Load Rating lbs/pr	Finish	Slides per Box
KV8414B14	14"	100	Zinc	10 pair

## 4 x 4 Pocket Door Slides - KV 8091



- Features: Rack and pinion design.
- Multiple hinge options.
- Greatly reduces door sag.
- Max dimensions for vertical doors 72" High x 26" Wide.
- Load rating 75 lb class
- Hinges and Baseplates Not Included
- Needs Pinion Shaft, Sold Separately see next page.

Applications: Concealed door

Part Number	Slide Length Inches	Finish	Slides per Box
KV8091PEB16	16"	Black	1 pair
KV8091PEB18	18"	Black	1 pair
KV8091PEB20	20"	Black	1 pair
KV8091PEB22	22"	Black	1 pair
KV8091PEB24	24"	Black	1 pair
KV8091PEB30	30"	Black	1 pair



## Pinion Shaft



48" Shaft  
Part Number: KV8092SB48B

72" Shaft  
Part Number: KV8092SB72B

Packed 2 per Box



## Ball Bearing Pocket Door Slides

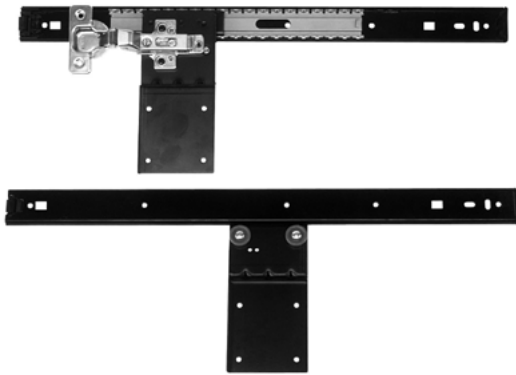

Features: Unique bracket design.  
Pre-drilled for mounting plates.  
Pre-drilled for wood follower-strip.

Applications: Concealed door

Part Number	Slide Length Inches	Slide Travel Inches	Finish	Slides per Box
KV8071PEZ16B	16"	12 5/16"	Black	20 pair
KV8071PEZ18B	18"	14 5/16"	Black	20 pair
KV8071PEZ20B	20"	16 5/16"	Black	20 pair
KV8071PEZ22B	22"	19 3/32"	Black	20 pair

## Ball Bearing Pocket Door Slides



Features: Formed bracket for easy installation of Wood follower-strip.  
Positive detent-out to hold door open.  
Used on inset or overlay doors.  
Load rating 50 lbs based on 18" slides.

Slides

Applications: Concealed door

Part Number	Slide Length Inches	Slide Travel Inches	Finish	Slides per Box
PR200016	16"	12 5/8"	Zinc	10 pair
PR200018	18"	14 5/8"	Zinc	10 pair
PR200020	20"	16 5/8"	Zinc	10 pair
PR200022	22"	18 5/8"	Zinc	10 pair

## Hinge/Roller Kit for Pocket Door Slides

Part Number: 7109POCK

## Hinge/Roller Kit for KV8071 Pocket Door Slides

Part Number: 7109POCK5727

## Pocket Door Roller



Plastic  
Part Number: 7144740

Use with 8x3/4 Phil Pan TSA

## Plastic Pocket Door

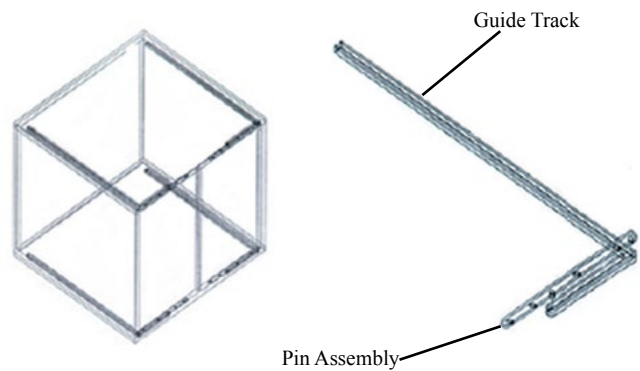

Part Number: 7113PD

## Light Duty 3/4 Extension Center, Adjustable Brackets Keyboard Slides

Slides



Features: Positive detent-out and detent-in.  
Adjustable height bracket.  
Adjustable in- or outboard bracket.  
Mounting tabs for keyboard shelf.

Applications: Computer keyboard or pencil drawer

Part Number	Slide Length Inches	Slide Travel Inches	Load Rating lbs/pr	Finish	Slides per Box
PR305014BK	14"	9 1/2"	60	Black	10 pair

## **DYNASLIDE®** Light Duty 3/4 Extension Center Keyboard Slides - Dynaslide



Features: Positive detent-out and detent-in.  
Adjustable height bracket.  
Adjustable in- or outboard bracket.

Applications: Computer keyboard or pencil drawer

Part Number	Slide Length Inches	Slide Travel Inches	Load Rating lbs/pr	Finish	Slides per Box
DS355414	14"	9 15/16"	60	Zinc	20 pair
DS355416	16"	11 3/8"	60	Zinc	20 pair



## 3/4 Extension Variable-Height Pencil Drawer Slide



Features: Positive detent-out and detent-in.  
Mounting brackets adjust to 7 heights and can be reversed for inboard/outboard mounting.  
Anti-rebound stay-close design holds pencil drawer in closed position yet allows for easy opening.  
Track member quickly disconnects using positive lever releases

Applications: Computer keyboard or pencil drawer

Part Number	Slide Length Inches	Load Rating lbs/pr	Finish	Slides per Box
KV8250P14	14"	75	Zinc	10 pair
KV8250P16	16"	75	Zinc	10 pair
KV8250P20	20"	75	Zinc	10 pair

## Light Duty 3/4 Extension Center Keyboard Slides



Features: Fixed height bracket (2").  
Side mounting for shelf or drawer.

Applications: Computer keyboard or pencil drawer

Part Number	Slide Length Inches	Slide Travel Inches	Load Rating lbs/pr	Finish	Slides per Box
PR340018BK	18"	12 1/2"	60	Black	10

## Slide-Pencil Drawer Tray

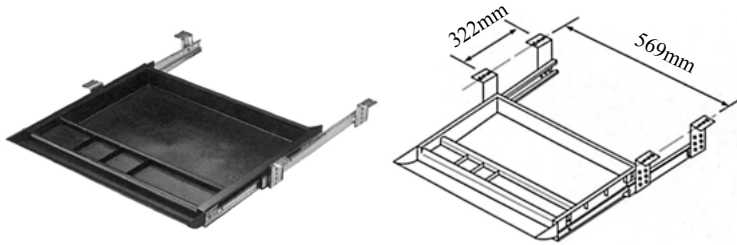

Mounted on ball bearing slides.  
Mounts under desk with adjustable brackets.  
Keyboard Tray Dimensions  
530mm L x 470mm W x 48mm H  
Black

Part Number: FU89710B

## Keyboard Drawer with Mouse Tray

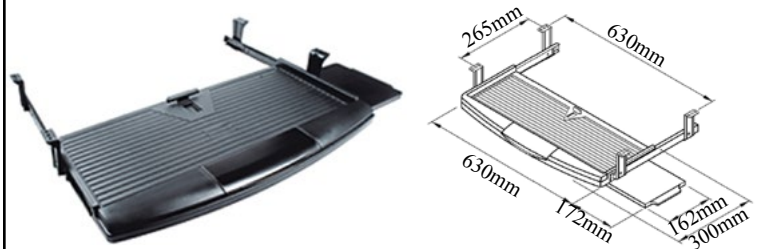

Adjustable keyboard with pull out mouse tray, height adjustable brackets and hold-in/hold-out detent.  
Accessory compartment in front.  
Keyboard Tray Dimensions: 630mm W x 300mm L  
Black

Ergonomics

Part Number FU89230BK

## Slide - Economy Under Desk Keyboard Drawer

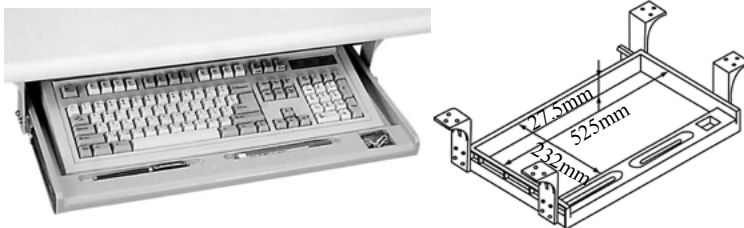

Pre-mounted with smooth ball bearing slides with spring locks and nylon mounting brackets.  
Keyboard Tray Dimensions  
525mm W x 232mm L x 27.5mm H  
Light Grey

Part Number: FU89210



## Keyboard Arm



17" Teflon glide track.  
Soft touch knob for simultaneous height and tilt adjustment.  
Spring assisted to help counter balance keyboard and tray weight.  
Low profile design.  
Store on glide track.  
+15 degree/- 15 degree tilt adjustment.  
360 degree swivel.

Part Number: KV5733M17

## Keyboard Drawer With Mouse Tray

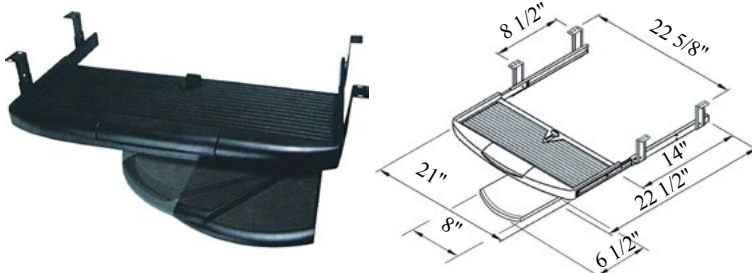

Smooth and silent moving with ball bearing slide and easy to assemble L-brackets.  
Flip out mouse tray.  
Pencil box with cover in front.  
Keyboard holding device secures steady operation.  
Keyboard Tray Dimensions: 21" W x 22 1/2" L  
Black

Part Number: FU6021112048

## "Lazy Susan" Swivel Round Metal With Ball Bearings



Outer Diameter: 9"  
Inner Diameter: 4.5"  
Load Capacity: 750 lbs

Part Number: 714809R

Outer Diameter: 12"  
Inner Diameter: 6.33"  
Load Capacity: 1,000 lbs

Part Number: 7148112R

Swivels

## Light Duty Square Swivel Metal

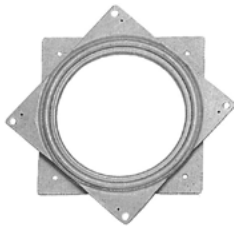

Outer Dimensions: 4" x 4"  
Inner Diameter: 2 3/16"  
Load Capacity: 300 lbs

Part Number: 714804S

Outer Dimensions: 6" x 6"  
Inner Diameter: 4 11/16"  
Load Capacity: 500 lbs

Part Number: 714806S

## Square Swivel Metal



Outer Dimensions: 7"  
Load Capacity: 500 lbs

Part Number: 714807S

## Pull Out Swivels

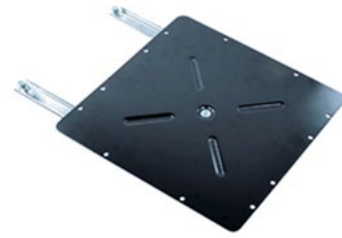

Extension: Full  
Closed Length: 15" 380mm  
Travel: 15" 380mm  
Height: 2" 50mm  
Load Capacity: 150 lbs  
Color: Black

Part Number: 7342393300

## Maple Bottom Mount Waste Container



Bring style and affordability to your kitchen with Rev-A-Shelf's 4WC Series. Designed for 15", 18" and 24" base cabinets, the 4WC Series offers a natural maple dovetail frame with semi-gloss finish, two slide configurations and patented pre-assembled door mount brackets (US Patent No. 6,390,576).  
 White bins.

Part Number	Slide Type	Height	Width	Depth	Quart Size	# of Bins
RV4WC15DM1	Ball Bearing	19 1/4"	11 1/4"	21 3/4"	35	1
RV4WC18DM2	Ball Bearing	19 1/4"	14 1/4"	21 3/4"	35	2
RV4WC24DM2SC	Soft Close Undermount	19 5/8"	20 31/32"	22 1/4"	30	2

\*RV4WC24DM2SC - Bins are silver.

## Maple Bottom Mount Waste Container with Rev-A-Motion



The 4WCBM Series Waste Containers are the only bottom mount units available with Rev-A-Shelf's patented Rev-A-Motion soft-open soft-close slide system. All units feature metallic silver waste containers and built-in door mount brackets. (US Patent No. 8,091,971)

Part Number	Height	Width	Depth	Quart Size	# of Bins
RV4WCBM15DM1	21 3/4"	12"	19 1/4"	35	1
RV4WCBM1550DM1	23 3/16"	12"	21 3/4"	50	1
RV4WCBM18DM216	19 1/4"	14 1/4"	21 3/4"	35	2
RV4WCBM2150DM212	23 3/16"	17 1/4"	21 3/4"	50	2
RV4WCBM2430DM2	19 1/4"	20 1/4"	21 3/4"	30	2

## Maple Wood Bottom Mount Waste Container



The 4WCSC Waste Containers feature beautiful wood dovetail construction and glides on a full-extension soft-close under-mount slide system.

Convenience Hardware

Part Number	Height	Width	Depth	Quart Size	# of Bins
RV4WCSC1535DM1	19 1/2"	12"	21 21/32"	35	1
RV4WCSC1550DM1	23 3/8"	12"	21 3/4"	50	1
RV4WCSC1835DM216	20 3/8"	15"	21 3/4"	35	2
RV4WCSC1835DMND2	20 3/8"	15"	21 3/4"	35	2
RV4WCSC2135DM2	20 3/8"	18"	21 3/4"	35	2
RV4WCSC2150DM212	24 1/4"	18"	21 3/4"	50	2

## Maple Wood Bottom Mount Waste Container with Servo-Drive



The 4WCSD Waste Containers feature beautiful wood dovetail construction with full-extension soft-close slide system. Patented adjustable door mount brackets will let you mount your cabinet door directly to your waste container for easy access. Also features a Blum Servo-drive electric system (electrical outlet required). Simply touch-to-open. That's it.

Part Number	Height	Width	Depth	Quart Size	# of Bins
RV4WCSD1535DM1	19 1/2"	12"	22 1/2"	35	1
RV4WCSD1550DM1	23 3/8"	12"	22 1/2"	50	1
RV4WCSD1835DM2	19 1/2"	15"	22 1/2"	35	2
RV4WCSD2150DM2	24 1/4"	18"	22 1/2"	50	2

## Maple Top Mount Waste Container



Convenience Hardware

Rev-A-Shelf's 4WCTM Series designed with durability in mind is available in a multitude of sizes. The 4WCTM Series is available in both single, double and quad configurations and features a natural maple frame that glides on full-extension soft close slides.

Part Number	Height	Width	Depth	Quart Size	# of Bins
RV4WCTM12BBSCDM1	17 7/8"	12"	22 3/4"	35	1
RV4WCTM1550BBSCDM1	21 3/4"	12"	23 1/4"	50	1
RV4WCTM15BBSCDM2	17 3/4"	12"	23 1/4"	27	2
RV4WCTM18BBSCDM2	17 7/8"	15"	22 3/4"	35	2
RV4WCTM2150BBSCDM2	21 3/4"	18"	23 1/4"	50	2
RV4WCTM2450BBSCDM2	21 3/4"	21"	22 1/2"	50	2

## Aluminum Bottom Mount Waste Container with Rev-A-Motion



Rev-A-Shelf's 5149 series adds a pinch of luxury to your trash. The sleek anodized aluminum frame glides in and out on the patented soft-close slide system. Door mount brackets included and can adjust to almost any door style.

Part Number	Height	Width	Depth	Quart Size	# of Bins
RV51491527DM217	19 1/2"	12 1/8"	22"	27	2
RV514915DM117	19 1/2"	12 1/8"	22"	35	1
RV514915DM18117	19 1/2"	12 1/8"	18"	35	1
RV51491550DM117	23 1/2"	12 1/8"	22"	50	1
RV514918DM21716	19 1/2"	14 3/16"	22"	35	2
RV51492150DM217	23 1/2"	15 5/8"	22"	50	2

## Aluminum Bottom Mount Waste Container with Soft Close



Rev-A-Shelf's 5349 series waste containers are definitely the premiere waste containers. These units are manufactured with Italian influences with brushed aluminum frame and soft closing slides that glide in and out with complete ease. The included door mount hardware finish the look and allow you to mount your existing cabinet door directly to the waste container. Get your waste container off the floor and hide it inside one of your base cabinets.

Part Number	Height	Width	Depth	Quart Size	# of Bins
RV53491527DM217	18 15/16"	11 11/16"	22 1/4"	27	2
RV53491550DM117	23 1/8"	10 3/4"	21 15/16"	50	1
RV534915DM117	19 1/4"	10 3/4"	21 15/16"	35	1
RV534915DM18117	19 5/16"	10 13/16"	18"	35	1
RV534918DM21716	19 1/16"	14 13/16"	22 1/8"	35	2
RV53492150DM21712	22 15/16"	14 13/16"	22 1/8"	50	2

Door Mount Extender Bracket  
 for 5349:  
 RV5345DMKIT1



## Steel Bottom Mount Waste Container with Soft Close



Rev-A-Shelf's 53WC series is going to add a touch of luxury with this it's modern Italian design and the durability you come to expect. Available in multiple sizes and 3 finishes to match any kitchen decor. Features soft-close slides system, door mount kit and simple installation.

Part Number	Height	Width	Depth	Quart Size	# of Bins
RV53WC1527SCDM217	19"	11 1/4"	22 3/32"	27	1
RV53WC1535SCDM117	19"	10 7/8"	22 1/4"	35	1
RV53WC1550SCDM117	23"	10 7/8"	22 1/4"	50	1
RV53WC1835SCDM21720	19"	14 3/8"	22 1/4"	35	2
RV53WC2150SCDM21720	23"	14 3/4"	22 1/4"	50	2

## Wire Bottom Mount Waste Container



The RV Series of wire frame waste container pullouts offers several sizes, finishes and slide options to accommodate a variety of cabinet openings, styles and price points.

Part Number	Height	Width	Depth	Quart Size	# of Bins
RVRV12PB	19"	10 5/8"	22"	35	1
RVRV12PBLE	20 3/8"	10 5/8"	16"	35	1
RVRV15KD17CS	19 1/4"	11 13/16"	22 1/4"	27	2
RVRV15PB2S	19 1/8"	11 13/16"	22 1/4"	27	2
RVRV18KD17CS	19 1/4"	14 3/8"	22"	35	2
RVRV18PB2S	19 1/4"	14 3/8"	22"	35	2

## Tandembox Bottom Mount Waste Container with Servo-Drive



Rev-A-Shelf brings you another complete waste container designed for base cabinets. Complete with Blum SERVO-DRIVE touch-to-open technology, they come pre-assembled with TANDEMBOX and heavy duty full extension soft-close slide system.

Convenience Hardware

Part Number	Height	Width	Depth	Quart Size	# of Bins
RVTWCSD18DM2	19"	15 1/2"	22 5/8"	35	2
RVTWCSD2150DM2	23"	18 1/2"	22 5/8"	50	2

## Door Mount Kits



Part Number	Description	Color
RVRVDM17KIT	Door Mounting Kit for Wire Waste Container Series	Silver
RVRVDMKIT	Door Mounting Kit for Wire Waste Container Series	White

## Replacement Waste Container and Lids



Part Number	Size	Color
RVRV3517	35 Quart	Silver
RVRV35	35 Quart	White
RVRV5017	50 Quart	Silver
RVRV50	50 Quart	White

Part Number	For	Color
RVRV35LID171	35 Quart	Silver
RVRV35LID1	35 Quart	White
RVRV50LID171	50 Quart	Silver
RVRV50LID1	50 Quart	White



## Classic Wood Full Circle Lazy Susan



Convenience  
Hardware

Rev-A-Shelf's 4WLS series (2) shelf full circle wood lazy susans are revered as the best on the market. Whether you are replacing an old unit or just adding a lazy susan to your wall corner cabinet, you will not be disappointed with the high-quality construction and the durable rotating hardware that makes installation simple.

Part Number	Mount	Post Height	Diameter	# of Shelves	Color
RV4WLS0721852	Top/Bottom	26" - 32"	18"	2	Maple
RV4WLS0722852	Top/Bottom	26" - 32"	28"	2	Maple
RV4WLS0723252	Top/Bottom	26" - 32"	32"	2	Maple
RV4WLS07318536	Top/Bottom	38" - 46"	18"	3	Maple

## 2-Shelf Classic Wood Pie-Cut Lazy Susan



Rev-A-Shelf's 4WLS series pie cut wood lazy susans for 90-degree wall corner applications are revered as the best on the market. Whether you are replacing an old unit or just adding a lazy susan to your corner cabinet, you will not be disappointed with the high-quality construction and the durable rotating hardware that makes installation simple.

Part Number	Mount	Post Height	Diameter	# of Shelves	Color
RV4WLS9422852	Top/Bottom	26" - 32"	28"	2	Maple

## Single Shelf Classic Wood Kidney Lazy Susan



Rev-A-Shelf's 4WLS series kidney wood lazy susans are revered as the best on the market. Whether you are replacing an old unit or just adding a lazy susan to your corner cabinet, you will not be disappointed with the high-quality construction and the durable rotating hardware that makes installation simple.  
Aluminum Bearing.

Part Number	Mount	Height	Diameter	# of Shelves	Color
RV4WLS40128BS8	Top/Bottom	2 3/8"	28"	1	Maple
RV4WLS40132BS52	Top/Bottom	2 3/8"	32"	1	Maple

## Single Shelf Wood Kidney Lazy Susan



Rev-A-Shelf's 4BW series kidney lazy susans for base corner applications are revered as the best on the market. Whether you are replacing an old unit or just adding a lazy susan to your corner cabinet, you will not be disappointed with the high-quality construction.  
Steel Bearing

Part Number	Mount	Height	Diameter	# of Shelves	Color
RVLD4BW40128SBS1	Top/Bottom	2 15/16"	28"	1	Maple
RVLD4BW40132SBS1	Top/Bottom	2 15/16"	32"	1	Maple

## 2-Shelf Classic Wood Kidney Lazy Susan



Rev-A-Shelf's 4WLS series (2) shelf kidney wood lazy susans are revered as the best on the market. Whether you are replacing an old unit or just adding a lazy susan to your corner cabinet, you will not be disappointed with the high-quality construction and the durable rotating hardware that makes installation simple.

Part Number	Mount	Post Height	Diameter	# of Shelves	Color
RV4WLS4722452	Top/Bottom	26" - 32"	24"	2	Maple
RV4WLS4722852	Top/Bottom	26" - 32"	28"	2	Maple
RV4WLS4723252	Top/Bottom	26" - 32"	32"	2	Maple

## 2-Shelf Wood Kidney Lazy Susan



Rev-A-Shelf's 4BW series (2) shelf kidney lazy susans for base corner applications are revered as the best on the market. Whether you are replacing an old unit or just adding a lazy susan to your corner cabinet, you will not be disappointed with the high-quality construction.

Part Number	Mount	Post Height	Diameter	# of Shelves	Color
RVLD4BW472241	Top/Bottom	26" - 31"	24"	2	Maple
RVLD4BW472281	Top/Bottom	26" - 31"	28"	2	Maple
RVLD4BW472321	Top/Bottom	26" - 31"	32"	2	Maple

## Polymer Full Circle Lazy Susan



Rev-A-Shelf's polymer lazy susans are revered as the best on the market. Whether you are replacing an old unit or just adding a lazy susan to your corner cabinet, you will not be disappointed with the high quality design and the durable rotating hardware that makes installation simple.

Convenience  
Hardware

Part Number	Mount	Post Height	Diameter	# of Shelves	Color
RV6012181152	Top/Bottom	24" - 31"	18"	2	White
RV6012241152	Top/Bottom	24" - 31"	24"	2	White
RV6012281152	Top/Bottom	24" - 31"	28"	2	White
RV6072321152	Top/Bottom	26" - 32"	32"	2	White



Rev-A-Shelf's polymer lazy susans are revered as the best on the market. Whether you are replacing an old unit or just adding a lazy susan to your corner cabinet, you will not be disappointed with the high quality design and the durable rotating hardware that makes installation simple.

Part Number	Mount	Post Height	Diameter	# of Shelves	Color
RV60131811526	Top/Bottom	38" - 46"	18"	3	White
RV60132011526	Top/Bottom	38" - 46"	20"	3	White

## Classic Wood Half Moon Lazy Susan



Convenience Hardware

Rev-A-Shelf's 4WLS series half moon wood lazy susans for base blind corner cabinets are revered as the best on the market. Whether you are replacing an old unit or just adding a lazy susan to your base blind corner cabinet, you will not be disappointed with the high-quality construction and the durable pivot and pull hardware.

Part Number	Width	Post Height	Depth	# of Shelves	Color
RV4WLS88232570	12" - 32"	18"	32"	2	Maple
RV4WLS88235570	15" - 35"	18"	35"	2	Maple
RV4WLS88238570	18" - 38"	18"	38"	2	Maple

## Polymer Half Moon Lazy Susan



Rev-A-Shelf's polymer half moon organizers for base blind corners are revered as the best on the market. Whether you are replacing an old unit or just wanting to access your base corner cabinets, you will not be disappointed with the high quality design and the durable mounting hardware with ball-bearing slides. Pivot/Slide

Part Number	Mount	Height	Diameter	# of Shelves	Color
RV68823111570	Top/Bottom	15 7/8"	31"	2	White
RV68823311570	Top/Bottom	15 7/8"	33"	2	White
RV68823911570	Top/Bottom	15 7/8"	39"	2	White

## 2-Shelf Polymer Pie Cut Lazy Susan



Rev-A-Shelf's polymer lazy susans are revered as the best on the market. Whether you are replacing an old unit or just adding a lazy susan to your corner cabinet, you will not be disappointed with the high quality design and the durable rotating hardware that makes installation simple.

Part Number	Mount	Post Height	Diameter	# of Shelves	Color
RV6942241152	Top/Bottom	26" - 32"	24"	2	White
RV6942281152	Top/Bottom	26" - 32"	28"	2	White

## 2-Shelf Polymer Kidney Lazy Susan



Rev-A-Shelf's polymer lazy susans are revered as the best on the market. Whether you are replacing an old unit or just adding a lazy susan to your corner cabinet, you will not be disappointed with the high quality design and the durable rotating hardware that makes installation simple.

Part Number	Mount	Post Height	Diameter	# of Shelves	Color
RV6472241152	Top/Bottom	26" - 32"	24"	2	White
RV6472281152	Top/Bottom	26" - 32"	28"	2	White
RV6472321152	Top/Bottom	26" - 32"	32"	2	White

## The “Cloud” Contemporary Single Blind Corner



←Left hand shown.

Add convenience to your blind corner storage with Rev-A-Shelf's 5370 Series. Designed for 15", 18" and 21" blind corner cabinet openings, these cloud-shaped shelves feature natural maple or gray solid bottoms and round or flat wire accents.

Part Number	Size	# of Shelves	Handed	Wood
RV537115MPL	15"	1	Left	Maple
RV537115MPR	15"	1	Right	Maple
RV537118MPL	18"	1	Left	Maple
RV537118MPR	18"	1	Right	Maple

## The “Cloud” Contemporary Double Blind Corner

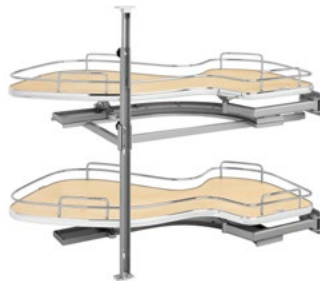

←Left hand shown.

Add convenience to your blind corner storage with Rev-A-Shelf's 5370 Series. Designed for 15", 18" and 21" blind corner cabinet openings, these cloud-shaped shelves feature natural maple or gray solid bottoms and round or flat wire accents.

Part Number	Size	# of Shelves	Handed	Wood
RV537215MPL	15"	2	Left	Maple
RV537215MPR	15"	2	Right	Maple
RV537218MPL	18"	2	Left	Maple
RV537218MPR	18"	2	Right	Maple

## Blind Corner Optimizer



Convenience  
Hardware

Rev-A-Shelf's 53PSP Series maximizes space in blind corner cabinets while allowing the user full accessibility to the entire unit. The unit is easy to assemble and installs for either left or right-handed applications. This blind corner optimizer fits most 45" & 48" door/drawer or full-height blind corner cabinets and features solid bottom shelves, soft-close ball-bearing slides and heavy duty materials making it functional, reliable and stylish.

Part Number	Width	Height	Depth	Color
RV53PSP15SCMP	26 1/4"	21"	20 1/4"	Maple
RV53PSP18SCMP	32 1/4"	21"	20 1/4"	Maple

## Wire Blind Corner Optimizer

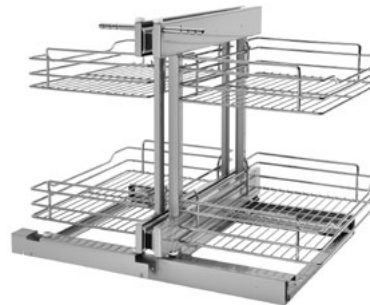

Rev-A-Shelf's 5PSP Series maximizes space in blind corner cabinets while allowing the user full accessibility to the entire unit. The unit is easy to assemble and installs for either left or right-handed applications. This chrome blind corner optimizer fits most 48" blind corner cabinets and features chrome accents, soft-close ball-bearing slides and heavy duty materials making it functional, reliable and stylish.

Part Number	Width	Height	Depth	Color
RV5PSP15SCCR	26 1/4"	21"	20 1/4"	Chrome
RV5PSP18SCCR	32 1/4"	21"	20 1/4"	Chrome

## Wood Pantry Pull Out - Soft Close



Convenience  
Hardware

Rev-A-Shelf wood pantry system will maximize your storage space with this fabulous and functional pullout pantry. Available in four widths and three heights, it rides on our heavy duty soft-close slide system and boasts unprecedented adjustment and strength. Constructed of beautiful wood, adjustable shelves, door mount brackets, a telescoping rear wall and included all mounting hardware.

Part Number	Width	Height	Depth	Wood
RV448TP4381	8"	43 1/4"	22"	Maple
RV448TP43111	11"	43 1/4"	22"	Maple
RV448TP43141	14"	43 1/4"	22"	Maple
RV448TP5151	5"	50 3/4"	22"	Maple
RV448TP5181	8"	50 3/4"	22"	Maple
RV448TP51141	14"	50 3/4"	22"	Maple
RV448TP5881	8"	58 1/4"	22"	Maple
RV448TP58141	14"	58 1/4"	22"	Maple

## Tiered Wall Filler with Ball Bearing Soft Close Slides



Rev-A-Shelf's fillers revolutionized otherwise wasted space in your kitchen. Normally a "filler" or extra space is simply covered up with a decorative front, but with Rev-A-Shelf's line of fillers, it turns that otherwise wasted space in to useful space. Fillers are intended to be installed in new kitchen cabinet construction and will not work in existing cabinets. The 432 Wall Series is available for 3" and 6" widths and features adjustable shelves with chrome rails and full-extension ball bearing slides.

Part Number	Width	Height	Depth	Wood
RV432WFBBS303C	3"	30"	11 1/8"	Maple
RV432WFBBS306C	6"	30"	11 1/8"	Maple
RV432WFBBS423C	3"	42"	11 1/8"	Maple
RV432WFBBS426C	6"	42"	11 1/8"	Maple

## Wall Cabinet Pull-Out



Do you need that one item in the back of your wall cabinet, and the only way to access it is to pull everything out? Stop the madness with Rev-A-Shelf's pullout shelving system, whose open design ensures you can effortlessly find everything. Available in varying heights and sizes, they door mount giving you a uniquely customized look and easy operation.

Part Number	Width	Height	Depth	Wood
RV448BBSCWC5C	5"	26 5/32"	10 3/4"	Maple
RV448BBSCWC8C	8"	26 5/32"	10 3/4"	Maple

## Base Filler with Full Extension Slides



Rev-A-Shelf's fillers revolutionized otherwise wasted space in your kitchen. Normally a "filler" or extra space is simply covered up with a decorative front, but with Rev-A-Shelf's line of fillers, it turns that otherwise waste space in to useful space. Fillers are intended to be installed in new kitchen cabinet construction and will not work in existing cabinets.

Part Number	Width	Height	Depth	Slide Type	Wood
RV432BFBS306C	6"	30"	23"	Soft Close	Maple
RV432BFSC3C	3"	30"	23"	Full Extension	Maple
RV432BFSC6C	6"	30"	23"	Full Extension	Maple

## Base Organizer with Blumotion Soft Close



The 438 Series may look like our 432 Series products (that mount in between cabinets), however the 438's are sized to enable them to be used inside of a full height base cabinet. A great way to add organization to full height 6" & 9" cabinets.

Part Number	Width	Height	Depth	Wood
RV438BCSC3C	3"	27 5/16"	23"	Maple
RV438BCSC6C	6"	27 5/16"	23"	Maple

## Base Cabinet Pull Out



Rev-A-Shelf's beautiful base organizers feature adjustable shelves with chrome rails to help keep everything in its place. Units are stocked in BLUMOTION soft-close. Door mounting is easy with our patented door mount brackets that provide up to 5 inches of flexibility for trouble free installation on any door style.

Part Number	Width	Height	Depth	Wood
RV448BCSC5C24	6"	25 1/2"	21 5/8"	Maple
RV448BCSC6C	7 1/4"	25 1/2"	21 5/8"	Maple
RV448BCSC8C16	8 3/4"	25 1/2"	21 5/8"	Maple
RV448BCSC9C	10 1/4"	25 1/2"	21 5/8"	Maple
RV448BCSC11C	11 3/4"	25 1/2"	21 5/8"	Maple

## Base Cabinet Pull Out with Knife Block and Utensil Bins



RV448KBBCSC8C

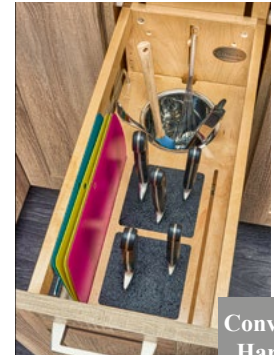

RV448KBBCSC9C

Convenience Hardware



RV448KBBCS11C

Every great chef knows that you are only as good as your knives but having so many sizes and brands makes storing them a nightmare. That is no longer a concern with our patented 448KB Series Organizer with Blumotion soft-close. This unit features universal knife inserts, lower shelf storage, stainless steel utensil bin, and an adjustable top shelf. US Patent No. 8,388,076 and 10,799,020

Part Number	Width	Height	Depth	Wood
RV448KBBCSC8C	8 3/4"	25 1/2"	21 5/8"	Maple
RV448KBBCSC9C	10 1/4"	25 1/2"	21 5/8"	Maple
RV448KBBCSC11C	11 3/4"	25 1/2"	21 5/8"	Maple

## Base Cabinet Pull Out with Utensils



Convenience  
Hardware

Rev-A-Shelf's beautiful base organizers feature adjustable shelves with chrome rails to help keep everything in its place. Stop digging through drawers for utensils and say goodbye to unsightly, space monopolizing counter bins with the 448UT pull-out designed specifically for storing a multitude of utensils. Units glide out on the BLUMOTION soft-close slide system, which is some of the industry best slides. Door mounting is easy with our patented door mount brackets that provide up to 5 inches of flexibility for trouble free installation on any door style.

Part Number	Width	Height	Depth	Wood
RV448UTBCSC5C	6"	25 1/2"	21 5/8"	Maple
RV448UTBCSC8C	8 3/4"	25 1/2"	21 5/8"	Maple

## Base Cabinet Pull Out with Tray Divider with Blumotion Soft-Close



Rev-A-Shelf's baking storage has never been more versatile than with the 447 Pullout Organizer. These organizers feature two compartments for storing baking sheets and platters and the removable center racks allow you the ability to store large platters and bake ware if desired. The unit is made from Maple and glides on our patented "tri-slides" for stability. Door mounting is a breeze with our patented door mount brackets that provide up to 5 inches of flexibility for trouble free installation on any door style.

Part Number	Width	Height	Depth	Wood
RV447BCSC5C	6"	19 1/2"	21 21/32"	Maple
RV447BCSC8C	8 3/4"	19 1/2"	21 21/32"	Maple

## Glideware™ Pull-Out



Glideware(TM) is a revolutionary organizing pullout that allows you to securely hang your accessories like cookware inside of your cabinet and brings them out only when you want them. Designed for 14" to 22" cabinet depths, the patent-pending Glideware(TM) Pullouts feature up to seven adjustable hooks, solid wood construction in either maple or gray, and two slide configuration.

Part Number	Width	Height	Depth	Color
RVGLDW22BC7	6"	5 1/16"	22"	Maple

## 2-Tier Cookware Organizer

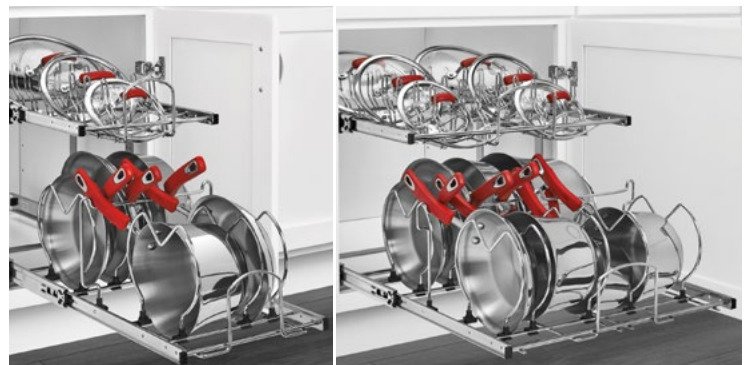

Revolutionize the way you store your pots, pans, and lids with Rev-A-Shelf's Two-Tier Cookware Organizer. The 5CW2 features independently operating shelves that accommodate a variety of cookware sizes and brands. The top tier organizes lids and the bottom tier features adjustable dividers to store a variety of large pots and pans. Made with a heavy duty chrome plated wire frame and 100 lb. rated full-extension soft-close ball-bearing slides. The bottom, side, and rear mounting provide you the sturdiness you expect and easy installation. Optional Door mounting kit available with the 5WB-DMKIT.

Part Number	Width	Height	Depth	Color
RV5CW21222SCCR	11 3/4"	18"	22"	Chrome
RV5CW22122SCCR	20 3/4"	18 1/8"	22"	Chrome

## Chrome Wire Pull Out Shelves



These single and two-tier chrome wire baskets are ideal for organizing your valuable pots, pans, and other bulky items! The 5WB Series Baskets are available in (3) depths and (5) widths to fit many different application.

Part Number	Width	Height	Depth	# of Shelves
RV5WB11222CR	11 1/2"	5 9/16"	22"	1
RV5WB11520CR	14 1/2"	5 9/16"	19 3/4"	1
RV5WB11522CR	14 1/2"	5 9/16"	22"	1
RV5WB11822CR	17 1/2"	5 9/16"	22"	1
RV5WB12122CR	20 1/2"	5 9/16"	22"	1
RV5WB21222CR	11 3/4"	19"	22 1/4"	2
RV5WB21522CR	14 3/4"	19"	22 1/4"	2
RV5WB22122CR	20 3/4"	19"	22 1/4"	2

## Mixer Lift



Rev-A-Shelf has kept design and flexibility in mind, the heavy duty lift can be attached to any custom made shelf and therefore will fit all full height cabinet sizes allowing a perfect match to your counter top or interior cabinet. The RAS-ML-HDSC features built-in shock dampeners, adjustable spring tension and holds appliances up to 60 lbs. Already regarded as the best in the industry our heavy duty mixer lift leaps even further ahead of the competition with the addition of soft-close.

Part Number	Depth	Type	Color
RVRASMLHDCR	23"	Standard	Silver
RVRASMLHDSC	23"	Soft-Close	Silver
RVMLMPHDSCCR18	23"	Standard Heavy Duty with Maple Shelf	Silver

## Drawer Peg System

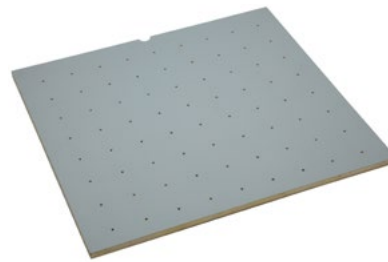

### No Pegs

Rev-A-Shelf has made it easy to organize your deep drawers with our wood peg board. Available in three standard sizes, each size can be trimmed to fit and with the easy drop-in installation you can take your drawer from drab and messy to chic and orderly within seconds.

Part Number	Width	Height	Depth	Color
RV4DPBG24211	24 1/4"	5/8"	21 1/4"	Gray
RV4DPBG30211	30 1/4"	5/8"	21 1/4"	Gray
RV4DPBG39211	39 1/4"	5/8"	21 1/4"	Gray

Convenience  
Hardware



Stainless Steel Drawer Pegs  
Packed 4/set  
Part Number: RVDPSPEG4SS

## Drop-In Organizers

Organization is one thing every good chef has in common and now you can too with the use of our deep drawer accessories. Designed to work with our 4DPB, 4DPS and 4DPBG peg boards these easy, press-in components keeps items organized, in reach, and when used in combination with one another you have a complete cooking station at your fingertips.

### Drop-In Pan Organizer



Part Number	Width	Height	Depth	Color
RV5DCD1CR	7 3/4"	7 5/8"	15 1/4"	Chrome

### Drop-In Lid Organizer



Part Number	Width	Height	Depth	Color
RV5DLLD1CR	5 1/4"	5 3/8"	16 7/8"	Chrome



## Drawer Peg System

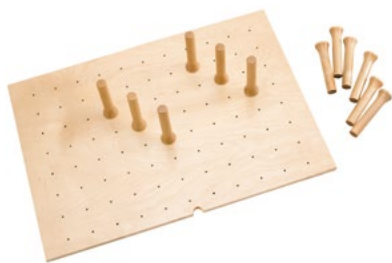

Convenience  
Hardware

Rev-A-Shelf has made it easy to organize your deep drawers with our wood peg board. Available in three standard sizes, each size can be trimmed to fit and with the easy drop-in installation you can take your drawer from drab and messy to chic and orderly within seconds.

Part Number	Width	Height	Depth	Color
RV4DPS2421	24 1/4"	6 5/8"	21 1/4"	Maple
RV4DPS3021	30 1/4"	6 5/8"	21 1/4"	Maple
RV4DPS3921	39 1/4"	6 5/8"	21 1/4"	Maple



Wood Drawer Pegs  
Packed 4/set  
Part Number: RV4DPSPEG4

## Sliding Spice/Can Rack



Stop looking at your pantry head-on and start seeing things from a different, more accessible angle with our Deluxe Sliding Spice/Can Rack. Their unique design lets you see items entirely just by pulling the product out of the cabinet. See what you have at a glance!

Part Number	Width	Height	Depth	Color
RV5WSCR18CR1	18"	2 13/16"	14"	Chrome
RV5WSCR24CR1	24"	2 13/16"	14"	Chrome
RV5WSCR30CR1	30"	2 13/16"	14"	Chrome

## Sliding Wine Rack



Create a pantry or bar that is the envy of all your friends with Deluxe Sliding Wine Racks. Their unique design lets you see your wine bottles entirely just by pulling the product out of the cabinet. Go from selection to serving is just seconds! Available in three sizes, 18", 24" and 30", it glides on full-extension slides, and the angled design keeps your corks wet, preventing spoilage. So, don't wait any longer, get the wine storage solution that any Sommelier would be proud to have.

Part Number	Width	Height	Depth	Color
RV5WBR18CR1	18"	2 13/16"	14"	Chrome
RV5WBR24CR1	24"	2 13/16"	14"	Chrome
RV5WBR30CR1	30"	2 13/16"	14"	Chrome

## Wine and Stemware Rack



Rev-A-Shelf's stemware holders are available in different finishes to organize your collection of stemware and match your kitchen/bar. Constructed of heavy gauge wire and feature a rear mounting plate for either face frame or frameless cabinet construction. Perfect for a kitchen or bar application.



### Stemware Holder

Part Number	Width	Height	Depth	Color
RV315011CR	4 1/4"	1 1/2"	11"	Chrome
RV315011SN	4 1/4"	1 1/2"	11"	Satin Nickel

### Double Bottle Rack

Part Number	Width	Height	Depth	Color
RV3250CR	4 1/4"	9"	5/8"	Chrome
RV3250SN	4 1/4"	9"	5/8"	Satin Nickel

### Quad Stemware Holder

Part Number	Width	Height	Depth	Color
RV345011CR	17"	1 1/2"	11"	Chrome
RV345011SN	17"	1 1/2"	11"	Satin Nickel

### Tray Dividers

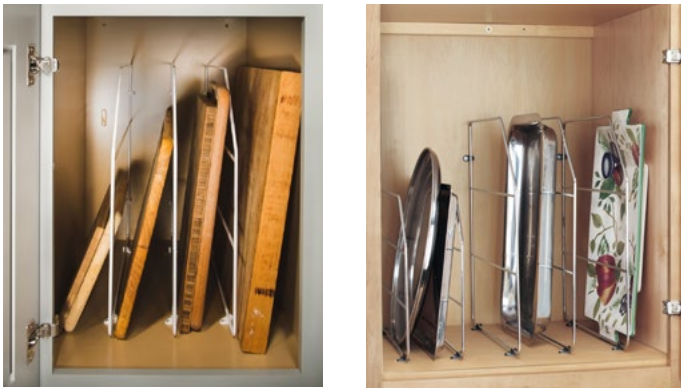

Simple but effective. Why fight with your baking sheets or platters and just organize them. Perfect for those small cabinets either above your refrigerator or the skinny cabinets next to your oven. Simple 4 screw installation.

Part Number	Width	Height	Depth	Color
RV5971210	3/4"	12"	20"	White
RV59712CR10	3/4"	12"	20"	Chrome
RV5971810	3/4"	18"	20"	White
RV59718CR10	3/4"	18"	20"	Chrome

### Adjustable Door Mount Spice Rack



Rev-A-Shelf helps to maintain shelf space and keep spices within reach with our adjustable wood door storage spice rack. Includes (3) bins and are adjustable to any position so they don't interfere with your cabinet shelves. Easy to install and can be configured in any position as your spices change.

Part Number	Width	Height	Depth	Color
RV4ASR15	10 1/8"	25"	4"	Maple
RV4ASR18	13 1/8"	25"	4"	Maple
RV4ASR21	16 1/8"	25"	4"	Maple

### Door Mount Spice Rack



Rev-A-Shelf helps to maintain shelf space and keep spices within reach our wood door storage spice rack. Easy to install and all hardware included.

Convenience Hardware

Part Number	Width	Height	Depth	Color
RV4SR15	10 1/2"	21 1/4"	3 1/8"	Maple
RV4SR18	13 1/2"	21 1/4"	3 1/8"	Maple
RV4SR21	16 1/2"	21 1/4"	3 1/8"	Maple

### Door Storage Tray



Rev-A-Shelf's wood door storage bins are perfect for almost anywhere in your home. On a cabinet door, pantry door, under the sink, or even on a wall. Beautiful wood construction and attractive chrome rails make it a nice piece.

Part Number	Width	Height	Depth	Color
RV4235115	10 3/4"	3 5/8"	4 1/4"	Maple

## Wood Spice Drawer Insert



Convenience  
Hardware

Keep spices conveniently stored in a drawer by the stove with Rev-A-Shelf's Spice Drawer Insert. With a tiered configuration for total organization and easy access, these spice drawer inserts are available in natural maple and walnut. The 4SDI Series can be customized to fit various drawer sizes up to a Base 36".

Part Number	Width	Height	Depth	Color
RV4SDI18	3" - 16"	1 9/16"	5 3/16" - 19 3/4"	Maple
RV4SDI24	3" - 22"	1 9/16"	5 3/16" - 19 3/4"	Maple
RV4SDI361	1" - 33 1/8"	1 3/4"	15 3/4" - 19 3/4"	Maple

## Cut-Out Cutting Board Drawer



If you want a professional kitchen with a prep station, then look no further than Rev-A-Shelf's 4WCCB cut-out cutting board drawer. Available in varying sizes for multiple cabinet applications, this drawer makes clean-up easy.

Part Number	Width	Height	Depth	Color
RV4WCCB18SC1	15"	4 5/16"	21 3/4"	Maple
RV4WCCB419FLSC1	16 1/2"	4 5/16"	21 21/32"	Maple

## Charging Drawer



Charge all your electronics together in one location with Rev-A-Shelf's 4WCDBH Series Charging Drawer System.

Part Number	Width	Height	Depth	Color
RV4WCDB18FL1	16 1/2"	4 5/16"	22 7/16"	Maple
RV4WCDB18SC1	15"	4 5/16"	23 3/4"	Maple

## Combination Knife Holder/Cutting Board Drawer



Conveniently store your cutting board and knives together in one complete drawer system with Rev-A-Shelf's 4KCB Series. Featuring natural maple construction, BLUMOTION soft-close slides and figure 8 door mount brackets. This easy-to-install unit includes a built-in knife organizer, up to (4) storage compartments and a wood cutting board.

Part Number	Width	Height	Depth	Color
RV4KCB18SC1	15"	4 3/8"	22 1/8"	Maple
RV4KCB21SC1	18"	4 3/8"	22 1/8"	Maple
RV4KCB24SC1	21"	4 3/8"	22 1/8"	Maple

### Wood Knife Block Insert



Rev-A-Shelf's unique 4WKB-1 Knife Block Tray Insert is out of the box ready at 18-1/2" x 22" providing 19 slots to store knives and has a separate compartment for other utensils. The unique design provides more storage than a traditional Knife Block and with its simple drop-in installation valuable counter top space is available to use immediately. Made of our classic hardwood with a UV cured clear finish to ensure an acceptable match to any kitchen cabinet and can be trimmed to fit drawers of various widths and lengths.

Part Number	Width	Height	Depth	Color
RV4WKB1	18 1/2"	2 3/8"	22"	Maple

### Wood Utility Knife Insert



Conveniently store all your cutlery, utensil and knives in these unique drawer organizers. Rev-A-Shelf's 4WUTKB Series designed for 36" or smaller base cabinet drawers. This natural maple trim-to-fit insert features drop-in installation and ample space for your utensils, cutlery and knives with up to four static, two adjustable storage compartments and fifteen knife slots.

Part Number	Width	Height	Depth	Color
RV4WUTKB361	33 1/8"	2 7/8"	22"	Maple

### Wood Double Cutlery Insert



Double up your drawer space with Rev-A-Shelf's Two-Tiered drawer. This drawer box comes pre-assembled and ready to install into your existing cabinet drawer opening.

Convenience  
Hardware

Part Number	Width	Height	Depth	Color
RV4WTCD15SC1	12"	4 5/16"	21 3/4"	Maple
RV4WTCD18SC1	15"	4 5/16"	21 3/4"	Maple
RV4WTCD21SC1	18"	4 5/16"	21 3/4"	Maple
RV4WTCD24SC1	21"	4 5/16"	21 3/4"	Maple

### Wood Cutlery Tray Insert



Organize kitchen drawers with Rev-A-Shelf's Wood Cutlery Tray Insert. The 4WCT Series is made of our classic Maple hardwood with a UV cured clear finish to ensure an acceptable match to any kitchen cabinet. This modern day clutter solution requires a simple drop-in installation with two sizes that may be trimmed to fit various drawer sizes.

Part Number	Width	Height	Depth	Color
RV4WCT1	8 3/4" - 14 5/8"	2 7/8"	15 1/2" - 22"	Maple
RV4WCT1SH	8 3/4" - 14 5/8"	2 3/8"	15 1/2" - 22"	Maple
RV4WCT3	14 1/2" - 20 5/8"	2 7/8"	15 1/2" - 22"	Maple
RV4WCT3SH	14 1/2" - 20 5/8"	2 3/8"	15 1/2" - 22"	Maple

## Wood Utensil Tray Insert



Convenience  
Hardware

Conveniently store all your kitchen utensils in one organizer with Rev-A-Shelf's 4WUT Series. Designed for 36" or smaller base cabinet drawers, this trim-to-fit insert features up to eleven large storage compartments and is available in natural maple or walnut construction. With drop-in installation it's never been easier to take your kitchen organization to the next level.

Part Number	Width	Height	Depth	Color
RV4WUT1	8 1/8" - 18 1/2"	2 7/8"	17" - 22"	Maple
RV4WUT1SH	8 1/8" - 18 1/2"	2 3/8"	17" - 22"	Maple
RV4WUT3	12" - 24"	2 7/8"	17 5/8" - 22"	Maple
RV4WUT3SH	12" - 24"	2 3/8"	17 5/8" - 22"	Maple
RV4WUTCT361	33 1/8"	2 7/8"	22"	Maple

## Wood Drawer Divider



Part Number	Width	Height	Depth	Color
RV4WD221	1/2"	2 7/8"	22"	Maple
RV4WD22SH1	1/2"	2 3/8"	22"	Maple
RV4WDKB1	1/2"	2"	22"	Maple

## Polymer Cutlery Tray



Rev-A-Shelf's drawer inserts are the best if you are looking for a custom look. Why settle for a cutlery insert that just drops in your drawer and moves every time you open and close your drawer. Create a custom fit by trimming to your exact size.



Part Number	Width	Height	Depth	Color
RVCT1W52	11 1/2"	2 3/8"	21 1/4"	White
RVCT2W52	14 1/4"	2 3/8"	21 1/4"	White
RVCT3W52	17 1/2"	2 3/8"	21 1/4"	White
RVCT4W52	21 7/8"	2 3/8"	21 1/4"	White

## Polymer Utensil Tray Insert



Rev-A-Shelf's drawer inserts are the best if you are looking for a custom look. Why settle for a utility insert that just drops in your drawer and moves every time you open and close your drawer. Create a custom fit by trimming to your exact size.

Part Number	Width	Height	Depth	Color
RVUT10W52	11 1/2"	2 3/8"	21 1/4"	White
RVUT12W52	14 1/4"	2 3/8"	21 1/4"	White
RVUT15W52	17 1/2"	2 3/8"	21 1/4"	White
RVUT18W52	21 7/8"	2 3/8"	21 1/4"	White



## Slim Tip-Out Trays



Tip-out trays are a must-have for every kitchen and bathroom! Perfect for hiding sponges and scouring pads out of sight yet keeping them easily accessible, the Slim Series is designed to accommodate minimum clearance openings for large sink applications.

Part Number	Width	Height	Depth	Hinge Type Included	Color
RV6541361152	36"	3 15/16"	1 11/16"	Tip Out Hinges	White
RV65413611ETH	36"	3 15/16"	1 11/16"	Euro Tip Out Hinges	White
RV654136SC1150	36"	3 15/16"	1 11/16"	Soft Close Hinges	White
RV654136114	36"	3 15/16"	1 11/16"	Bulk Pack None	White

## Standard Tip-Out Trays

Designed for custom projects, the extruded polymer tip-out/spice tray is available in 36" that can be trimmed to the desired length. This versatile tray includes molded polymer end caps with key-shaped holes for easy removal and cleaning. Simply cut the tray to the desired size, attach the end caps with the adhesive provided and install on the false front panel. Comes with self-holding hinges.

Part Number	Width	Height	Depth	Hinges Included	Color
RV6551361150	36"	3 15/16"	2 7/16"	1 pair Standard	White
RV6551361152	36"	3 15/16"	2 7/16"	2 pair Standard	White
RV655136SL1150	36"	3 15/16"	2 7/16"	1 pair Soft Close	White
RV657136114	36"	3 15/16"	2 7/16"	Bulk Pack None	White

## False Front Ends



False Front Ends with Screws  
Packed 40 per box

Part Number: RVST97114

## Tip-Out Hinges



Part Number	Type
RV65529402204	Standard
RV65529502204	Standard Heavy Duty
RV655297114	Standard with End Caps
RVL022050SC40	Soft Close

Convenience  
Hardware

## Tip-Out Euro Hinge



Part Number: RV6552ETH10

## Stainless Sink Front Tip-Out Trays



Add a little luxury to otherwise wasted space with a stainless steel tip-out tray. Perfect for your kitchen or bathroom.

Part Number	Width	Height	Depth	Color
RV6581135	13"	2 1/8"	3"	Stainless Steel
RV6581165	16"	2 1/8"	3"	Stainless Steel
RV6581255	25"	2 1/8"	3"	Stainless Steel
RV6581285	28"	2 1/8"	3"	Stainless Steel
RV6581315	31"	2 1/8"	3"	Stainless Steel
RV658131SC52	31"	2 1/8"	3"	Stainless Steel with Soft Close Hinges

## Molded Sink Front Tip-Out Trays



Rev-A-Shelf's most popular Sink Front Tip-Out Tray Set, the 6572 Series includes one conventional open tray, one accessory tray with ring holder and soap dish, and 2 pairs of Self-Holding hinges. The 6572 Series is made of high-impact polystyrene and is available in 11" or 14" sizes.

Convenience  
Hardware

Part Number	Width	Height	Depth	Color
RV6572111152	11"	2 1/8"	3 13/16"	White
RV6572141152	14"	2 1/8"	3 13/16"	White

## Polymer Drip Tray



The SBDT is your first line of defense against under sink cabinet damage from minor leaks. The unique design not only protects the bottom of your cabinet by holding water the tray actually funnels excessive water to the front of your cabinet and out onto the floor alerting you of the leak. The series is available in three sizes designed for installation in 30", 36" or 40" sink base cabinet construction. They are easy clean up and resistant to most household chemicals.

Part Number	Width	Height	Depth	Color
RVSBDT3336A1	31 1/2" - 34 1/2"	3/4"	21 1/2" - 23 1/4"	Almond
RVSBDT3336S1	31 1/2" - 34 1/2"	3/4"	21 1/2" - 23 1/4"	Silver
RVSBDT3942A1	37 1/2" - 40 1/2"	3/4"	21 1/2" - 23 3/4"	Almond

## Polymer Vanity Base Drip Tray



The SBVDT is your first line of defense against under sink vanity cabinet damage from minor leaks. The unique design not only protects the bottom of your cabinet by holding water the tray actually funnels excessive water to the front of your cabinet and out onto the floor alerting you of the leak. Designed for installation in NEW 24", 30" and 36" vanity sink base cabinet construction, they can be cut down to fit a 21", 27" or 33" cabinets, and the sleek surface makes for easy clean up.

Part Number	Width	Height	Depth	Color
RVSBVDT2124A1	19 1/2" - 22 1/2"	3/4"	18 1/2" - 20 1/4"	Almond
RVSBVDT2730A1	25 1/2" - 28 1/2"	3/4"	18 1/2" - 20 1/4"	Almond
RVSBVDT3336A1	31 1/2" - 34 1/2"	3/4"	18 1/2" - 20 1/4"	Almond

## Rev-A-Lock Cabinet Security



Introducing the revolutionary peace of mind accessory for any parent or grandparent, the Rev-A-Lock. This security device is one-of-a-kind with powerful magnetic locks. The lock assembly can attach to wood, glass, metal, and particleboard cabinets for a guaranteed safeguard from curious little hands. To open the cabinet, simply hold the magnetic key against the cabinet door to disengage the lock. The RL Series also features an unlocking device that allows a disabling of the lock so cabinets can be opened without the key.



Part Number	Description	Color
RVRL2011	Magnetic Lock Assembly	White
RVRL2021	Magnetic Key	White

## Vanity Outlet Grooming Organizer



Are you tired of a cluttered vanity and unsightly cords everywhere? Then your search is over, Rev-A-Shelf's 445 Series Electric Grooming Pullout is the solution for you. This ideal bathroom cabinetry organizer allows you to store and power curling irons, blow dryers and so much more. Door mountable, it is easy to access, and additional shelves provide storage for other beauty products.

Part Number	Width	Height	Depth	Wood
RV445VBOSC8C	9 9/32"	26 1/8"	19 23/32"	Maple

## Grooming Organizer



Find the ideal bathroom cabinetry organizer with Rev-A-Shelf's 445 Series. Designed for face frame 12" full height vanity cabinets, this grooming pullout organizer features two shelves, two removable stainless steel bins, adjustable rubber bushings, patented door mount brackets with micro-adjustment, natural maple construction, and full-extension, TANDEM, 110 lb. rated slides with BLUMOTION soft-close.

Part Number	Width	Height	Depth	Wood
RV445VCG20SC8	8 7/16"	20 3/8"	19 9/16"	Maple
RV445VCG25SC8	8 7/16"	25 9/16"	19 9/16"	Maple

## Vanity Tiered Organizer



Rev-A-Shelf's vanity organizers are perfect height and depth for most bathroom vanities. Organize all of your bathroom necessities without having to reach in the back of your cabinets. Simple installation and patented door mount kit is included to attach your own cabinet door to the front of the unit for easy 1-step access. The 448-VC is available in both a Vanity Height and Base Height version, and features our patented adjustable door mount brackets that allow up to 5 inches of flexibility for trouble-free installation on any door style.

Convenience  
Hardware

Part Number	Width	Height	Depth	Wood
RV448VC20SC8	8 1/2"	20 3/8"	19 9/16"	Maple
RV448VC25SC8	8 1/2"	25 9/16"	19 9/16"	Maple

## Maple L Shaped Vanity Organizer



Conveniently store items while maximizing your under sink vanity space with Rev-A-Shelf's 441 L-Shaped Organizer. Designed for 24" and 30" vanity sink base cabinets and made of maple dovetail hardwood with a semi-gloss finish, this organizer features a unique reversible frame that can be mounted on the left or right to fit around obtrusive plumbing. It glides on TANDEM, 90 lb. rated slides with BLUMOTION soft-close and includes non-skid vinyl lining and acrylic bins.

Part Number	Width	Height	Depth	Wood
RV44112VSBSC1	8 3/4"	18 7/8"	18 25/32"	Maple
RV44115VSBSC1	11 11/16"	18 7/8"	18 25/32"	Maple



### Vanity Outlet Drawer



Convenience  
Hardware

Make the mess of a cluttered vanity a thing of the past with Rev-A-Shelf's vanity outlet drawer. Store hair dryers and curling irons in one easy to access location and additional compartments are perfect for organizing beauty products. With the integrated outlet you always have a free receptacle to plug items in.

Part Number	Width	Height	Depth	Color
RV4VOD18FLSC1	16 1/2"	8 15/16"	22 1/8"	Maple
RV4VOD18SC1	15"	8 15/16"	20 1/8"	Maple

### Vanity Drawer Organizer Insert



Have you ever wished for a clutter free vanity? With our 4VCOS drawer organizer you can conveniently access and organize everything from cosmetics to cotton balls. This trim-to-fit insert drops-in taking your space from messy to magnificent in just seconds.

Part Number	Width	Height	Depth	Color
RV4VCOS221	21 3/4"	2"	21 1/8"	Maple

### Wood Bottom Mount Hamper



Keep your closet floors clear of clothes with our 4WH Series, featuring natural maple dovetail frame, 1.5 BU white hamper and Rev-A-Motion soft-open/soft-close.

Part Number	Width	Height	Depth	Color
RV4WHRM15DM1	14 1/4"	21"	19 3/4"	Maple
RV4WHVCS21DM1	20 5/16"	21 1/4"	18 11/16"	Maple

### Aluminum Bottom Mount Wire Hamper



Keep clothes off the floor and make laundry less of a chore with the Rev-A-Shelf Double Wire Pullout Hamper. Two machine washable cloth liners fit perfectly in removable wire baskets, held in place by your choice of a silver or white polymer base.

Part Number	Width	Height	Depth	Base Color
RVCH241419RM211	24"	18 7/8"	13 15/16"	White
RVCH241419RM217	24"	18 7/8"	13 15/16"	Gray



## Aluminum Bottom Mount Canvas Hamper



This beautiful pullout hamper is the only one in the industry that features a brushed aluminum frame with Rev-A-Shelf's patented soft-close/soft-open Rev-A-Motion technology. Designed for vanity base 18 cabinets, the removable cloth bag makes laundry simple, and the adjustable door mount brackets ensure a perfect fit every time.

Part Number	Width	Height	Depth	Color
RV519015RM111	14 9/32"	19 11/32"	18 1/16"	White
RV519015RM117	14 9/32"	19 11/32"	18 1/16"	Silver

## Polymer Bottom Mount Hamper



Another option for collecting dirty clothes, the Pullout Wire Hamper is available in four sizes and is easily removable for carrying to the laundry room. The HRV Series features full-extension slides and easy installation with just four screws.

Part Number	Width	Height	Depth	Color
RVHRV1215S	11 7/8"	14 3/4"	18"	White
RVHRV1220S	11 7/8"	19 3/8"	18"	White
RVHRV1520S	14 3/4"	19 3/8"	18"	White
RVHRV1520SCR	14 3/4"	19 3/8"	18"	Chrome

## Polymer Bottom Mount Hamper



Keep dirty clothes from piling on the floor with Rev-A-Shelf's large Pullout Polymer Hamper. The HPRV Series features a shallow 20" depth for vanity applications, full-extension ball bearing slides, 1.5 Bushel capacity and installs with just four screws. Door mount kit sold separately.

Convenience  
Hardware

Part Number	Width	Height	Depth	Color
RVHPRV1520S	14 1/4"	19 3/8"	20"	White
RVHPRV1925S	19 7/8"	24"	14"	White

## Wire Tilt-Out Hamper



Now you can conceal and access laundry in one easy motion with the CTOHB Tilt-Out Hamper. Simply door mount the basket rest to a bottom hinged cabinet for easy one step "Slide-In/Slide-Out" basket removal. The series is available in two sizes and three finishes, stylish chrome, satin nickel and oil rubbed bronze. Each is constructed with durable 6.6 mm wire and feature capacities of 1.7 bushels (55 Quarts) for the 16" wide unit, and 2.3 bushels (74 Quarts) for the large 21" unit. Liners and Tilt-out hardware sold separately.

Part Number	Width	Height	Depth	Color
RVCTOHB161319CR52	15 1/2"	19 3/4"	13 1/2"	Chrome
RVCTOHB211319CR52	20 1/2"	19 3/4"	13 1/2"	Chrome

## Tilt-Out Fabric Hamper



Convenience  
Hardware

Our Hamper Bag keeps laundry out-of-sight and out-of-mind, hiding behind a closed, hinged cabinet hamper door. It is shaped like a basket, but it feels like a tote bag with its fully-lined, woven black fabric and soft mesh side panels. Garment ventilation and viewing are improved with the elegant, matte black steel frame maintaining its slanted rim shape (for clearance of the shelf above the hamper door). Best of all, it's a snap to install and use. Simply lift the bag from its frame using the fold-down handles to carry the contents off for washing. It's that simple.

Part Number	Width	Height	Depth	Color
RVCTOHSL181	16"	19 1/2"	13 1/2"	Black
RVCTOHSL241	21"	19 1/2"	13 1/2"	Black
RVCTOHSL301	27"	19 1/2"	13 1/2"	Black
RVCTOHBSL161419CR1	16"	19 1/2"	13 1/2"	Chrome

## Flap Stay



Got a hinged door in need of swing control? Perfect for hamper doors, the flap stay hardware fastens to both the inside and the adjacent vertical section panel. One flap stay is included with the purchase of a Sidelines by Rev-A-Shelf CTOHS hampers but is not included with any other type of basket purchase.

Flap Stay Chrome  
Part Number: RVCTOHBSLFS1

## Closet Basket Pullouts



The original, Sidelines' patented baskets feature full-extension, ball-bearing slides and are available in several luxury finishes, from chrome to bronze, in a variety of sizes. Optional basket slides permit mounting into fixed cabinet sections for closet, laundry, kitchen or pantry for use like a drawer.

Part Number	Width	Height	Depth	Color
RVCBSL181405BZ3	18"	5 3/8"	14"	Bronze
RVCBSL181405CR3	18"	5 3/8"	14"	Chrome
RVCBSL181405SN3	18"	5 3/8"	14"	Satin Nickel
RVCBSL181410BZ3	18"	10 1/2"	14"	Bronze
RVCBSL181410CR3	18"	10 1/2"	14"	Chrome
RVCBSL181410SN3	18"	10 1/2"	14"	Satin Nickel
RVCBSL181417BZ3	18"	17"	14"	Bronze
RVCBSL181417CR3	18"	17"	14"	Chrome
RVCBSL181417SN3	18"	17"	14"	Satin Nickel
RVCBSL241405BZ3	24"	5 3/8"	14"	Bronze
RVCBSL241405CR3	24"	5 3/8"	14"	Chrome
RVCBSL241405SN3	24"	5 3/8"	14"	Satin Nickel
RVCBSL241410BZ3	24"	10 1/2"	14"	Bronze
RVCBSL241410CR3	24"	10 1/2"	14"	Chrome
RVCBSL241410SN3	24"	10 1/2"	14"	Satin Nickel
RVCBSL241417BZ3	24"	17"	14"	Bronze
RVCBSL241417CR3	24"	17"	14"	Chrome
RVCBSL241417SN3	24"	17"	14"	Satin Nickel
RVCBSL301405BZ3	30"	5 3/8"	14"	Bronze
RVCBSL301405CR3	30"	5 3/8"	14"	Chrome
RVCBSL301405SN3	30"	5 3/8"	14"	Satin Nickel
RVCBSL301410BZ3	30"	10 1/2"	14"	Bronze
RVCBSL301410CR3	30"	10 1/2"	14"	Chrome
RVCBSL301410SN3	30"	10 1/2"	14"	Satin Nickel
RVCBSL301417BZ3	30"	17"	14"	Bronze
RVCBSL301417CR3	30"	17"	14"	Chrome
RVCBSL301417SN3	30"	17"	14"	Satin Nickel



### Pull Down Closet Rod



Rev-A-Shelf's Side Mounted, Pull-Down Closet Rod is available in three sizes and features an adjustable rod length to accommodate various openings depending on model. The telescoping pull-rod can be adjusted to the length that works best for you. It is adjustable from 34" to 50" to accommodate universal design and handicap accessible applications.

Part Number	Width	Height	Depth	Color
RVCPDR1826	21 1/2"-26"	34 3/4" - 49 3/4"	4"	Chrome
RVCPDR2635	26" - 35"	34 3/4" - 49 3/4"	4"	Chrome
RVCPDR3548	35" - 48"	34 3/4" - 49 3/4"	4"	Chrome

### Deluxe Slide Valet Rod



In days of yore (whenever that was) your wardrobe was laid out for you, easy to see. Fast forward and now we have closets stuffed to the gills with outfits. But which one should you wear? The Deluxe Closet Valet Rod helps speed your decision. Our valet rod combines the best of the old days with modern design and technology. Mounted to your closet's side panels, it stays out of view, taking up almost no space when not needed. But when it's time to pack for that cross-country trip or get ready for that "hot date", it slides out on a full-extension, ball-bearing steel slide. Best of all, it matches our other Deluxe Accessories for coordinating your belts, ties or scarves, too.

Part Number	Width	Height	Depth	Color
RVCVRS14BZ1	1 5/32"	3 5/32"	13 25/32"	Bronze
RVCVRS14CR1	1 5/32"	3 5/32"	13 25/32"	Chrome
RVCVRS14SN1	1 5/32"	3 5/32"	13 25/32"	Satin Nickel

### Pop-Out Valet Rod

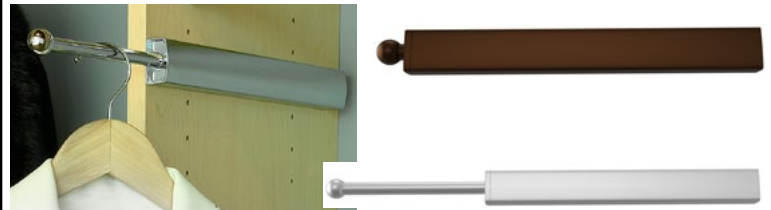

Just back from the laundry or cleaners and need an extra hand putting things away, or are you just tired of hanging one hanger on another just to see what your outfit looks like? Our Pop-Out Telescopic Valet Rod comes to the rescue! The one-touch mechanism pops the rod out when you need it, and a simple push locks it back into its closed position. It holds up to 35 lbs. (perfect for heavy dry cleaning bags) and goes right where you need it: in front of your clothes in the closet. Perfect for next day wardrobe planning, you can even hide it away under a fixed shelf or behind a cabinet door!

Convenience  
Hardware

Part Number	Width	Height	Depth	Color
RVCVLPOSL12CR1	29/32"	1 9/16"	11 25/32"	Chrome
RVCVLPOSL14BZ1	29/32"	1 9/16"	13 3/4"	Bronze
RVCVLPOSL14CR1	29/32"	1 9/16"	13 3/4"	Chrome
RVCVLPOSL14SN1	29/32"	1 9/16"	13 3/4"	Satin Nickel

### Telescoping Valet Rod



Tired of hanging one hanger on another hanger just to see what the outfit looks like? Our Telescopic Valet Rod comes to the rescue! Pull out a suit or a dress and hang it on the rod for your assessment. It holds up to 35 lbs. (perfect for overnight suit bags) and goes right where you need it: in front of your clothes in the closet. Our Telescopic Valet Rod is perfect for next day wardrobe planning, and you can even hide it away under a fixed shelf or behind a cabinet door!

Part Number	Width	Height	Depth	Color
RVCVLSL14BZ1	29/32"	1 9/16"	13 3/4"	Bronze
RVCVLSL14CR1	29/32"	1 9/16"	13 3/4"	Chrome
RVCVLSL14SN1	29/32"	1 9/16"	13 3/4"	Satin Nickel

### Pull-Out Standard Valet



If you are looking for a tie, scarf, valet or belt organizer, Rev-A-Shelf has you covered. Available in different finishes, materials and sizes, surely we will have what you are looking for. One of the most complete closet accessory program around.

Convenience  
Hardware

Part Number	Width	Height	Depth	Color
RVCVL12CR	31/32"	1 5/8"	11 7/8" - 17 7/8"	Chrome

### Pull-Out Designer Valet Rod



If you are looking for a tie, scarf, valet or belt organizer - Rev-A-Shelf has you covered. Available in different finishes, materials and sizes, surely we will have what you are looking for. One of the most complete closet accessory program around.

Part Number	Width	Height	Depth	Color
RVCVR14CR	1 1/8"	1"	13 13/16" - 21 13/16"	Chrome

### Insert Valet Rod



If you are looking for a valet rod that is small and functional - Rev-A-Shelf has you covered. Available in different finishes it installs within the closet panel and extends with just a simple pull.

Part Number	Width	Height	Depth	Color
RVCVRI7CR	5/8"	5/8"	7 19/32" - 7 3/8"	Chrome

Drill Guide for Valet Rod  
Part Number: RVCVR1DG

### Adjustable Laundry Valet Rod



Need a good place to hang your drip-dry laundry? This space-saving, fold-away laundry valet can hold up to 12 or more hangers on its six-hole design. When not in use, simply fold away this wall-mounted rack. Whether you prefer it installed in your laundry room or closet, it provides a great place to stash those just-home-from-the-cleaners dress shirts and other garments before redistributing them to their permanent places in the closet. And if wrinkles are an issue in your house, put one near your dryer to hang up those items that seem to attract wrinkles if not hung up immediately after drying. And if you need an extra clothes-hanging option, it gives you the perfect place to hang up damp coats, jackets and rain gear or a handy instant "closet" for overnight guests' clothing.

Part Number	Width	Height	Depth	Color
RVCLVSLBZ1	2 15/16"	2 15/16"	10 29/32"	Bronze
RVCLVSLCR1	2 15/16"	2 15/16"	10 29/32"	Chrome
RVCLVSLSN1	2 15/16"	2 15/16"	10 29/32"	Satin Nickel

### Pant Rack Pullout



If you've ever tired of paging through an entire array of hangers filled with trousers, we've got the perfect solution to this tedium: The Elite Pants Rack. Our Elite Rack slides out on full-extension, soft-close slides, showing off many pairs of pants at once! With separately-hinged, non-slip, steel hanger arms, it's easy to give your two-legged wardrobe dedicated space in your closet. And don't forget the pantry! This device brings linens and tablecloths to one central location, reducing wrinkles by draping them over hanger arms as long as needed.

Part Number	Width	Height	Depth	Color
RVPCSL1814SCBZ1	18"	2 1/2"	14"	Bronze
RVPCSL1814SCSN1	18"	2 1/2"	14"	Satin Nickel
RVPCSL2414SCBZ1	24"	2 1/2"	14"	Bronze
RVPCSL2414SCSN1	24"	2 1/2"	14"	Satin Nickel
RVPCSL3014SCBZ1	30"	2 1/2"	14"	Bronze
RVPCSL3014SCSN1	30"	2 1/2"	14"	Satin Nickel

## Shoe Rail



Popular as shelf enclosures or shoe guards, Sidelines by Rev-A-Shelf Shoe/Shelf Fences keep items in their place and add style to any closet or pantry. Available in several lengths and finishes, they are designed allowing 1/2" of clearance on each side, making them ideal for slide-out or static shelf applications.

Part Number	Width	Height	Depth	Color
RVCSRSL18BZ10	17"	2"	15/32"	Bronze
RVCSRSL18CR10	17"	2"	15/32"	Chrome
RVCSRSL18SN10	17"	2"	15/32"	Satin Nickel
RVCSRSL24BZ10	23"	2"	15/32"	Bronze
RVCSRSL24CR10	23"	2"	15/32"	Chrome
RVCSRSL24SN10	23"	2"	15/32"	Satin Nickel
RVCSRSL30BZ10	29"	2"	15/32"	Bronze
RVCSRSL30CR10	29"	2"	15/32"	Chrome
RVCSRSL30SN10	29"	2"	15/32"	Satin Nickel
RVCSRSL36BZ10	35"	2"	15/32"	Bronze
RVCSRSL36CR10	35"	2"	15/32"	Chrome
RVCSRSL36SN10	35"	2"	15/32"	Satin Nickel

## Premium Swivel Closet Mirror



The Premier Swivel Closet Mirror is available in two heights and makes space where none exists for a wardrobe mirror. Fastening to a side wall or a panel, our mirror uses only three inches of horizontal storage space, about the same as a stowed ironing board tucked away. When needed, pull out on full-extension, soft-close ball-bearing slides and then swivel ninety degrees to face you. When you are finished viewing, simply pivot it back and give it a nudge to return it to its hiding place.

Part Number	Width	Height	Depth	Color
RVCMSL1448BZ1	2"	47 1/4"	13 3/4"	Bronze
RVCMSL1448SM1	2"	47 1/4"	13 3/4"	Satin Nickel

## Deluxe Pop Out Belt Rack



Want to add the wow factor to your closet, or maybe your range of motion isn't what it use be? Not to worry, our Pop-Out Telescopic Belt Rack comes to the rescue! The one-touch mechanism pops the rack out when you need it, and a simple push locks it back into its closed position.

Convenience  
Hardware

Part Number	Width	Height	Depth	Color
RVBRCPOSL14BZ1	2 1/8"	2 3/16"	13 15/32"	Bronze
RVBRCPOSL14CR1	2 1/8"	2 3/16"	13 15/32"	Chrome
RVBRCPOSL14SN1	2 1/8"	2 3/16"	13 15/32"	Satin Nickel

## Deluxe Slide Belt Rack



Offering easy to reach storage for your belt, the Deluxe Belt Rack complements our other Deluxe Accessories for storage of ties, scarves, and more. It stores against a closet panel and then slides out when needed from behind clothes on full-extension, ball-bearing, steel slides. See your collection of belts on this elegant rack featuring 7 hooks on a steel frame. It is available for 14" or greater depth panels in several luxurious finishes to match Sidelines By Rev-A-Shelf's other accessories.

Part Number	Width	Height	Depth	Color
RVCBRSL14BZ1	2 3/16"	3 7/16"	13 25/32"	Bronze
RVCBRSL14CR1	2 3/16"	3 7/16"	13 25/32"	Chrome
RVCBRSL14SN1	2 3/16"	3 7/16"	13 25/32"	Satin Nickel

## Premier Swivel Belt Rack



Convenience  
Hardware

From sliding to pivoting, the patented Premier Belt Rack is the most sophisticated accessory for belt storage in the 21st century and can be installed and used in the most awkward and unusual locations due to its unique, patented slide out and pivot design. Featuring over-extension, ball-bearing slide, the rack is constructed from steel and cast aluminum. Pull it out and turn it to face you, revealing all your ties at one time. Its exclusive design is available in a variety of Sidelines' most popular finishes to complement your closet's elegant decor. Fits 14" deep or greater closet panels and requires only 4 screws (included) to install in minutes.

Part Number	Width	Height	Depth	Color
RVCSWBRSL14BZ1	2 15/32"	2 1/4"	13 11/16"	Bronze
RVCSWBRSL14CR1	2 15/32"	2 1/4"	13 11/16"	Chrome
RVCSWBRSL14SN1	2 15/32"	2 1/4"	13 11/16"	Satin Nickel

## Side Mount Belt Rack

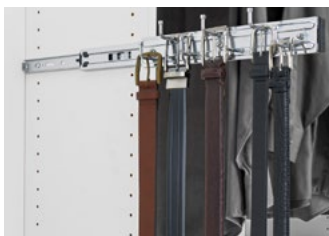

If you are looking for a tie, scarf, valet or belt organizer - Rev-A-Shelf has you covered. Available in different finishes, materials and sizes, surely we will have what you are looking for. One of the most complete closet accessory program around.

Part Number	Width	Height	Depth	Color
RVBRC12CR	2 1/2"	1 7/8"	12"	Chrome
RVBRC14CR	2 1/2"	1 7/8"	14"	Chrome

## Belt/Scarf Organizer

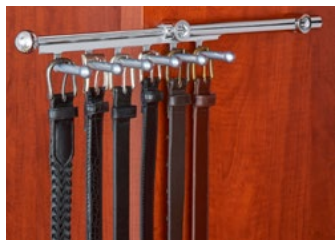

If you are looking for a tie, scarf, valet or belt organizer, Rev-A-Shelf has you covered. Available in different finishes, materials and sizes, surely we will have what you are looking for. One of the most complete closet accessory program around.

Part Number	Width	Height	Depth	Color
RVCBSR14CR	2 3/16"	1 7/8"	13 7/8"	Chrome

## Deluxe Slide Scarf Rack



What better way to mix 'n' match your favorite scarves with coordinating blouses? Sort and select your scarves with ease using our Deluxe Scarf Rack. It is designed to coordinate with our collection of elegant Deluxe Tie, Belt and Valet Racks and has wide loops, positioned on an angle, for easy viewing and storage of scarves. Installed near or adjacent to your blouses, it glides on a full-extension, ball-bearing slide, putting it within easy reach of your main wardrobe but allowing it to hide out of sight when not needed.

Part Number	Width	Height	Depth	Color
RVCSFRSL14CR1	1 25/32"	4 1/8"	13 25/32"	Chrome

## Tie/Scarf Organizer



If you are looking for a tie, scarf, valet or belt organizer, Rev-A-Shelf has you covered. Available in different finishes, materials and sizes, surely we will have what you are looking for. One of the most complete closet accessory program around.

Part Number	Width	Height	Depth	Color
RVCTR14CR	2 13/16"	2 15/16"	13 7/8"	Chrome



### Deluxe Pop-Out Tie Rack



Want to add the wow factor to your closet, or maybe you want the easiest access to your ties? Then look no further than our Pop-Out Telescopic Tie Rack comes to the rescue! The one-touch mechanism pops the rack out when you need it, and a simple push locks it back into its closed position. It holds up to (16) ties and goes right where you need it: in front of your clothes in the closet. Perfect for next day wardrobe planning, you can even hide it away under a fixed shelf or behind a cabinet door!

Part Number	Width	Height	Depth	Color
RVTRCPOSL14BZ1	2 1/4"	2"	13 15/32"	Bronze
RVTRCPOSL14CR1	2 1/4"	2"	13 15/32"	Chrome

### Premier Swivel Tie Rack



From sliding to pivoting, the patented Premier Tie Rack is the most sophisticated accessory for tie storage in the 21st century and can be installed and used in the most awkward and unusual locations due to its unique, patented slide out and pivot design. Featuring over-extension, ball-bearing slide, the rack is constructed from steel and cast aluminum. Pull it out and turn it to face you, revealing all your ties at one time. Its exclusive design is available in a variety of Sidelines' most popular finishes to complement your closet's elegant decor. Fits 14" deep or greater closet panels and requires only 4 screws (included) to install in minutes.

Part Number	Width	Height	Depth	Color
RVCSWTRSL14BZ1	2 9/16"	2"	13 11/16"	Bronze
RVCSWTRSL14CR1	2 9/16"	2"	13 11/16"	Chrome
RVCSWTRSL14SN1	2 9/16"	2"	13 11/16"	Satin Nickel

### Side Mount Tie Racks



If you are looking for a tie, scarf, valet or belt organizer - Rev-A-Shelf has you covered. Available in different finishes, materials and sizes, surely we will have what you are looking for. One of the most complete closet accessory program around.

Convenience  
Hardware

Part Number	Width	Height	Depth	Color
RVTRC12CR	2 1/2"	1 7/8"	12"	Bronze
RVTRC14CR	2 1/2"	1 7/8"	14"	Chrome

### Wall Mount Tie Rack



Want to review all your ties in one, quick glance? The Non-Sliding Tie Rack beautifully organizes all your belts with a simple, elegant design, featuring 16 pegs on a steel frame. It mounts to closet panels or walls with two screws (included) and is available Chrome.

Part Number	Width	Height	Depth	Color
RVTRCSL14NSCR1	1 5/8"	2"	13 15/32"	Chrome



## Elite Rotating Ironing Board



When there's no time to run to the laundry room and dig out the ironing board, Sidelines comes to the rescue! Now there's room for the ironing board right in the closet with your clothes. Shelf

**Convenience Hardware**

mounted, our Elite rotating ironing board is available at a moment's notice to help perfect your days' outfit.

In a snap, you can slide it out and swivel the unit into position. Iron not included!

Part Number	Width	Height	Depth	Color
RVCROIBSL14SM1	18 11/16"	4 17/32"	14"	Silver



Ironing Board Cover  
for Rotating Ironing Board  
Part Number: RVCROIBSLCOVER52

## Premier Pop-Up Ironing Board



Take the strenuous labor out of your ironing with the CPUIBSL Series Pop-Up ironing board that mounts inside of your closet. This ironing board slim design makes it only 6" wide when stored and installs easily into any 14"+ deep closet. Features soft-assist pop-up, metal legs that lock for stability and with overtravel slides, it can be hidden behind a closet door if desired.

Part Number	Width	Height	Depth	Color
RVCPUIBSL14SM1	6 5/16"	43 5/16"	13 15/32"	Silver



Ironing Board Cover  
for Pop-Up Ironing Board  
Part Number: RVCPUIBSLCOVER52

## Deluxe Swivel Ironing Board



When there's no time to run to the laundry room and dig out the ironing board, Sidelines by Rev-A-Shelf comes to the rescue! Now there's room for the ironing board right in the closet with your clothes. Hugging a vertical panel, our space-saving, patented, Deluxe Elite Swivel ironing board is available at a moment's notice to help "perfect" your day's outfit. In a snap you can slide it out, swivel and lower the unit into position. Iron not included! And since every closet space is different, our super-slim ironing board can be swiveled into several positions within a 90-degree radius of its mounting panel. From perpendicular to parallel, adjust it to the position that best suits you!

Part Number	Width	Height	Depth	Color
RVCSWIBSL14SM1	5 1/4"	53 5/32"	13"	Silver



Ironing Board Cover  
for Deluxe Swivel Ironing Board  
Part Number: RVCSWIBSLCOVER52

## Pullout Ironing Board



Rev-A-Shelf has ironed out the inconvenience of storing and setting up that bulky ironing board with the introduction of its CIB Series. The uniquely designed expandable frame mounts easily in a closet between panels and the fixed brackets allow for easy mounting of all standard drawer fronts. It features a chrome finish and a unique ball-bearing slide system that provides sufficient over travel for maximum utilization. Simply open until the gravity lock engages, unfold board and you are ready to iron!

Part Number	Width	Height	Depth	Color
RVCIB16CR	14 1/4" - 21"	4"	15 7/8"	Chrome

## Pull Out Vanity Ironing Board



Rev-A-Shelf has ironed out the inconvenience of storing and setting up that bulky ironing board with the introduction of its VIB Series. The uniquely designed expandable frame mounts easily in a vanity drawer between cabinet sides from 14-1/4" to 21" wide and the fixed brackets allow for easy mounting of all standard drawer fronts. It features a chrome finish and unique ball-bearing slide system that provides sufficient over travel for maximum utilization. Simply open until the gravity lock engages, unfold board and you are ready to iron!

Part Number	Width	Height	Depth	Color
RVVIB20CR	14 1/4"	4"	19 13/16"	Chrome

## Under Mount Jewelry Drawers



Keep your jewelry organized and in meticulous condition with Rev-A-Shelf's CVJD Series Jewelry Drawers. Each system is easily installed with system holes and features soft-close under mount slides and drawer head mounting capability. Used in coordination with the Velvet Ring and acrylic accessories, customization has never been easier. The CVJD features a soft velvet bottom, sturdy wood construction, and drawer front mountable.

Part Number	Width	Height	Depth	Color
RVCVJD2414UM1	24"	3 1/8"	14"	Black
RVCVJD3014UM1	30"	3 1/8"	14"	Black

## Side Mount Jewelry Drawer



Keep your jewelry organized and in meticulous condition with the CJD Series jewelry drawer. The CJD-2414 system is easily installed with system holes and features full-extension ball bearing slides, and drawer head mounting capability.

Used in coordination with the CJD-IS (Jewelry) and CJD-IN (Necklace) inserts customizing and care has never been easier.

Convenience  
Hardware

Part Number	Width	Height	Depth	Color
RVCJD2414	24"	1 7/8"	14"	Black

## Jewelry Drawer Inserts

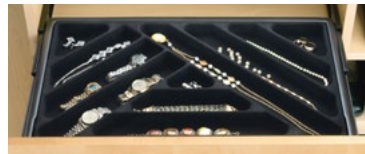

CJD-IN

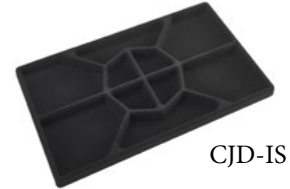

CJD-IS

Part Number	Description	Width	Height	Depth	Color
RVCJD24IN	Necklace Insert	22"	1 1/2"	13"	Black
RVCJD24IS	Jewelry Insert	22"	1 1/2"	13"	Black

## Ring Organizer Jewelry Drawer Inserts



Part Number	Width	Height	Depth	Color
RVCVRING1	11 5/8"	1 1/4"	4 1/4"	Black

## Jewelry Drawer Components

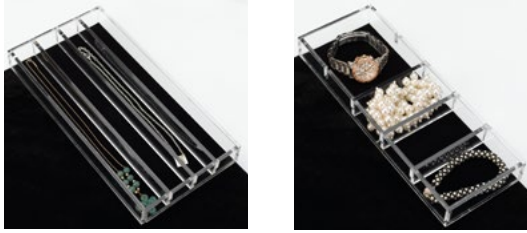

Convenience  
Hardware

Available in a variety of shapes and sizes, our jewelry drawer components provide door mounting options and our insert allow you the freedom to create the perfect organizer for your personal needs.

Part Number	Width	Height	Depth	Color
RVCANECKLACE1	11 5/8"	1 1/4"	6"	Clear
RVCASMORG1	11 5/8"	1 1/4"	4 1/4"	Clear
RVCALGORG1	11 5/8"	1 1/4"	6"	Clear

## 2 Tier File Drawer System



Turn your standard height base 18 drawer/door cabinet into a two-tier file drawer with our file drawer kit. This unique kit features full-extension ball bearing slides and heavy duty chrome plated rails that hold both letter and legal folders. The bottom, side, and rear mounting was designed on the same platform as our successful 5WB2 Series wire baskets. Providing you the sturdiness you expect and easy installation.

Part Number	Width	Height	Depth	Color
RVRASFDKIT	14 3/4"	22 5/8"	24"	Chrome

## Pullout File Drawer System



Designed for 18" base cabinets with a 1-1/2" face frame, the RAS-FDSM-DM15-1 features a chrome-plated frame, door mount brackets, full-extension, ball-bearing slides, and holds either letter or legal sizes.

Part Number	Width	Height	Depth	Color
RVRASFDSDM151	15"	10 1/2"	17 3/4"	Chrome

## File Drawer System

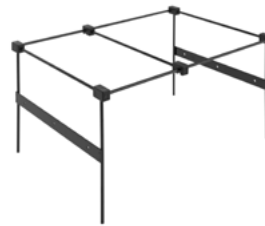

Convert any drawer into an organized file system with Rev-A-Shelf's RAS-SM Series. Designed to easily fit into 18" base cabinet drawers, this organizer features black, powder-coated wire construction and includes T-rod connectors to store legal and letter sizes in one convenient drawer.

Part Number	Width	Height	Depth	Color
RVRASSMFD52	13"	9 3/4"	19 1/4"	Chrome

## Rev-A-Shelf Lighting

### Equiline Puck Lights



With recessed or surface mount ability, EquiLine LED Pucks are perfect for use in a wide range of applications. Designed for the economically conscious, they feature a slim profile and a 79" (2 m) starter cord attached with an unattached AMP connector for easy wire routing.

Included: (1) Light with attached 79" (2 m) Starter Cord and (1) AMP Connector. Surface mount ring sold separately.

Part Number	Watt	Volt	Color Temperature	Color
RVLPOC3EQFRCBL1	3	12	5000K	Black
RVLPOC3EQFRCN11	3	12	5000K	Nickel
RVLPOC3EQFRWBL1	3	12	3000K	Black
RVLPOC3EQFRWN11	3	12	3000K	Nickel

### Equiline LED Surface Ring



Surface Mount Ring for EquiLine Puck lights.  
 Included: (1) Surface Mount Ring

Part Number	Width	Color
RVLSMR2LEDBL1	2.5	Black
RVLSMR2LEDN11	2.5	Nickel

## Power Pockit LED Puck Lights



As the name suggests, this ultra-thin recess or surface mount 3W Pockit provides high output and flooding illumination. The COB diode technology is far superior than tradition surface mount diodes and eliminates any hot spots or pixelated look. No unsightly diodes or reflections from surfaces. A premium choice with several finish options.

Included: (1) Light with attached 79" (2 m) Starter Cord, (1) Surface Mount Ring and (1) AMP Connector.

Part Number	Watt	Volt	Color Temperature	Color
RVLPOC3LEDSFRCCH1	3	12	5000K	Chrome
RVLPOC3LEDSFRCN11	3	12	5000K	Nickel
RVLPOC3LEDSFRWCH1	3	12	3000K	Chrome
RVLPOC3LEDSFRWN11	3	12	3000K	Nickel

## Oval Motion



Slender round Motion Sensor available in Black or Nickel finish. Can be recess or surface mounted. Works with all Tresco 12VDC lights and power supplies. Turns on when human motion is detected. Sensor range is up to 5' (1500mm). Light stays on for ~30 seconds after motion has ceased.  
 Included: (1) Sensor with 79 in. (2 m) input cord and 6 in. (152 mm) output cord attached, and Mounting Hardware.

Oval Motion Sensor  
 Part Number: RVLLEDOVLMSN11



Slender round Touch Dimmer available in Black or Nickel finish. Can be recess or surface mounted. Works with all Tresco 12VDC lights and power supplies. Touch sensor for on/off, hold finger on sensor to cycle through 0-100% dimming control.  
 Included: (1) Dimmer Switch with 79 in. (2 m) input cord and 6 in. (152 mm) output cord attached, and Mounting Hardware.

Oval Touch Dimmer  
 Part Number: RVLLEDOVLTDN11

## Dimmable Power Supply



Hardwire (Dimmable) Power Supply for Tresco 12VDC system. Requires electrician to install.

Included: (1) Power Supply with 6-snap mount block

Part Number	Watt	Volt
RVLDC30DCON1	30	12
RVLDC60DCON1	60	12

## Power Supply



Electronic Plug-In (Non-Dimmable) Power Supplies for Tresco 12VDC system.

Included: (1) Power Supply, (1) 8 ft. (2.4 m) Line Voltage Input Cord, (1) 6-Snap Mounting Block

Part Number	Watt	Volt
RVLDCSLELT301	30	12
RVLDCSLELT601	60	12

## LED Link Cord



12VDC Red/Black multi-use cords with male/female AMP connectors. Cords can be used as starter leads, starter lead extensions or linking cords. Several lengths available. Use is dependent upon lighting system chosen.

Included: (1) Starter/Link/Extension Cord

Part Number	Length	Volt
RVLLEDLINKD1201	48"	12
RVLLEDLINKD1801	72"	12
RVLLEDLINKD2451	96"	12

## Equiline LED Flextape



EquiLine Tape LED is the economical alternative to Tresco's Commercial Grade FlexTape. This 3W/ft. version comes on a 16.4 ft. roll and is cuttable about every inch. Simple "FlexConnect" connection system makes installation a breeze.

Included: (1) Roll

Part Number	Watt	Volt	Length	Color Temperature
RVLTPELED30HER1	3	12	16.4'	3000K
RVLTPELED35HER1	3	12	16.4'	3500K
RVLTPELED48HER1	3	12	16.4'	4800K

## Flextape Jumper Cord



FlexTape link cords with pre-attached screw-on connectors.

Various lengths from 2" - 72".

Included: (1) Link Cord

Part Number	Volt	Length
RVLLEDTPELNK51	12	2"
RVLLEDTPELNK251	12	10"
RVLLEDTPELNK1801	12	72"

## Flextape Starter Cord



2 m (79") FlexTape starter lead with AMP connector and pre-attached screw-on FlexTape connector. Accommodates a single run of FlexTape.

Included: (1) Starter Cord and (1) Wrench.

Flextape Starter

Part Number: RVLLEDTPEPKT2M1

## FineLine LED Linear Light



Pencil thin but still packing a big punch, FineLine is the unobtrusive way to provide stunning lighting to casework, displays, store fixtures and more. The low-profile design features a milk diffuser for even illumination, Luniform technology, and with optional manual or remote-control dimmers, creating the perfect atmosphere is effortless.

Included: (1) Light Fixture, (1) 79" (2 m) Starter Cord, (1) AMP Connector and Mounting U-Clips.

Part Number	Watts per Foot	Volt	Length	Color Temperature	Color
RVLSTKHO8CNI1	4.40	12	8"	5000K	Nickel
RVLSTKHO8WNI1	4.40	12	8"	3000K	Nickel
RVLSTKHO12CNI1	4.40	12	12"	5000K	Nickel
RVLSTKHO12WNI1	4.40	12	12"	3000K	Nickel
RVLSTKHO22CNI1	4.40	12	22"	5000K	Nickel
RVLSTKHO22WNI1	4.40	12	22"	3000K	Nickel
RVLSTKHO34CNI1	4.40	12	34"	5000K	Nickel
RVLSTKHO34WNI1	4.40	12	34"	3000K	Nickel

## Stick LED Link Cord



FineLine link cords with pre-attached male/female connections. Various lengths from 2" - 72".

Included: (1) Link Cord

Part Number	Volt	Length
RVLLEDSTKLNK251	12	10"
RVLLEDSTKLNK1201	12	48"
RVLLEDSTKLNK1801	12	72"

## Transformer Amp Mount Block



12VDC Black add-on mounting block accommodates up to 6 fixtures. Multiple mounting blocks can be used on one power supply not to exceed 60W maximum load.

Included: (1) 6-Snap Mounting Block

Part Number	Volt	Color
RVLTRANSMNTBL1	12	Black

## Wireless Dimmer Receiver



Tresco Lighting brings simplicity to your low voltage LED systems. Nowhere is this more evident than our new FREEDiM Series Universal Receiver. This Receiver connects between Tresco's Universal 12/24VDC Power Supply and any of our dimmable LED lights, then gets synced up with any of the four new FREEDiM Series Wireless Controller options (Deco Wall Dimmer, Micro Dimmer, and 3/6-Zone Remotes). One touch pairing makes programming your Controller and Receiver quick and easy. 60W Capacity (12VDC); 96W Capacity (24VDC) meaning they can handle the full load of Tresco's largest 12/24VDC Power Supplies.

Included: (1) Receiver

Part Number	Color
RVLWLD1REC1	White

## FREEDiM Series Micro Dimmer



Love the convenience of remote dimmers but can't seem to keep track of yours? Try our new low profile, wireless FREEDiM Series Micro Dimmer. The mounting case comes with an integrated magnet for mounting to metallic surfaces, or can be screw mounted to any wood surface as well. With smooth dimming, a simple one-button control, and the freedom to place it anywhere with 65 feet of the Universal Receiver, the Micro truly is a game-changing addition to the Tresco offering.

Included: (1) Dimmer



A single dimmer can be programmed to up to 10 different receivers.

A single receiver can be programmed to up to 8 different FREEDiM Series remotes/dimmers.

Must purchase 12VDC to 24VDC Controller Adapter Cord set for 24VDC LED fixtures.

Part Number	Color
RVLWLD1RNDBL1	Black
RVLWLD1RNDNI1	Nickel

### FREEDiM Series Deco Wall Dimmer



The FREEDiM Series Deco Wall Dimmer's innovative, patent-pending design combines the convenience and flexibility of a remote dimmer with the style and functionality of a traditional hardwired switch. Designed to fit standard electrical boxes and Decora style wall plates, this groundbreaking new wireless technology will drastically reduce materials and labor costs without sacrificing quality or style. Included: (1) Wall Dimmer

A single dimmer can be programmed to up to 10 different receivers.

A single receiver can be programmed to up to 8 different FREEDiM Series remotes/dimmers.

Part Number	# of Zones	Color
RVLWLD1WALWH1	1	White
RVLWLD2WALWH1	2	White

### FREEDiM Series 3-Zone Remote Dimmer



Take control of multiple lighting zones without having to keep track of multiple remotes or wall switches with our new FREEDiM Series 3-Zone Remote Dimmer. Set the ambiance levels you want, and store them as scenes to be recalled later with only the touch of a button. Included: (1) Dimmer and (1) Magnetic Docking Tray

A single receiver can be programmed to up to 8 different FREEDiM series remotes/dimmers.

Part Number	Color
RVLWLD3RMTBL1	Black

### Wireless Door Sensor Receiver



60W Capacity (12VDC); 96W Capacity (24VDC). Install between power supply and lights with simple one button pairing with FREEDiM Series Wireless Door Sensors. Included: (1) Receiver, (1) set of 24V Adapter Cords.

Single receiver can be programmed with up to (4) sensors allowing up to 4 doors to control the same light fixtures.

Part Number	Input Voltage	Color
RVLWLSREC1	12/24 VDC	White

### FREEDiM Wireless Door Sensors



Allows light to be controlled by multiple doors with up to (4) sensors paired to a single receiver. No cumbersome, messy wires to have to hide inside your cabinetry. Included: (1) Sensor, (2) screws, (1) double-stick adhesive and (3) stick-on magnet covers.

Part Number	Color
RVLWLSDBL1	Black
RVLWLSN11	Nickel

### Infinex Diffusers



Clear Diffuser for use with any Infinex extrusion profiles. Easily cuttable and snaps in/out of extrusion channel, providing protection from LEDs without reducing light output.  
 Frosted Diffuser for use with any Infinex extrusion profiles. Provides a softer light with less glare and uniform intensity and light output.  
 Milk/Opal Diffuser lens for use with any Infinex extrusion profiles. Eliminates LED hot spot diode reflection on reflective surfaces and provides a soft, uniform light output.  
 Included: (1) Diffuser

Part Number	Length	Lens
RVLX72DIFFCL1	72"	Clear
RVLX72DIFFFR1	72"	Frosted
RVLX72DIFFMLK1	72"	Milk



## Infinex Angled Extrusion



Infinex is the innovative, patented, LED aluminum extrusion system by Tresco Lighting. Gone are the days of set fixture sizes, simply choose your style, cut to desired length and assemble to create a customized LED fixture. Designed by our in-house engineers and made in the USA, Infinex carries a UL safety certification and is available in six profiles with an array of installation options. Infinex is designed for easy DIY application. We also offer prefabricated custom solutions with a minimum quantity order. Angled Infinex is for corner mounting with screws only. Fixture directs light at a 30-degree angle and uses Infinex specific starter leads. End caps, starter cords, LED FlexTape and power supplies sold separately. Simple DIY assembly & installation.

Included: (1) Extrusion

Part Number	Length	Color
RVLXANG72SC1	72"	Satin Nickel

### Angled Infinex End Cap Set

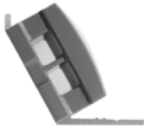

Set of 2 end caps for Angled Infinex extrusions.

Included: (2) End Caps  
Gray

Part Number: RVLXANGECPGY

## Infinex Curved Extrusion



Infinex is the innovative, patented, LED aluminum extrusion system by Tresco Lighting. Gone are the days of set fixture sizes, simply choose your style, cut to desired length and assemble to create a customized LED fixture. Designed by our in-house engineers and made in the USA, Infinex carries a UL safety certification and is available in six profiles with an array of installation options. Infinex is designed for easy DIY application. We also offer prefabricated custom solutions with a minimum quantity order. Can be mounted using U-Clips, Magnets, or screws. Mounting accessories, end caps, starter cords, LED FlexTape and power supplies sold separately. Simple DIY assembly & installation.

Included: (1) Curved Extrusion and mounting screws.

Part Number	Length	Color
RVLXCRV72SC1	72"	Satin Nickel

### Curved Infinex End Cap Set



Set of 2 end caps for Curved Infinex extrusions.

Included: (2) End Caps  
Gray

Part Number: RVLXCRVECPGY1



## Infinex Flush Extrusion



Infinex is the innovative, patented, LED aluminum extrusion system by Tresco Lighting. Gone are the days of set fixture sizes, simply choose your style, cut to desired length and assemble to create a customized LED fixture. Designed by our in-house engineers and made in the USA, Infinex carries a UL safety certification and is available in six profiles with an array of installation options. Infinex is designed for easy DIY application. We also offer prefabricated custom solutions with a minimum quantity order. Designed for channels that go the entire width or height of the casework. Starter cords, LED FlexTape and Power Supplies sold separately. Simple DIY assembly & installation.

Included: (1) Flush Extrusion with unattached milk diffuser.

Part Number	Length	Color
RVLXFL72SC1	72"	Satin Nickel
RVLXFL96SC1	96"	Satin Nickel

## Infinex Linking Cord



Linking Cords of various lengths and wire colors for connecting multiple Infinex fixtures.

Included: (1) Male AMP Link Cord, (1) Female AMP Link Cord, (1) wrench and VHB tape.

Part Number	Volt	Length	Color
RVLXLNK15BL1	12	6"	Black
RVLXLNK15WH1	12	6"	White

## Infinex Linking Cord



12VDC 79" (2 m) Starter Cord, Black, for Square, Curved, Round and Angled Infinex.

Included: (1) Starter Cord

Part Number	Volt	Length	Color
RVLXPKT2MBL1	12	79"	Black
RVLXPKT2MWH1	12	79"	White

## Infinex Recessed Extrusion



Infinex is the innovative, patented, LED aluminum extrusion system by Tresco Lighting. Gone are the days of set fixture sizes, simply choose your style, cut to desired length and assemble to create a customized LED fixture. Designed by our in-house engineers and made in the USA, Infinex carries a UL safety certification and is available in six profiles with an array of installation options. Infinex is designed for easy DIY application. We also offer prefabricated custom solutions with a minimum quantity order. Grooved sides allow extrusion to pressure fit into place. End caps, starter cords, LED FlexTape and power supplies sold separately. Simple DIY assembly & installation.

Included: (1) Recessed Extrusion

Part Number	Length	Color
RVLXREC72SC1	72"	Satin Nickel

## Recessed Infinex End Cap Set



Set of 2 end caps for Recessed Infinex extrusions.

Included: (2) End Caps  
Gray

Part Number: RVLXRECECPGY1

## Infinex Round Extrusion



Infinex is the innovative, patented, LED aluminum extrusion system by Tresco Lighting. Gone are the days of set fixture sizes, simply choose your style, cut to desired length and assemble to create a customized LED fixture. Designed by our in-house engineers and made in the USA, Infinex carries a UL safety certification and is available in six profiles with an array of installation options. Infinex is designed for easy DIY application. We also offer prefabricated custom solutions with a minimum quantity order. U-clip mounting allows fixture to be rotated in 15-degree increments either direction. U-Clips, End caps, starter cords, LED FlexTape and power supplies sold separately. Simple DIY assembly & installation.  
 Included: (1) Round Extrusion

Part Number	Length	Color
RVLXRND72SC1	72"	Satin Nickel

### Round Infinex End Cap Set



Set of 2 end caps for Round Infinex extrusions.  
 Included: (2) End Caps  
 Gray

Part Number: RVLXRNDECPGY1

### Round Infinex Extrusion U-Clips



Set of 2 U-Clips for Round Infinex extrusions.  
 Included: (2) Mounting U-Clips  
 Gray

Part Number: RVLXRNDUCLP1

## Infinex Square Extrusion



Infinex is the innovative, patented, LED aluminum extrusion system by Tresco Lighting. Gone are the days of set fixture sizes, simply choose your style, cut to desired length and assemble to create a customized LED fixture. Designed by our in-house engineers and made in the USA, Infinex carries a UL safety certification and is available in six profiles with an array of installation options. Infinex is designed for easy DIY application. We also offer prefabricated custom solutions with a minimum quantity order. Surface mount using magnets, U-clips or screws. Mounting accessories, end caps, starter cords, LED FlexTape and power supplies sold separately. Simple DIY assembly & installation.  
 Included: (1) Square Extrusion

Part Number	Length	Color
RVLXSQR72SC1	72"	Satin Nickel

### Square Infinex End Cap Set



Set of 2 end caps for Square Infinex extrusions.  
 Included: (2) End Caps  
 Gray

Part Number: RVLXSQRECPGY1

### Square/Curved Infinex Swivel Clip Set



Need to control the direction of the beam angle for your Square or Curved Infinex fixture? These Swivel Clips will do the trick.

Included: (2) Mounting Swivel Clips  
 Gray

Part Number: RVLXSQRSWCLP1

### Square/Curved Infinex U-Clip Set



Set of 2 U-Clips for Square or Curved Infinex extrusions.

Included: (2) Mounting Clips  
 Gray

Part Number: RVLXSQRUCLP1

**Trash Bin Pull-Out - Vibo**



Door brackets included. The waste containers are equipped with handles to easily keep your nylon bag inside and lift cans up. Can be bottom mounted or side mounted. Lids sold separately.

Part Number	Height	Width	Depth	Quart Size	# of Bins
65PAM12135C	19 1/2"	12"	19 5/8"	35	1
65PAM15228C	19 1/2"	15"	19 5/8"	32	2
65PAM15250CR	24 1/16"	15"	22"	50	2
65PAM18228C	19 1/2"	18"	19 5/8"	32	2
65PAM21235C	19 1/2"	21"	19 5/8"	35	2



32 Quart Replacement Bin  
Depth: 14 3/8"  
Width: 8 5/8"  
Height: 18 7/64"  
Color: Gray

Part Number: 65PAM128C

**Under Sink Trash Bin Pull-Out - Vibo**



12" Under the sink waste bins. Soft close, wire bottom, full extension. The waste bins are equipped with handles to easily keep your trash bag inside and lift cans up. Bottom mount.

Part Number	Height	Width	Depth	Quart Size	# of Bins
65PETAM332MC	15 1/16"	11 3/4"	19 5/8"	16	2

**Import Trash Can Pull Out Unit**



3D adjustable. With full extension ball bearing slides. Bottom mount. Trash bins and door mounting brackets sold separately.

Part Number	Height	Width	Depth	Quart Size	# of Bins*
PR70BBSGL35PC	19 1/2"	12"	18"	35	1
PR70BBDBL35PC	19 1/2"	15"	22"	35	2

\* Trash bins sold separately, see below.



35 Quart Bin for Trash Pull Out Units  
Color: Gray

Part Number: PR70TC35GR



Door Mounting Bracket for Trash Pull Out Units  
Packed 20 sets per Box.

Part Number: PR70BRKT





**Omega National**  
PRODUCTS  
Super Susans

This select series susan is indeed the highest quality, best operating wood lazy susan available. Super susans are pre-mounted on the patent-pending diecast aluminum bearing for ultra smooth movement, 450 lb weight capacity and features a high-impact 10 ply maple rim and 12mm multi-directional plywood shelf.

**Kidney**



Part Number	Size	Lip	Wood
OMT8228K30TRDCBMNL1	28" Kidney	1 3/4"	Maple
OMT8332K30TRDCBMNL1	32" Kidney	1 3/4"	Maple

**Import Full Round Lazy Susan**



Part Number	Mount	Post Height	Diameter	# of Shelves	Color
PRLS18RDW	Top/Bottom	25 1/2" - 31 1/2"	18"	2	White
PRLS24RDW	Top/Bottom	25 1/2" - 31 1/2"	24"	2	White

**Import Kidney Lazy Susan**



Part Number	Mount	Post Height	Diameter	# of Shelves	Color
PRLS24KDW	Top/Bottom	25 1/2" - 31 1/2"	24"	2	White
PRLS28KDW	Top/Bottom	25 1/2" - 31 1/2"	28"	2	White
PRLS32KDW	Top/Bottom	25 1/2" - 31 1/2"	32"	2	White

Convenience Hardware



**2 - Shelf Pivoting Fly Moon - Vibo**



The shelves can be pulled-out independently, trays are designed to increase storage surface, height adjustable shaft, easy to install: the mechanism is a patented system and can be easily fixed in on one side of the cabinet, non slip melamine surface, for frame and frameless cabinets. Load capacity 44 lbs per shelf. Minimum door opening 85 degrees, height of shelf rail 2 3/4".

←Left hand shown.

Part Number	Height	Width	Depth	Color	Hand
65QFLY40SXG2OMVCH	3 3/8"	29"	16 1/32"	Maple Champagne	Left
65QFLY40DXG2OMVCH	3 3/8"	29"	16 1/32"	Maple Champagne	Right
65QFLY45SXG2OMVCH	3 3/8"	32 3/16"	17 3/8"	Maple Champagne	Left
65QFLY45DXG2OMVCH	3 3/8"	32 3/16"	17 3/8"	Maple Champagne	Right
65QFLY60SXG2OMVCH	3 3/8"	38 7/16"	18 3/4"	Maple Champagne	Left
65QFLY60DXG2OMVCH	3 3/8"	38 7/16"	18 3/4"	Maple Champagne	Right



Fly Moon Mechanism - Vibo



Convenience Hardware

Left hand shown.  
For use with Fly Moon shown on previous page.

Part Number	Height	Color	Hand
65QFLYANEM2SXVGF	26" - 32"	Champagne	Left
65QFLYANEM2DXVGF	26" - 32"	Champagne	Right



Corner Organizer



Set Includes:  
1 Frame Set  
(Inner Cabinet  
Dimensions)  
540mm H x  
860-968mm W  
x 490mm D

2 MA11 Wire  
Basket 89mm H  
x 263mm W  
x 436mm D

2 MA12 Wire  
Basket 88mm H  
x 378mm W  
x 455mm D

The unique design allows full use of corner cabinets.  
The item can be assembled for left and right hand.  
Door mount hardware makes for easy installation.  
Frame mounted to full extension heavy duty slide.  
Adjustable basket locations.  
Soft-Close.  
Minimum cabinet opening: 356mm  
Door width: 400-450mm  
Load capacity: Side Frame 15kg/33lbs  
Load capacity: Inner Frame 20kg/44lbs  
Steel chrome plated.

Part Number: FUJASMH111A

Spice Holder Pull-Out - Vibo



Minimum opening 6", 2-tier base organizer, full extension soft close, non slip melamine surface, for frame and frameless cabinets. Load capacity 75 lbs. 3-way door adjustment, comes fully assembled ready to be installed.

Stocked in American Maple and Champagne finish. Available in White and Chrome finish.

Kit contents: 2-tier side pull-out unit, full extension soft close slide, adjustable door-mounting bracket, assembly instructions and drilling template.

Part Number	Width	Height	Depth	Handed	Wood
65ELQAM6DXOMVCH	5 3/4"	21"	21 3/8"	Right	Maple
65ELQAM6SXOMVCH	5 3/4"	21"	21 3/8"	Left	Maple



### Spice Holder Pull-Out - Vibo



Minimum opening 4 1/2", 3-tier base organizer, full extension soft close, non slip melamine surface, for frame and frameless cabinets. Load capacity 75 lbs. 3-way door adjustment, comes fully assembled ready to be installed.

Stocked in American Maple and Champagne finish. Available in White and Chrome finish.

Kit contents: 3-tier side pull-out unit, full extension soft close slide, 2 adjustable door-mounting bracket, assembly instructions and drilling template.

Part Number	Width	Height	Depth	Handed	Wood
65ELQAM4DXOMVCH	4 1/4"	22 5/8"	21 3/8"	Right	Maple
65ELQAM4SXOMVCH	4 1/4"	22 5/8"	21 3/8"	Left	Maple

### Rotating Pantry Unit - Vibo



Available full set heights  
46 7/32" - 91 3/32"

There are different bracket and basket combinations available. Please contact U.S. Industrial Fasteners for more information.

### Tray Divider



Divides base cabinets and pantry units, mounts to base of cabinet with welded clips. Sold Individually.

Part Number	Height	Tray Depth	Finish
FUTDC12	12"	18"	Chrome
FUTDC18	18"	18"	Chrome

Convenience  
Hardware



### Omega National PRODUCTS

### Spice Drawer Insert



Wood spice drawer insert is designed for storage of all types of spice jars. Produced from Baltic Birch plywood finished with a durable UV coating. Each insert is easily trimmed to desired size. Boxed individually.

Part Number	Size	Wood
OMSDI1910	10" x 19 1/2"	Baltic Birch
OMSDI1913	13" x 19 1/2"	Baltic Birch
OMSDI1916	16" x 19 1/2"	Baltic Birch
OMSDI1919	19" x 19 1/2"	Baltic Birch



# Omega National PRODUCTS

## Stemware Rack Moulding



Convenience Hardware

Solid wood, fully sanded and ready to finish. 62" lengths in both profiles allow custom installation for applications.

Part Number	Description	Wood	Box Quantity
OMM4600QUF2	62" "L" Stemware Rack Moulding	Alder	12
OMM4600CUF2	62" "L" Stemware Rack Moulding	Cherry	12
OMM4600MUF2	62" "L" Stemware Rack Moulding	Maple	12

Part Number	Description	Wood	Box Quantity
OMM4640QUF2	62" "T" Stemware Rack Moulding	Alder	12
OMM4640CUF2	62" "T" Stemware Rack Moulding	Cherry	12
OMM4640MUF2	62" "T" Stemware Rack Moulding	Maple	12

## Standard Wine Racks



Panels are produced from sturdy mouldings 3/4" wide and 7/16" thick with radiused edges. Bottle openings are 4" x 4". Routed face for custom look. Easily cut to desired size. Boxed two pieces per carton.

17" x 36" - 14 full bottle openings  
24" x 30" - 18 full bottle openings

Part Number	Size	Wood
OMWRL1736AL	17" x 36"	Alder
OMWRL1736MA	17" x 36"	Maple
OMWRL2430AL	24" x 30"	Alder
OMWRL2430MA	24" x 30"	Maple



# Omega National PRODUCTS

## Tambour Doors



SW15



SW30



V3

## Wood Veneer Tambour Doors

Wood veneer bonded to medium density fiberboard with a balance veneer, then bonded to cloth backer for functional stability and performance. Sanded and ready to finish.

Part Number	Size	Wood
OMV3AL501	47 1/2" x 36"	Alder
OMV3MA501	47 1/2" x 36"	Maple
OMV3RO502	47 1/2" x 36"	Red Oak

## Solid Wood Tambour Doors

Individual solid hardwood slat mouldings bonded to a cloth backer. Sanded and ready to finish.

Part Number	Size	Type	Wood
OMSW30MA508	47" x 36"	Thick, Flat Style	Maple

## Spring Tension Track Systems - Face Frame

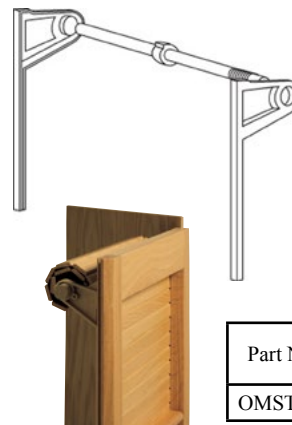

System includes tension spring, wood dowel, donut(s) and plastic guide rails for Tambour Doors up to 36" wide x 19" high x .22" thick. Dowels can be trimmed for narrower widths. Door is easily controlled from top to bottom, glides smoothly. Easily stapled to back of face frame.

Part Number	Size	Color	Box Quantity
OMST216AL	16" x 17 1/2"	Almond	10 pair



# Omega National PRODUCTS

## PVC Track Systems Flush Mounting

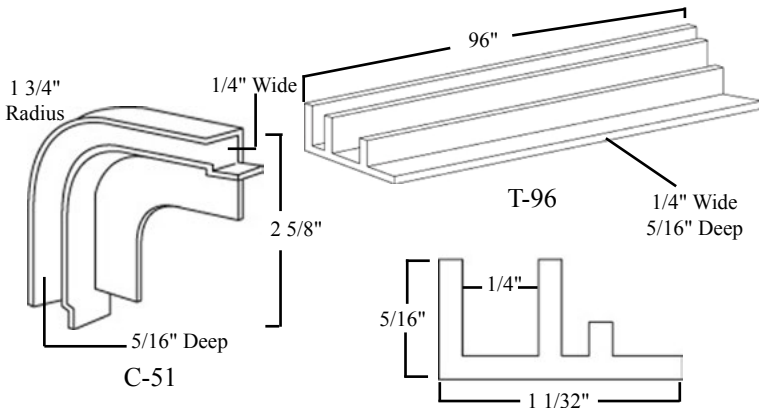

Designed for flush mounting. Combine T-96 straight sections with C-51 corners to accommodate almost any size tambour door of 3/16" thickness. Thicker tambour doors must be tenoned. Can be fastened with 3/8" staples or pan head type screws.

Part Number	Description	Color	Box Quantity
OMC51BR	Corner Tambour Flush Mount Track	Brown	50
OMT96BR	Straight Flush Mount Track	Brown	30

## Recessed Mounting

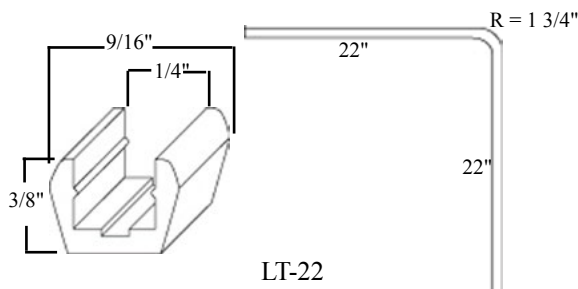

A self-lubricating track system for most any tambour door style, thickness or size. Rigid extruded PVC. Easily cut to desired lengths. Track can be recessed in routed 3/8" deep x 9/16" wide groove or stapled directly to end panels. Smooth operation, no sticking. Maximum tambour thickness of 7/32"; thicker tambours must be tenoned.

Part Number	Description	Color	Box Quantity
OMLT22BR	L-Shaped Flush Mount Track	Brown	30
OMLT22WH	L-Shaped Flush Mount Track	White	30



# Omega National PRODUCTS

## Range Hoods



Manufactured from solid wood and wood veneers. Includes assembled galley rail and white 24 gauge liner, this hood is an inexpensive way to offer a custom look. Designed for use with Omega Series Power Modules.

Available by  
Special Order.

Convenience  
Hardware

Part Number	Description	Wood
OMR1130CUF1	30" Range Hood	Cherry
OMR1130MUF1	30" Range Hood	Maple
OMR1136CUF1	36" Range Hood	Cherry
OMR1136MUF1	36" Range Hood	Maple

## Ventilator Power Modules

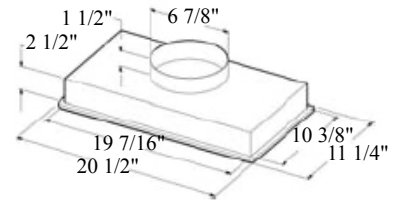

Part Number	Description	Color
OMRHVBF10SM	250 CFM Two Speed Fans	Silver

## Support Brackets



Part Number	Size	Wood	Box Quantity
OMS1102CUF2	8" x 6" Support Bracket	Cherry	2
OMS1102MUF2	8" x 6" Support Bracket	Maple	2
OMS1102QUF2	8" x 6" Support Bracket	Alder	2
OMS1101CUF2	10" x 8" Support Bracket	Cherry	2
OMS1101MUF2	10" x 8" Support Bracket	Maple	2
OMS1101QUF2	10" x 8" Support Bracket	Alder	2





# Omega National

PRODUCTS

## Column Concepts



Mix and match the column products to create your own designs. Choose a cap and base and simply add one of the half rounds.

Create filler designs, corner detail or add to existing moulding packages.

Wood Adornments

### Triangle Block



Part Number	Description	Wood	Box Quantity
OMM2311CUF2	10" Triangle Block	Cherry	2
OMM2311MUF2	10" Triangle Block	Maple	2

### Split Cap



Part Number	Description	Wood	Box Quantity
OMB5210MUF2	1.5" Split Cap	Maple	4

### Split Spindle Cap



Part Number	Description	Wood	Box Quantity
OMB5100MUF2	2.5" x 3" Split Spindle Cap	Maple	4

### Split Spindle Cap



Part Number	Description	Wood	Box Quantity
OMB5120CUF2	2.156" x 3" Split Spindle Cap	Cherry	4
OMB5120MUF2	2.156" x 3" Split Spindle Cap	Maple	4



# Omega National

PRODUCTS

## Columns



### Fluted Column



Part Number	Description	Wood	Box Quantity
OMM2283CUF2	36" Fluted Column	Cherry	2
OMM2283MUF2	36" Fluted Column	Maple	2

### Beaded Column



Part Number	Description	Wood	Box Quantity
OMM2293CUF2	36" Beaded Column	Cherry	2
OMM2293MUF2	36" Beaded Column	Maple	2

### Plain Column



Part Number	Description	Wood	Box Quantity
OMM2303CUF2	36" Plain Column	Cherry	2
OMM2303MUF2	36" Plain Column	Maple	2

### Split Rope Column



Part Number	Description	Wood	Box Quantity
OMM0043CUF2	48" Split Rope Column	Cherry	2
OMM0043MUF2	48" Split Rope Column	Maple	2





# Omega National

PRODUCTS

## Split Rope Moulding



Every piece of rope moulding is sanded by hand and blemish-free to ensure superior workmanship and 100% yield.

Part Number	Description	Wood	Box Quantity
OMM0050CUF2	3/8" x 3/16" x 96"	Cherry	25
OMM0050MUF2	3/8" x 3/16" x 96"	Maple	25
OMM0051CUF2	1/2" x 7/32" x 96"	Cherry	25
OMM0052CUF2	3/4" x 5/16" x 96"	Cherry	25
OMM0052MUF2	3/4" x 5/16" x 96"	Maple	25
OMM0040CUF2	1" x 7/16" x 96"	Cherry	25
OMM0044MUF2	1 1/2" x 11/16" x 96"	Maple	25

## Dentil Moulding



Hand sanded and blemish-free to ensure superior craftsmanship and 100% yield.

Part Number	Description	Wood	Box Quantity
OMM8398CUF2	5/8" x 1/4" x 96"	Cherry	25
OMM8398MUF2	5/8" x 1/4" x 96"	Maple	25

## Crown Moulding



No splices, no blemishes, 100% yield from each piece.

Part Number	Description	Wood	Box Quantity
OMM0491CUF2	4.09" x .8125" x 96"	Cherry	12
OMM0491MUF2	4.09" x .8125" x 96"	Maple	12
OMM0491QUF2	4.09" x .8125" x 96"	Alder	12



# Omega National

PRODUCTS

## Beaded/Fluted Fillers Unfinished



Simply the best reversible moulding on the market. Designed for either beaded or fluted applications, one moulding makes it simple and economical. Moulded from high quality lumber, this moulding is even offered with beaded/fluted rosettes for a completely finished look.

Beaded Side

Fluted Side

Wood Adornments



Part Number	Description	Wood	Box Quantity
OMM4311CUF2	3" x 31 1/2"	Cherry	2
OMM4311HUF2	3" x 31 1/2"	Hickory	2
OMM4311MUF2	3" x 31 1/2"	Maple	2
OMM4312HUF2	3" x 48"	Hickory	2
OMM4312MUF2	3" x 48"	Maple	2

## Beaded/Fluted Rosettes Unfinished



Part Number	Description	Wood	Box Quantity
OMR8111MUF2	3" x 3" Cove Edge for Fluted	Maple	6

Part Number	Description	Wood	Box Quantity
OMR8171CUF2	3" x 3" Cove Edge for Beaded	Cherry	6
OMR8171HUF2	3" x 3" Cove Edge for Beaded	Hickory	6
OMR8171MUF2	3" x 3" Cove Edge for Beaded	Maple	6

Part Number	Description	Wood	Box Quantity
OMR8185OUF2	3" x 3" Without Edge for Beaded	Red Oak	6



# White River



White River Products are available by special order.  
Please contact U.S. Industrial for more information.

## Wood Adornments

## Import Wooden Products



**PRCORBG**  
Grape Corbel  
Available in Small, Medium and Large.  
Alder or Rubberwood



**PRCORBT**  
Traditional Corbel  
Available in Small, Medium and Large.  
Cherry, Maple, Red Oak, Alder or Rubberwood



**PRCORBA2**  
Acanthus Corbel  
Available in Small, Medium and Large.  
Maple, Alder or Rubberwood



**PRONLAY1**  
Hand Carved Onlay  
Available in Small, Medium, and Large.  
Cherry, Maple, Red Oak, Alder, or Rubberwood



**PRONLAY2**  
Hand Carved Onlay  
Available in Small, Medium, and Large.  
Maple, Red Oak, Alder, or Rubberwood



**PRCORBB**  
Classic Corbel  
Available in Various Sizes.  
Cherry, Maple, Red Oak, Alder or Rubberwood



**PRCORBA6-Low Profile**  
Low Profile Acanthus Corbel  
Available in Various Sizes.  
Cherry, Maple, Red Oak, Alder or Rubberwood



**PRCORBM**  
Mission Corbel - 2 Styles  
Available in Small, Medium and Large.  
Cherry, Maple, Red Oak, Alder or Rubberwood



**PRBUNN4**  
Crown Bunn Foot 5" x 3"  
Alder or Rubberwood



**PRBUNN1**  
Bunn Foot 5" x 3"  
Maple, Alder, or Rubberwood



**PRBUNN2**  
Turned Bunn Foot 4" x 4"  
Maple, Red Oak, Alder, or Rubberwood



**PRLEG6**  
Traditional Queen Anne Leg  
4" x 4" x 6"  
Maple, Alder, or Rubberwood



## Import Wooden Posts

Sold Individually

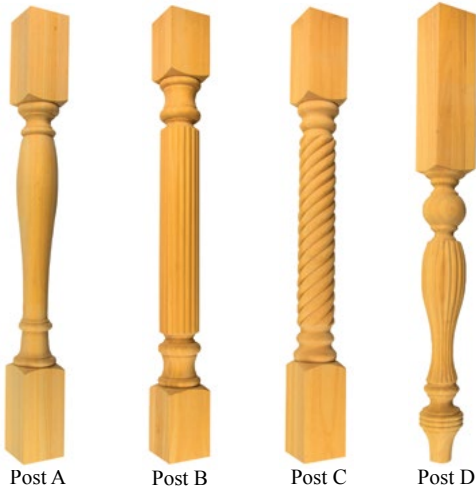

Part Number	Post	Post Size	Finish
PRPOSTAALD	A	3 1/2" x 3 1/2" x 35 1/4"	Alder
PRPOSTAMPL	A	3 1/2" x 3 1/2" x 35 1/4"	Maple
PRPOSTBALD	B	3 1/2" x 3 1/2" x 35 1/4"	Alder
PRPOSTBMPL	B	3 1/2" x 3 1/2" x 35 1/4"	Maple
PRPOSTCALD	C	3 1/2" x 3 1/2" x 35 1/4"	Alder
PRPOSTCMPL	C	3 1/2" x 3 1/2" x 35 1/4"	Maple
PRPOSTDALD	D	3 1/2" x 3 1/2" x 35 1/4"	Alder
PRPOSTDMPL	D	3 1/2" x 3 1/2" x 35 1/4"	Maple

\*\* 5" x 5" x 36" Posts are available please contact U.S. Industrial for more information.

\*\* Half Legs are available please contact U.S. Industrial for more information.

## Table Legs



80mm Diameter x 710mm Length,  
30mm plus adjustment in foot.  
Packed 6 legs per Box

Black Part Number: 7104T110BK

## "H" Table Legs



"H" Table Leg - Black  
27 1/2" Total Length  
Packed 4 per Box

Wood  
Adornments

Black Part Number: 7104TH30BK

\*1/4-20 Leveler Sold Separately

## Table Legs

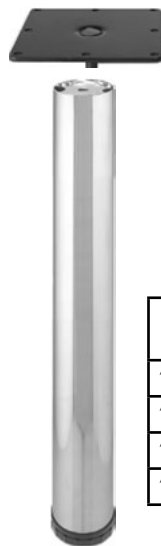

Leg screws into steel square mounting plate.  
Static load rating: approximately 220 lbs per leg.  
Adjustment range +25mm.  
Plastic levelers are pressed in, they can be removed and pounded back in if legs need to be cut.  
Set includes 4 legs, 4 mounting plates and screws #9 x 1".  
Mounting plate color: black.

Part Number	Width	Length	Leg Color	Box Quantity
7363561377	60mm	710mm	Black	1 set
7363561475	60mm	710mm	Brushed Steel	1 set
7363553372	76mm	710mm	Black	1 set
7363553471	76mm	710mm	Brushed Steel	1 set

## Import Barn Door Hardware

### Flat Rail Surface Mount



Steel with powder coat or  
Stainless Steel.  
Max. Door Weight: 350 lbs  
Suitable for door thickness of  
1 1/4" - 1 3/4"  
(35-45mm)



Set Includes:  
\* 5 Clamps for Fixing Track  
\* 2 Door Stoppers  
\* 1 Rail, Length 6.5' or 8'  
\* 2 Anti Jump Blocks  
\* 2 Sliding Door Rollers  
\* 1 Floor Guide  
\* Screws and Allen Key

#### Barn Door Hardware

Part Number	Length	Finish	Box Quantity
FU7721451005	6.5'	Steel Matte Black	1 set
FU7721453007	6.5'	Steel Oil Rubbed Bronze	1 set
FU7721456006	6.5'	Stainless Steel	1 set
FU7721451020	8'	Steel Matte Black	1 set
FU7721453021	8'	Steel Oil Rubbed Bronze	1 set
FU7721456023	8'	Stainless Steel	1 set

### Flat Rail Top Mount

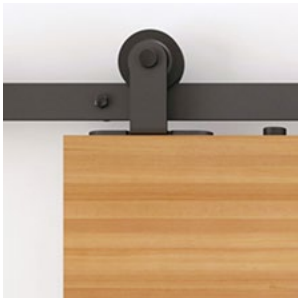

Steel with powder coat or  
Stainless Steel.  
Max. Door Weight: 350 lbs  
Suitable for door thickness of  
1 3/16" - 1 3/4" (30-45mm)



Set Includes:  
\* 5 Clamps for Fixing Track  
\* 2 Door Stoppers  
\* 1 Rail, Length 6.5' or 8'  
\* 2 Anti Jump Blocks  
\* 2 Sliding Door Rollers  
\* 1 Floor Guide  
\* Screws and Allen Key

Part Number	Length	Finish	Box Quantity
FU7722451008	6.5'	Steel Matte Black	1 set
FU7722456009	6.5'	Stainless Steel	1 set
FU7722451024	8'	Steel Matte Black	1 set
FU7722456025	8'	Stainless Steel	1 set

## Import Barn Door Hardware

### Round Rail Surface Mount

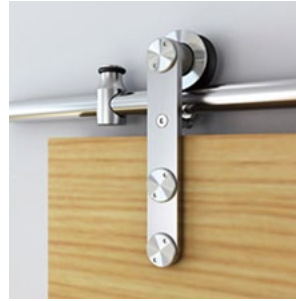

Stainless Steel  
Max. Door Weight: 260 lbs  
Suitable for door thickness of 1 3/8" - 1 9/16"  
(35-40mm) Soft Close 1 3/8" - 1 3/4" (35-45mm)



Surface Mount  
Hardware Kit with  
Soft Close Includes:  
\* 4 Clamps for Fixing Track  
\* 2 Door Stops  
\* 1 Rail, Length 6.5'  
\* 2 End Caps  
\* 2 Soft Close Mechanisms  
\* 2 Triggers for Soft Close  
\* 2 Sliding Door Rollers  
\* 1 Floor Guide  
\* Screws and Mounting Tool

Surface Mount Hardware Kit  
Includes:  
\* 4 Clamps for Fixing Track  
\* 2 Door Stoppers  
\* 1 Rail, Length 6.5'  
\* 2 End Caps  
\* 2 Sliding Door Rollers  
\* 1 Floor Guide  
\* Screws and Mounting Tool

Part Number: FU7711456001

Part Number: FU7711356002

### Handles for Barn Door Hardware

Handles for barn door hardware are available by special order.  
Please contact us for more information.

## Import Barn Door Hardware

### Round Rail Top Mount

Stainless Steel

Max. Door Weight: 260 lbs

Suitable for door thickness of 1 3/8" - 1 9/16"

(35-40mm) Soft Close 1 3/8" - 1 3/4" (35-45mm)

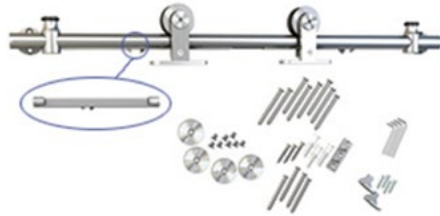

Top Mount Hardware Kit with Soft Close Includes:

- \* 4 Clamps for Fixing Track
- \* 2 Door Stops
- \* 1 Rail, Length 6.5'
- \* 2 End Caps
- \* 2 Soft Close Mechanisms
- \* 2 Triggers for Soft Close
- \* 2 Sliding Door Rollers
- \* 1 Floor Guide
- \* Screws and Mounting Tool

Part Number: FU7712356004



Top Mount Hardware Kit Includes:

- \* 4 Clamps for Fixing Track
- \* 2 Door Stoppers
- \* 1 Rail, Length 6.5'
- \* 2 End Caps
- \* 2 Sliding Door Rollers
- \* 1 Floor Guide
- \* Screws and Mounting Tool

Part Number: FU7712456003

## Import Barn Door Hardware

### Mini Flat Rail Surface Mount

Steel with powder coat.

Max. Door Weight: 44 lbs

Suitable for door thickness of 1" - 1 3/16" (25-30mm)

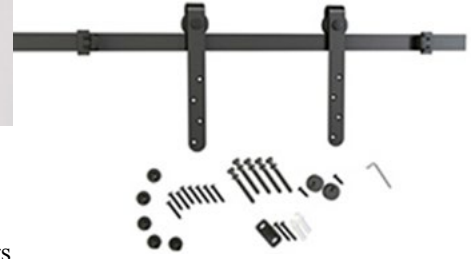

Kit Includes:

- \* 2 Door Stoppers
  - \* 1 Rail, Length 5' 10"
  - \* 2 Anti Jump Blocks
  - \* 2 Sliding Door Rollers
  - \* 1 Floor Guide
  - \* Screws and Mounting Tool
- Steel Matte Black Finish

Part Number: FU7721451010

Barn Door  
Hardware

### Mini Flat Rail Top Mount

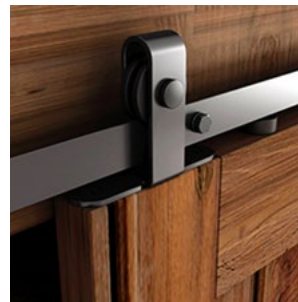

Steel with powder coat.

Max. Door Weight: 44 lbs

Suitable for door thickness of 1" - 1 3/4" (25-45mm)



Kit Includes:

- \* 2 Door Stoppers
  - \* 1 Rail, Length 5' 10"
  - \* 2 Anti Jump Blocks
  - \* 2 Sliding Door Rollers
  - \* 1 Floor Guide
  - \* Screws and Mounting Tool
- Steel Matte Black Finish

Part Number: FU7722451011

## Import Barn Door Hardware

### Soft Close Mechanism for Flat Rail



Max Load of 176 lbs  
Overall Dimensions:  
13-3/8" x 15/16" x 13/16"

Part Number	Finish	Box Quantity
FU7725351100	Steel Matte Black	1 set
FU7725356109	Stainless Steel	1 set

### Latches for Barn Door Hardware

Barn Door Hardware



Part Number	Finish	Box Quantity
FU7751951201	Matte Black	1
FU7751953202	Oil Rubbed Bronze	1
FU7751959200	Stainless Steel	1

### Rail Connectors



For Round Rail  
Stainless Steel  
Part Number: FU7715956107



Stainless Steel  
Part Number: FU7715956123



For Flat Rail

Part Number	Finish	Box Quantity
FU7725951104	Matte Black	1
FU7725953106	Oil Rubbed Bronze	1
FU7725956105	Stainless Steel	1

## Import Barn Door Hardware

### Guides and Door Brackets

#### C Guide



Part Number	Finish	Box Quantity
FU7791951110	Matte Black	1
FU7791953111	Oil Rubbed Bronze	1
FU7791956112	Stainless Steel	1

#### T Guide



Part Number	Finish	Box Quantity
FU7791951113	Matte Black	1
FU7791953114	Oil Rubbed Bronze	1
FU7791956115	Stainless Steel	1

#### Bypass Door Bracket



Part Number	Finish	Box Quantity
FU7791951101	Matte Black	1
FU7791953103	Oil Rubbed Bronze	1
FU7791956102	Stainless Steel	1



## Salice Pocket Door System

Pocket Door System is available by special order, please contact U.S. Industrial for more information.



## Salice Bortoluzzi

Bortoluzzi items are custom made and special order items, please contact U.S. Industrial for assistance in ordering.

Closet  
Hardware

### Mover System

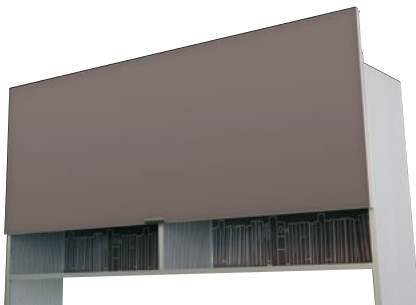

- \* Vertical sliding system for a wall (upper) cabinet only.
- \* Door Height Options = 480mm (18 inches) or 600mm (23 inches) only
- \* Door Width Options based on Door Width (LA) = 900mm (35 inches), 1200mm (47 inches), 1800mm (70 inches), 2400mm (94 inches) only.
- \* Maximum Door Weight = 13 lbs - 50 lbs

### Slider M50+ System

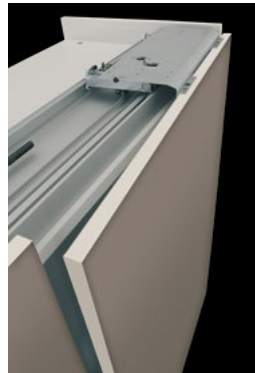

- \* Sliding system for a floor cabinet.
- \* Maximum Door Height for tracks up to 1500mm = 2200mm (86 inches).
- \* Maximum Door Height for tracks 1600mm-4000mm = 3000mm (118 inches).
- \* Door Width = Min. 60mm (23 5/8 inches) Max. 2000mm (78 3/4 inches).
- \* Maximum Door Thickness with Handle = 45mm (1.7 inches).
- \* Maximum Door Weight = 50kg (110 lbs).
- \* Doors can be made of wood, glass (aluminum frame), or clipper doors. The minimum profile width for aluminum doors = 2 inches.
- \* The clipper doors are only available on track lengths of 1600mm-3000mm.
- \* Width of the track is based on the internal dimension of the cabinet.
- \* There is more flexibility in building your cabinet with this system. On the smaller sizes (1200-1500), the tracks are in increments of 100, so you can fall anywhere between. On the larger sizes (1600-4000), the tracks are in increments of 200, so you can have a custom size cabinet but you do not need a custom length track.





Bortoluzzi items are custom made and special order items, please contact U.S. Industrial for assistance in ordering.

## Slider L70 System



- \* Sliding system for a floor cabinet available for 2 door or 3 door units Type 33.
- \* Maximum Door Height = 3000mm (118 inches).
- \* Door Width = Min. 800mm (31 inches) Max. 2000mm (78 inches).
- \* Maximum Door Thickness with Handle = 45mm (1.7 inches).
- \* Maximum Door Weight = 70kg (154 lbs).
- \* Doors can be made of wood, glass (aluminum frame), or clipper doors. The minimum profile width for aluminum doors = 2 1/2 inches.
- \* The clipper doors can be used as long as you are within the weight parameters. Max door size is 1500mm x 2650mm.
- \* Width of the track is based on the internal dimension of the cabinet.
- \* There is more flexibility in building your cabinet with this system. The tracks are in increments of 200, so you can have a custom size cabinet but you do not need a custom length track.

Closet  
Hardware

## Slider S



- \* Sliding system for two-door wall units with decelerated opening and closing.
- \* Maximum Door Height: 47 1/4 inches
- \* Door Thickness: Minimum 1 3/4 inches
- \* Maximum Thickness of the Door with Handle: 1 49/64 inches
- \* Maximum Door Load: 48 1/2 lbs
- \* Door Width = Min. 23 5/8 inches Max. 59 inches
- \* Vertical Door Adjustment: +/- 3/64 inch
- \* Horizontal Door Adjustment: +/- 1/8 inch
- \* Upper load-bearing track fitted to the top panel of wall unit.
- \* Lower track recessed into the base panel of the wall unit.



## Closet Rod

### Round Closet Rod



Part Number	Diameter	Length	Finish	Packed Per Box
FURO1116CP8	1 1/16"	8'	Chrome	10
FURO1116CP12	1 1/16"	12'	Chrome	10
FURO1516DC8	1 5/16"	8'	Brushed Chrome	10
FURO1516OB8	1 5/16"	8'	Oil Rubbed Bronze	20

### Oval Closet Rod



Part Number	Length	Length Inches	Finish	Packed Per Box
631011466	2400 mm	8'	Chrome	10
63101146612	3600 mm	12'	Chrome	10
631011466B	2400 mm	8'	Brass	10
631011466DC	2400 mm	8'	Brushed Chrome	10
631011466BLK	2400 mm	8'	Matte Black	20
631011466ORB	2400 mm	8'	Oil Rubbed Bronze	20

### Round Closet Rod Fittings



Part Number	Diameter	Type	Finish	Packed Per Box
FU83320CP	1 1/16"	Closed Screw On	Chrome	50
FU83340CP	1 1/16"	Open Screw On	Chrome	50
FU83345CP	1 1/16"	Open Dowel	Chrome	50
FU83311DC	1 5/16"	Closed Dowel	Brushed Chrome	20
FU83311ORB	1 5/16"	Closed Dowel	Oil Rubbed Bronze	100
FU83351DC	1 5/16"	Open Dowel	Brushed Chrome	20
FU83351ORB	1 5/16"	Open Dowel	Oil Rubbed Bronze	100

\*\*Closet Rod and Sockets are also available for special order in Brass, Nickel, Matte Black, and Oil Rubbed Bronze.\*\*

## Closet Rod Fittings

### Oval Closet Rod Fittings



Screw On      Dowel      Center Mount

Part Number	Type	Finish	Packed Per Box
631005791	Screw On	Chrome	100
631005792	Dowel	Chrome	100
631005791B	Screw On	Brass	100
631005792B	Dowel	Brass	100
631005792BLK	Dowel	Matte Black	100
631005791DC	Screw On	Brushed Chrome	100
631005792DC	Dowel	Brushed Chrome	100
631005791ORB	Screw On	Oil Rubbed Bronze	500
631005792ORB	Dowel	Oil Rubbed Bronze	500
7380203201	Center Mount	Chrome	100

Closet Hardware

## Oval Shelf & Rod Bracket



For oval 15mm x 30mm rod.  
11" L x 10 3/4" H.  
Steel construction.  
Polished Chrome  
Packed 20 per Box

Part Number: EP848PC

## Closet Sockets

### Hardwood



For 1 3/8" Rod  
Packed 50 Pair per Box

Part Number: 71526019

## Suspension Rail



8' length  
Steel  
25 pieces per bundle  
Part Number: GR499830001719

## Suspension Rail Cover



8' length  
Plastic

Part Number	Length	Color	Box Quantity
GR499831000153	8'	Almond	50
GR499831000162	8'	Black	50
GR499831000158	8'	Brown	50
GR499831000174	8'	White	50

Closet  
Hardware

## Suspension Brackets



Steel  
286 lbs carrying capacity per wall cabinet  
200 pieces per box  
Left Hand Part Number: GR499825401215  
Right Hand Part Number: GR499825401115

## Suspension Bracket Covers



Part Number	Hand	Color	Box Quantity
GR514825401253	Left	Almond	200
GR514825401262	Left	Black	200
GR514825401258	Left	Brown	200
GR514825401274	Left	White	200



Part Number	Hand	Color	Box Quantity
GR514825401153	Right	Almond	200
GR514825401162	Right	Black	200
GR514825401158	Right	Brown	200
GR514825401174	Right	White	200

**Titus**  
Fittings for purpose

Titus



19mm Camfix Non-outrigger  
2,500 pieces per box  
Black Part Number: 6706387LA  
Brown Part Number: 6706387CL  
White Part Number: 6706387WA



16mm Camfix Non-outrigger  
2,500 pieces per box  
Black Part Number: 6706383LA  
Brown Part Number: 6706383CL  
White Part Number: 6706383WA



Quickfit Dowel  
5mm x 12mm  
5,000 pieces per box  
Part Number: 6706408YA

## Coat Hook



Double Coat Hook  
Polished Chrome  
Packed 50 per Box

Part Number: PRCH8363PC

## Coat Hook



Double Coat Hook  
Packed 50 per Box

Matte Black  
Part Number: PRCH81160MB

Polished Chrome  
Part Number: PRCH81160PC



## Adjustable Round Closet Rod



An ideal, sturdy, adjustable rod for closets. Exceeds ANSI/BHMA A156.16 deflection standards when installed with center support(s). Escutcheons are swaged and staked to tubes to provide double pull away protection. Comes with screws for installation

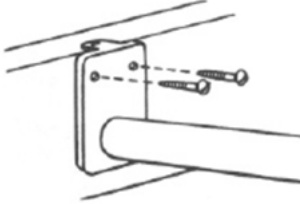

Part Number	Width	Packed Per Box
KVKV2BPZC18	18" to 30"	10
KVKV2BPZC30	30" to 48"	10

## 12 1/2 Foot Aluminum Sliding Track



12 1/2' Track  
Packed 10 per Box  
Part Number: 73AV800



Carrier with Top Plate  
Packed 10 per Box  
Part Number: 73AV802

## Sliding Panel Track 3/4" - Plastic - EpcO

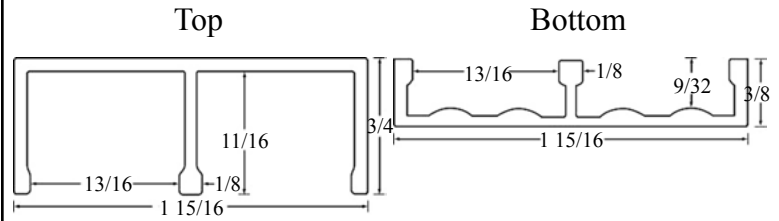

High impact extruded polystyrene plastic track.  
Stocked in light gray, 12 foot lengths.  
Each Packed 30 per Box

Top Part Number: EP2234GY  
Bottom Part Number: EP234GY

## Shelf Standard (Pilasters)

Recess or surface mount with staples, screws, or nails.

Closet Hardware  
/Shelf Standard



Length	Part Number	Color	Packed Per Box
24"	71160120024BS	Brass	100
24"	71160120024SZ	Steel Zinc	100
48"	71160120048SZ	Steel Zinc	100
60"	71160120060SZ	Steel Zinc	100
72"	71160120072SZ	Steel Zinc	50
96"	71160120096SZ	Steel Zinc	50
#256 Clip	KV256ZC	Zinc	1,000

## Import Shelf Standards and Brackets



Length	Part Number	Box Quantity
24"	TEB0159241174	10
36"	TEB0159361174	10
48"	TEB0159481174	10
72"	TEB0159721174	10
84"	TEB0159841174	10



Length	Part Number	Box Quantity
12"	TEB0153121224	10
14"	TEB0153141224	10
16"	TEB0153161224	10
18"	TEB0153181224	10
20"	TEB0153201224	10
22"	TEB0153221224	10
24"	TEB0153241224	10

Shelf Standard  
/Brackets

## Heavy Duty Store Equipment - Reeve



### Universal Line Standards

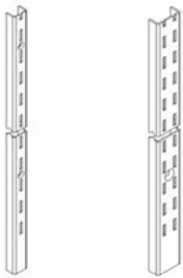

Universal Line  
RE40

Universal Line  
RE44

Length	Single Slot #40	Double Slot #44	Box Quantity
2'	RE402		10
3'	RE403	RE443	10
4'	RE404	RE444	10
5'	RE405	RE445	10
6'	RE406	RE446	10
7'	RE407	RE447	10
8'	RE408	RE448	10

Use #7 Screw    Use #10 Screw

## Heavy Duty Store Equipment - Reeve



### Universal Line Brackets



Universal Line  
RE41

Length	#41	Box Quantity
8"	RE418	24
10"	RE4110	24
12"	RE4112	24
14"	RE4114	24
16"	RE4116	24
18"	RE4118	24
20"	RE4120	24

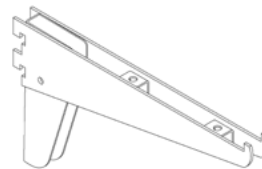

Universal Line  
RE485

Length	#485	Box Quantity
8"	RE4858	10
10"	RE48510	10
12"	RE48512	10
14"	RE48514	10
16"	RE48516	10
18"	RE48518	10
20"	RE48520	10



Universal Line  
RE81

Length	#81 Left	#81 Right	Box Quantity
8"		RE81R8	12
10"	RE81L10	RE81R10	12
12"	RE81L12	RE81R12	12
14"	RE81L14	RE81R14	12
16"	RE81L16	RE81R16	12
18"	RE81L18	RE81R18	12

### Slatwall Hardware

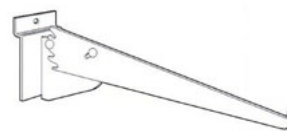

RE93

Length	#93	Box Quantity
8"	RE938	12
10"	RE9310	12
12"	RE9312	12
14"	RE9314	12
16"	RE9316	12



## Heavy Duty Store Equipment - Reeve



### 700 Line Heavy Duty Standards



700 Line Heavy Duty  
RE700

Use #14 Screw.

Length	Single Slot #700	Box Quantity
4'	RE7004	10
5'	RE7005	10
6'	RE7006	10
8'	RE7008	10

### 700 Line Heavy Duty Brackets

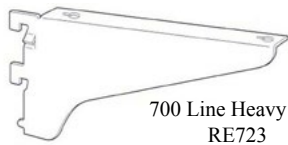

700 Line Heavy Duty  
RE723

Length	#723 Left	#723 Right	Box Quantity
10"	RE723L10	RE723R10	12
12"	RE723L12	RE723R12	12
14"	RE723L14	RE723R14	12
16"	RE723L16	RE723R16	12
18"	RE723L18	RE723R18	12



700 Line Heavy Duty  
RE766

Length	#766	Box Quantity
8"	RE7668	12
10"	RE76610	12
12"	RE76612	12
14"	RE76614	12
16"	RE76616	12
18"	RE76618	12
20"	RE76620	12
22"	RE76622	12



700 Line Heavy Duty  
RE767

Length	#767	Box Quantity
10"	RE76710	24
12"	RE76712	24
14"	RE76714	24
16"	RE76716	12
18"	RE76718	12

## Heavy Duty Store Equipment - Reeve



### Miscellaneous Accessories

#### Top Cap For Standard



Packed 100 per Box  
Part Number: RE49T

#### Footpiece For Standard

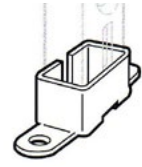

Packed 100 per Box  
Part Number: RE49B

#### Shelf Rests



Left  
Packed 100 per Box  
Part Number: RE743L

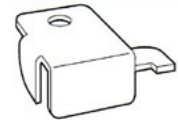

Right  
Packed 100 per Box  
Part Number: RE743R



Center  
With Rubber Cushion  
Packed 100 per Box  
Part Number: RE743

Shelf Standard  
/Brackets



Rubber Cushion  
Grey  
Part Number: RE4

### Shelf Bracket



Heavy duty L bracket supports up to 1,000 lbs per pair, perfect for workbenches, countertops, or shelving applications in stores and warehouses.

Stocked in white, available in black.

Size	Part Number	Color	Box Quantity
12"	KV208WH300	White	10
16"	KV208WH400	White	10
20"	KV208WH500	White	10
22"	KV208WH550	White	10

## Support Brackets



1/8" Steel exceeds 1,000 lbs load limit.  
1 1/2" forms with multiple 1/4" mounting holes per side.  
Packaged in equal quantities of rights and lefts.  
Brackets are reversible.

The 12" and larger sizes have a 3" x 3" - 45 degree notch that allows for wall cleat and wire run clearance.

Part Number	Size	Color	Pieces per Box
AH5X8AL	5" x 8"	Almond	10
AH5X8BL	5" x 8"	Black	10
AH5X8GY	5" x 8"	Gray	10
AH5X8WH	5" x 8"	White	10
AH8X12AL	8" x 12"	Almond	10
AH8X12BL	8" x 12"	Black	10
AH8X12GY	8" x 12"	Gray	10
AH8X12WH	8" x 12"	White	10
AH12X18AL	12" x 18"	Almond	6
AH12X18BL	12" x 18"	Black	6
AH12X18GY	12" x 18"	Gray	6
AH12X18WH	12" x 18"	White	6
AH15X21AL	15" x 21"	Almond	6
AH15X21BL	15" x 21"	Black	6
AH15X21GY	15" x 21"	Gray	6
AH15X21WH	15" x 21"	White	6
AH18X24AL	18" x 24"	Almond	6
AH18X24BL	18" x 24"	Black	6
AH18X24GY	18" x 24"	Gray	6
AH18X24WH	18" x 24"	White	6
AH24X24AL	24" x 24"	Almond	6
AH24X24BL	24" x 24"	Black	6
AH24X24GY	24" x 24"	Gray	6
AH24X24WH	24" x 24"	White	6
AH24X29AL	24" x 29"	Almond	4
AH24X29BL	24" x 29"	Black	4
AH24X29GY	24" x 29"	Gray	4
AH24X29WH	24" x 29"	White	4

Brackets & Extrusions

## ADA Toe Kick Bracket

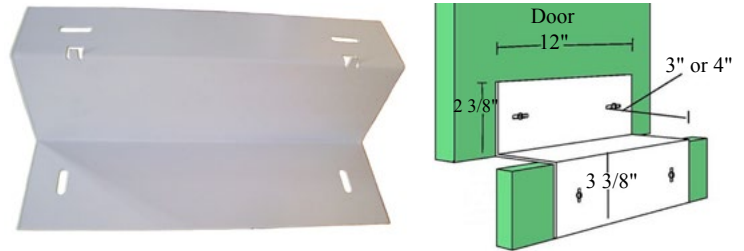

18 gauge steel powder coated bracket allows the toe kick to swing out with the cabinet door allowing unimpeded access for wheel chairs to sink, counter, desk, or other work areas.  
Stocked in white, available in black by special order.

Part Number	Size	Color	Box Quantity
JGEZ20003	3"	White	10 pair
JGEZ20003BK	3"	Black	10 pair
JGEZ20004	4"	White	10 pair

## Modesty Panel Clip Bracket

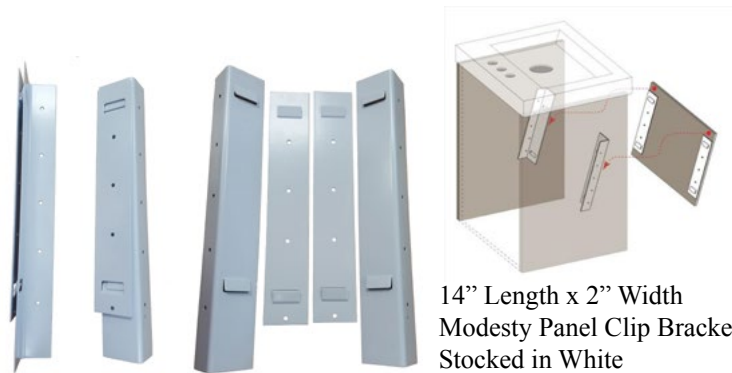

14" Length x 2" Width  
Modesty Panel Clip Bracket  
Stocked in White  
Packed 12 pairs per Box

Part Number: JGMPC

## Table Top Evener



3/4" x 2"  
Plain  
Packed 1,000 per Box

Part Number: 7104TE752



KV Figure 8 Desk Top Fastener  
12 Gauge  
Packed 100 per Box  
Part Number: KV1547STL - Steel  
\*Recommended Screws: #6 Flat Head

## Panel Fasteners



6' Panel Fastener has holes every 8".

\*Recommended Screws:  
#8 or #10 x 5/8" Pan Head

Part Number	Length	Gap Size	Finish	Box Quantity
7106P533720	1 1/2"	3/16"	Aluminum	1,000
7106P53383	3" No Holes	3/16" Heavy Duty	Aluminum	200
7106P533872	6" No Holes	3/16" Heavy Duty	Aluminum	100
7106P54032	2"	1/4"	Aluminum	500
7106P540372	6'	1/4"	Aluminum	20

## Shelf Stiffener



8' Shelf Stiffener  
Zinc  
Packed 25 per Box

Part Number: 7106P54798CL

## J Door Pull

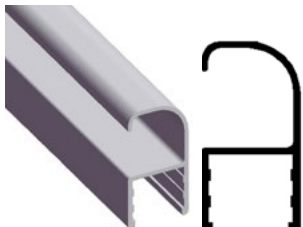

3/4" x 8' J Door Pull  
Aluminum  
Packed 12 per Box

Part Number: 7106P6920

## Interlocking Panel Fasteners



1 1/2" x 1 3/4" Interlocking Panel Fasteners  
Zinc  
Packed 200 Pairs per Box  
Part Number: 7104K418Z

\*Recommended Screws: #6 Flat Head

## Bed Fittings - End Rail Mount



Selby  
Heavy Duty - .125 Gauge Steel  
Packed 6 Sets per Box  
8 Pieces per Set

\*Recommended Screws: #8 Flat Head

Part Number	Width	Length	Finish
7327133008	11/16"	4"	Plain
7327133090	11/16"	5"	Plain
7327133008B	11/16"	6"	Plain

## Bed Lock Headboard Bracket



3 3/4" Single 1 1/2" Return  
Packed 48 per Box  
Part Number: 71045314403405 - Brown

\*Recommended Screws: #8 Pan Head

## Bed Fittings - Keyhole Bracket



\*Recommended Screws:  
#8 Pan Head

Part Number	Leg Diameter	Length	Description	Finish
710101C	1 1/4" x 1 1/4"	6"	Corner Bracket	Plain

## Bed Fittings - Four Poster Bracket



6" x 1 1/4" x 7/8"  
Plain  
Packed 50 per Box

Part Number: 710104C

\*Recommended Screws: #8 Pan Head

Brackets &  
Extrusions



## Offset Brackets



8" Z Bracket 1" Offset  
Packed 500 per Box  
Part Number: 710118Z - Plain  
\*Recommended Screws: #6 Pan Head

## Corner Brackets



1" x 1" x 2" Corner Bracket  
3/16" Holes 16 Gauge  
Reinforced Corner Bracket 16 Gauge  
Packed 800 per Box  
Part Number: 710105CRB - Black  
\* Recommended Screws: #8 Pan Head

1 1/4" x 1 1/4" x 2 1/4" Corner Bracket  
3/16" Holes 16 Gauge  
Reinforced Corner Bracket 16 Gauge  
Packed 500 per Box  
Part Number 7101CB90 - Black  
\* Recommended Screws: #8 Pan Head



1" x 1" Corner Brace  
Plain  
Packed 1,000 per Box  
Part Number: 710111CB  
\*Recommended Screws: #8 Pan Head

Brackets &  
Extrusions



1" x 1" x 1/2" Countersunk L Bracket  
Packed 1,000 per box

Zinc Part Number: 710111LC  
Black Part Number: 71011108LR  
\*Recommended Screws: #6 Flat Head



1 1/2" x 1 1/2" x 1/2" L Bracket  
Packed 1,000 per Box  
Part Number: 71011202LC - Zinc  
\*Recommended Screws: #6 Flat Head

2" x 2" x 5/8" Countersunk L Bracket  
Packed 1,000 per Box  
Part Number: 71011302LC - Zinc  
\*Recommended Screws: #6 Flat Head

## Flat Brackets

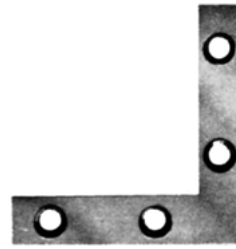

3/8" x 2" x 2" Flat Bracket  
Plain  
Packed 1,000 per Box

Part Number: 710130  
\*Recommended Screws: #5 Flat Head



1/2" x 2" Mending Plate  
3/16" Holes 16 Gauge Countersunk  
Packed 2,000 per Box

Part Number: 710124F - Zinc  
\*Recommended Screws: #6 Flat Head



1/2" x 3" Mending Plate  
3/16" Holes 16 Gauge Countersunk  
Packed 2,000 per Box

Part Number: 710121F - Zinc  
\*Recommended Screws: #6 Flat Head



5/8" x 4" Mending Plate  
3/16" Holes 16 Gauge Countersunk  
Packed 1,000 per Box

Part Number: 71012202F - Zinc  
\*Recommended Screws: #6 Flat Head



2" x 6" Flat Bracket  
3/16" Holes 16 Gauge  
Packed 100 per Box

Part Number: 710106F - Black  
\*Recommended Screws: #6 Pan Head



2" x 4" Flat Bracket  
12 Gauge  
Packed 300 per Box

Part Number: 710109FB - Black  
\*Recommended Screws: #8 Pan Head



## Pull Out Mounting Bracket



2 1/2" Slide Mounting Bracket  
Uses 4mm Machine Screws to mount slide.  
Packed 200 per Box.

Part Number: 7101BMB

## Cover Caps

### Cover Caps For Cam 15 Fittings

**Titus**  
Fittings for purpose



Part Number	Color	Box Quantity
6701026	Black	5,000
6701026GA	Magnolia	5,000
6701026KA	Koko Brown	5,000
6701026WA	White	5,000

### Cover Caps For Drywall or System Screws

**Titus**  
Fittings for purpose



Part Number	Color	Box Quantity
6701020AA	Almond	10,000
6701020KA	Dark Brown	10,000
6701020LA	Black	10,000
6701020TA	Light Brown	10,000
6701020WA	White	10,000
6701020ZA	Gray	10,000

## Fastcaps

See Fastcap page 151.



## Edgebanding

### Melaband - Duraedge

Polybond is a Heavy-Weight (two ply) Polyester Edgeband. Widths that are available by special orders are 1/2", 5/8", 11/16", 3/4", 7/8", 1", 1 1/8", 1 1/4", 1 1/2", and 2". Other colors available upon special order.

**DURA EDGE**  
incorporated

Color	Width	Glue	Part Number	Feet Per Roll
Almond Textured	13/16"	Yes	7202M2L4002XR	250
White Textured	13/16"	Yes	7202M2L4001XR	250

## Edgebanding

### Polywood Veneers - Adwood

Polywood is Expertly Matched, Finger Jointed and Laminated to a Crepe Membrane. Widths Available by Special Order are 1/2", 9/16", 5/8", 11/16", 3/4", 13/16", 7/8", 15/16", 1", 1 1/8", 1 1/4", 1 3/8", 1 1/2", 1 3/4", and 1 7/8".

Colors Available by Special Order are Red Oak, White Birch, Maple, White Ramin, Red Birch, Sapele Ribbon, American Cherry, Radianta Pine, Rift White Oak, White Ash, Honduras Mahogany, Clear Pine, Walnut, and Teak.



Cover Caps/  
Edgebanding

Color	Width	Glue	Part Number	Feet Per Roll
Maple	7/8"	No	7203509578	500
Maple	13/16"	Yes	720350971316G	250
Red Oak	7/8"	No	7203511578	500
Red Oak	13/16"	Yes	720351171316G	250
White Birch	7/8"	No	7203522778	500
White Birch	7/8"	Yes	7203522778G	250
Alder	7/8"	No	72036001478	500
Alder	7/8"	Yes	72036001478G	250
Cherry	7/8"	No	7203508578	500
Cherry	13/16"	Yes	720350851316G	250
Rift White Oak	7/8"	No	7203521878	500
Rift White Oak	1 1/8"	No	72035218118	500
Walnut	7/8"	No	7203505578	500
Walnut	7/8"	Yes	7203505578G	250

## Edgebanding

### PVC "Dura Edge" - Duraedge

PVC Edgebanding for Melamine and High or Low Pressure Laminates  
No Glue

**DURA EDGE**  
incorporated



Color	Width	Part Number	Feet Per Roll	Rolls Per Box
White	3/4"	72016059TX34	1,200	6
White	7/8"	72017001TX	1,200	5
White	15/16"	72017001TX1516	600	5
Black	5/8"	72017003TX58	1,200	7
Black	3/4"	72017003TX34	1,200	6
Black	7/8"	72017003TX	1,200	5
Almond	7/8"	72017002TX	1,200	5
Almond	15/16"	72017002TX1516	600	5
Almond Contempo	15/16"	720190051516	600	5
Almond Cherry	15/16"	72011243	600	5
Arch Maple	15/16"	72011061	600	5
Audacity	15/16"	72014250	600	5
Brick Birch	15/16"	72011050	600	5
Buttermilk Cherry	15/16"	72011116	600	5
Captiva Maple	15/16"	72018442	600	5
Cashmere Grey	15/16"	72011048CG1516	600	5
Castle Oak	15/16"	720183381516	600	5
Chocolate Peartree	15/16"	72014172	600	5
Country Maple	15/16"	72011008	600	5
Gray Contempo	3/4"	7201828434	1,200	6
Hardrock Maple	15/16"	72014254	600	5
Liberty Red	15/16"	72017047T1516	600	5
Maple	15/16"	72018567	600	5
Medium Cherry	15/16"	72012620	600	5
Paprika Maple	15/16"	7201104871516	600	5
Regal Cherry	15/16"	72018725	600	5
Riviera Maple	15/16"	72018665	600	5
Roadhouse Maple	15/16"	7201104851516	600	5
Sugar Cane Maple	15/16"	7201104861516	600	5
Summer Flame	15/16"	72011196	600	5
Vessel Oak	15/16"	72018067	600	5

Edgebanding

## Edgebanding

### Patwin T-Molding



Face Width	Barb Thickness	Overall Height	Color	Part Number	Feet Per Roll
5/8"	0.09	11/32"	White	72P50058601	1,000
5/8"	0.09	11/32"	Black	72P50058260	1,000
5/8"	0.09	11/32"	Tan	72P50058039	1,000
5/8"	0.09	11/32"	Almond	72P50058770	1,000
3/4"	0.105	11/32"	Tan	72P50034039	1,000
3/4"	0.105	11/32"	Black	72P50034260	1,000
3/4"	0.105	11/32"	White	72P50034601	1,000
1 1/4"	0.125	5/8"	Black	72P575114260	1,000

## The Smart Clip

For Applying Backsplashes to Nearly Any Wall Surface.

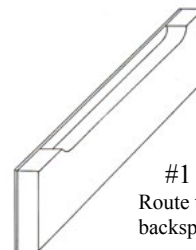

#1  
Route the laminated backsplash.

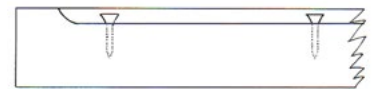

#2  
After measuring and drilling 12 inch intervals on the backsplash, install screws into the bottom of the backsplash.

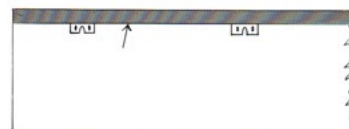

#3  
Install the Smart Clips on the countertop, butting the wall, using the screws provided.

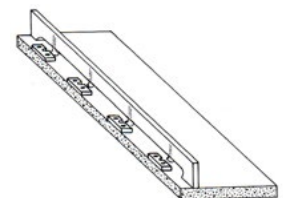

#4  
Run a bead of caulk along the line of Smart Clips, and drive the backsplash into position.

Part Number	Description	Box Quantity
7104SC	Smart Clip with Screw	250
7104SC1	SC-1 Router Bit	1
7104SC5B	#5-B Spacing Bar	1
7104SC8G	#8 Screw Depth Gauge	1





## Fast Edge

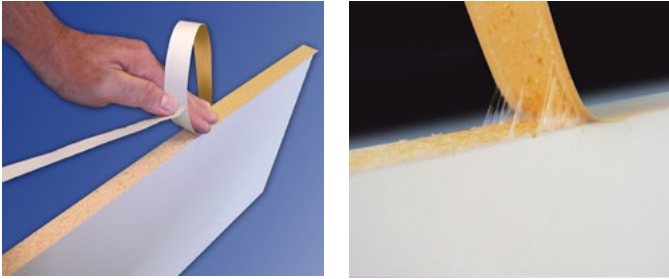

Fastedge is self adhesive edging.  
 Fastedge is available in any FastCap PVC Color, PVC Woodgrain, Solid Real Wood, Prefinished Wood, or Metallic.  
 Custom colors are available for special order.  
 Fastedge is available in the following widths - 1/2", 3/4", 7/8" and 15/16"  
 Fastedge is available in the following feet per roll - 50 ft and 250 ft.

Color	Width	Part Number	Feet Per Roll
Almond	1/2"	7212FE12250ALM	250
Almond	15/16"	7212FE1516250ALM	250
Black	15/16"	7212FE1516250BLK	250
White	15/16"	7212FE1516250WH	250
Hardrock Maple	15/16"	7212FE1516250HM	250
Light Maple	15/16"	7212FE1516250LMPL	250

\*Edge Trimmer is available, see page 152.

## Plastic Finishing Plugs



Hole Diameter	Part Number	Color	Box Quantity
5mm/ 3/16"	71460205OA	Oak	2,500
5mm/ 3/16"	71460205W	White	2,500
10mm/ 25/64"	71460207AL	Almond	1,000
10mm/25/64"	71460207BK	Black	1,000
10mm/ 25/64"	71460207WH	White	1,000
6mm/ 1/4"	71460214BK	Black	1,000
12mm/ 1/2"	71460228WH	White	5,000

## Nylon Locking Hole Plug



Hole Diameter	Part Number	Color	Box Quantity
7/8"	714662MP0875W	White	1,000

## Castle Cap



1924 Castle Cap  
 Black Plastic

Part Number: 71461924BK

## Plastic Corner Braces



13/16" x 13/16" x 2"  
 Glue, Staple or Screw On Brace  
 Packed 3,000 per Box  
 Part Number: 71191698BK - Black  
 Part Number: 71191698 - Natural  
 \*Recommended Screws: #6 Pan Head

## Plastic Concealed Braces



Packed 1,000 per Box  
 Part Number: 71191655BK - Black  
 Part Number: 71191655WH - White  
 \*Recommended Screws: #6 Pan Head

Edgebanding  
 /Plugs/Braces

## Plastic Corner Braces

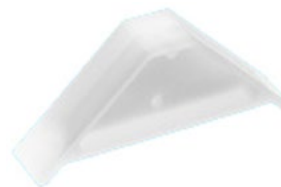

2 1/2" x 2 1/2"  
 Staple or Screw On Brace  
 Packed 1,500 per Box

Part Number: 71191693 - White



2 1/2" x 2 1/2"  
 With reference tabs.  
 Staple or Screw On Brace  
 Packed 1,500 per Box

Part Number: 71441695 - White

## Plastic Corner Braces



Staple On Brace  
Stocked in White  
Available in other colors  
Packed 1,200 per Case

Part Number: 714604447

## False Front Clips



Face Frame Clip  
Packed 500 per Case  
Part Number: 7146FFC11

Face Frame Clip Roller  
Packed 500 per Case  
Part Number: 7146FFS11

## Door Spacers



Tube-Its Spacer



Synergy Spacer

Braces,  
Bumpers

Part Number	Description	Color	Box Quantity
JBL519G	#519-G Tube-Its Spacer	Tan	40,000
JBL529G	#529-G Tube-Its Spacer	Tan	40,000
JBLHS265	#265 Synergy Spacer	Tan	40,000

## Hex Bumpers

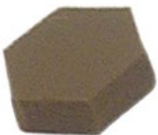

Part Number	Size	Color	Box Quantity
7129AG38W5	3/8" W x 1/8" T	Off White	5,000
7129AG38B5	3/8" W x 1/8" T	Brown	5,000

## Poly Self Adhesive Bumpers



5/16" Hemispherical  
.335" Wide x .085" Thick  
Stocked in Clear  
450/Sheet 11,250/Box  
Part Number: 7129BS7SD



3/8" Hemispherical  
.375" Wide x .15" Thick  
Stocked in Clear  
288/Sheet 7,200 per Box  
Part Number: 7129BS12



3/8" Hemispherical  
.375" Wide x .211" Thick  
Stocked in Clear  
300/Sheet 6,000 per Box  
Part Number: 7129BS22



1/2" Cylindrical  
.50" Wide x .14" Thick  
Stocked in Clear  
200/Sheet 5,000/Box  
Part Number: 7129BS1SD



1/2" Specialty Quiet Bumper  
.50" Wide x .14" Thick  
Stocked in Clear  
200/Sheet 5,000 per Box  
Part Number: 7129BS58SD



1/2" Pyramidal  
.500" Wide x .150" Thick  
Stocked in Clear  
200/Sheet 5,000 per Box  
Part Number: 7129BS33SD

## 3M™ Bumpon™ Protective Products

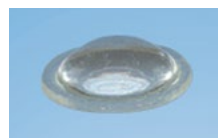

SJ-5302 Bumpon™  
.312" Wide x .085" Thick  
Stocked in Clear.  
Packed 3,000 per Box  
Part Number: 3M02120040230



SJ-6553 Bumpon™ Quiet  
.375" Wide x .12" Thick  
Stocked in Clear.  
Packed 5,000 per Box  
Part Number: 3M02120045043



## Joiner Biscuits



Description	Part Number	Packed Per Bag
#0 Biscuit	7152400	1,000
#10 Biscuit	71524010	1,000
#20 Biscuit	71524020	1,000

## Wood Dowels



### Fluted Wood Dowels

Diameter	Length	Part Number	Box Quantity
1/4"	1"	71511416F	40,000
1/4"	1 1/4"	71511418F	34,000
5/16"	1 1/2"	71512520F	20,000
3/8"	1 1/2"	71512620F	14,000
3/8"	2"	71512624F	10,000
3/8"	2 1/2"	71512626F	8,000
3/8"	3"	71512628F	5,500
1/2"	3"	71512828F	3,500
1/2"	3 1/2"	71512830F	2,750
1/2"	4"	71512832F	2,500
5/8"	3"	71513028F	2,300
5mm	25mm	71510525	32,000
8mm*	25mm	71510825	23,000
8mm*	30mm	71510830	19,200
8mm	30mm	71510830FPG**	20,000
8mm*	35mm	71510835	16,400
8mm	38mm	71510838FPG**	15,000

\*8mm Glue Capsules available for 8mm dowels. See page 168.

\*\*Indicates Pre-Glued.

### Spiral Groove Wood Dowels

Diameter	Length	Part Number	Box Quantity
7/16"	2"	71512724	7,500
1/2"	5"	71512836	1,900
5/8"	4"	71513032	1,650

## Wood Plugs

Minimum Quantity 1,000 pieces



Button



Round



Flat

Diameter	Type	Wood	Part Number	Box Quantity
3/8"	Button	Oak	71520326O	5,000
3/8"	Button	Birch	71520326	5,000
3/8"	Button	Maple	71520326M	5,000
1/2"	Button	Oak	71520328O	10,000
1/2"	Button	Birch	71520328	10,000
3/8"	Round	Birch	71520126	3,000
3/8"	Flat	Oak	71520226O	1,000
3/8"	Flat	Birch	71520226	4,000
1/2"	Flat	Birch	71520228	5,000
1/2"	Flat	Face Grain Oak	71520228OF	5,000
1/2"	Flat	Face Grain Maple	71520228MF	5,000
1/2"	Flat	Face Grain Poplar	71520228PF	5,000
1 1/4"	Flat	Maple	71520238M	2,000
1 1/4"	Flat	Face Grain Oak	71520238OFG	1,000

## Nylon Twin Wheel Casters

### 3/4 U-Channel



Part Number	Size	Load Capacity	Color	Case Quantity
71482408U	50mm	75 lbs	Black Hood	140

### Plate



Part Number	Size	Load Capacity	Color	Case Quantity
71484108	40mm	75 lbs	Black Hood	200
71482408H	50mm	75 lbs	Black Hood	200
71482408B	50mm	75 lbs	Black Hood and Brake	200
71486008	60mm	75 lbs	Black Hood	200

Wood Dowels /Plugs/Casters

## Nylon Twin Wheel Casters

### Friction



Part Number	Size	Load Capacity	Color	Case Quantity
71482408FAB	50mm	75 lbs	Antique Brass Hood	140

### Stem and Plastic Stem Insert

Kit contains 4 Casters and 4 Plastic Stem Inserts



Part Number	Size	Load Capacity	Color	Case Quantity
71482408SK	50mm	75 lbs	Black Hood	50 Kits



Metal Stem Insert  
Part Number:  
71482408SIM



Plastic Stem Insert  
Part Number:  
71482408SI

## General Duty Casters C-GD Series



Stocked in Hard Rubber.  
Available with Soft Rubber, Plastic,  
Non-Marking, and Steel Wheels.  
Stocked in Rigid, Swivel, and Swivel with Brake.  
Zinc plated with metal ball bearing.

Part Number	Wheel Size	Type	Load Capacity	Plate Size	Hole Spacing	Bolt Size	Swivel Radius	Overall Height
7148CGD20HRS	2"	Swivel	125 lbs	1 7/8" x 2 9/16"	1 5/16" x 2 1/8"	1/4"	2 5/8"	2 7/16"
7148CGD20HR SB	2"	Swivel with Brake	125 lbs	1 7/8" x 2 9/16"	1 5/16" x 2 1/8"	1/4"	2 5/8"	2 7/16"
7148CGD20HRR	2"	Rigid	125 lbs	1 1/2" x 2 1/32"	1 5/16" x 2 1/8"	1/4"	Rigid	2 7/16"
7148CGD25HRS	2 1/2"	Swivel	175 lbs	2 3/4" x 3 7/8"	1 3/4" x 3"	5/16"	2 3/8"	3 1/4"
7148CGD25HR SB	2 1/2"	Swivel with Brake	175 lbs	2 3/4" x 3 7/8"	1 3/4" x 3"	5/16"	2 3/8"	3 1/4"
7148CGD25HRR	2 1/2"	Rigid	175 lbs	2 1/4" x 4 7/16"	1 1/16" x 3 1/2"	5/16"	Rigid	3 1/4"
7148CGD30HRS	3"	Swivel	250 lbs	3 1/8" x 4 1/8"	2 3/8" x 3 3/8"	5/16"	2 7/16"	3 3/4"
7148CGD30HR SB	3"	Swivel with Brake	250 lbs	3 1/8" x 4 1/8"	2 3/8" x 3 3/8"	5/16"	2 7/16"	3 3/4"
7148CGD30HRR	3"	Rigid	250 lbs	2 1/2" x 4 15/16"	1 3/16" x 4"	5/16"	Rigid	3 3/4"
7148CGD40HRS	4"	Swivel	300 lbs	4" x 5 1/8"	3" x 4"	3/8"	3"	5"
7148CGD40HR SB	4"	Swivel with Brake	300 lbs	4" x 5 1/8"	3" x 4"	3/8"	3"	5"
7148CGD40HRR	4"	Rigid	300 lbs	3 1/8" x 6 1/4"	1 3/4" x 5"	3/8"	Rigid	5"

Casters

## Carpet Covered Dollies

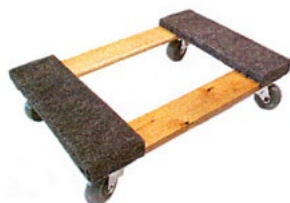

DL31624



DL41931 - Heavy Duty

Size	Part Number	Load Capacity	Wheel Size	Wheel Type
16" x 24"	7148DL31624MS	600 lbs	3"	Non-Marking
19" x 31"	7148DL41931MS	1,000 lbs	4"	Non-Marking



## Furniture Fittings

### Support Bracket Zinc



3/8-16 Thread  
1 5/8" Width  
1 1/2" Depth

Part Number: 715026UB

### Corner Bracket - Zinc



3/8-16 Thread  
Width 2 53/64" x 2 53/64"  
Depth 13/16"

Part Number: 715026CB

### U-Bracket - Black



Part Number	Thread Size	For Material Thickness	Color	Box Quantity
7363795311	1/4-20	3/4"	Black	100

### Floor Glides - Type A



Part Number	Stem Thread	Stem Length	Base Width	Case Quantity
71502620	3/8-16	1 1/2"	1 1/2"	500

## Furniture Fittings

### Floor Glide - Hex, Zinc



Part Number	Stem Thread	Stem Length	Base Width	Case Quantity
71501416ZH	1/4-20	1"	1"	100
71502628ZH	3/8-16	3"	1 3/8"	100

### Floor Glides - Silencer



Part Number	Stem Thread	Stem Length	Base Width	Case Quantity
71501416	1/4-20	1"	1"	1,000

### Floor Glides - Cushioned, Plated



Part Number	Stem Thread	Stem Length	Base Width	Case Quantity
71501412C	1/4-20	3/4"	7/8"	1,000
71501416C	1/4-20	1"	7/8"	1,000

### Floor Glide - Type B

Comes with T-Nut



Part Number	Stem Thread	Stem Length	Base Width	Color	Case Quantity
71502521P	5/16-18	1 5/8"	1"	Natural	500

Levelers  
/Glides



## Furniture Fittings

### Tack Glide - Flat



Part Number	Base Width	Case Quantity
714710F	5/8"	5,000
714712F	3/4"	5,000
714714F	7/8"	4,000

### Tack Glide - Round



Part Number	Base Width	Case Quantity
714708R	1/2"	5,000
714712R	3/4"	5,000

### Tack Glide



Part Number	Base Width	Length	Color	Case Quantity
714734105	5/8"	1 1/4"	White	5,000

### Tack Glide - Silencer



Part Number	Base Width	Color	Case Quantity
714714SB	7/8"	Black	2,000

### Tack Glide - Cushioned, Plated



Part Number	Base Width	Color	Case Quantity
714714C	7/8"	Nickel	1,000
714720C	1 1/2"	Nickel	1,000

### Tack Glides - 3 Prong Plain



Part Number	Base Width	Case Quantity
7147323P	3/4"	2,500

**Titus**  
Fittings for purpose

## Cabinet Levelers - Titus

### Plastic Leveler - Black



92mm-150mm  
Packed 200 per Case

Part Number: 6702666LA

### Leg Extender - Black

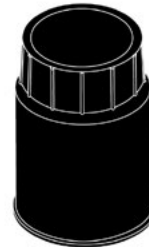

50mm  
Packed 200 per Case

Part Number: 6702571LA

### Toe Kick Clip - Black



Comes with Screw On and  
Knock In Plate  
Packed 200 per Case

Part Number: 6702523L

### Knock In Fixing Block - Black

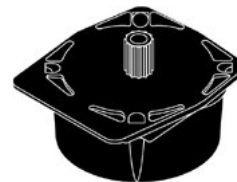

Packed 200 per Case

Part Number: 6702558LA

### Screw On Fixing Block - Black



Packed 200 Per Case

Part Number: 6702559LA

Levelers  
/Glides



## Connectors



#20 Griplox Biscuits  
Packed 200 per Box  
Part Number: SLBISCUIT20



Striplox Pro 23  
3 1/2" Length  
200-350 lb load capacity  
Packed 100 per Box  
Part Number: SL101023103



Striplox Pro 55  
4 31/32" Length  
230-440 lb load capacity  
Packed 50 per Box  
Part Number: SL101055103



Striplox Megalox  
10" Length  
330-650 lb load capacity  
Packed 50 per Box  
Part Number: SL106241103



Striplox Clip 50  
200-275 lb load capacity  
Packed 100 per Box  
Part Number: SL104050103



Striplox Mini 60 Joiner  
Packed 200 per Box  
Part Number: SL102060103



Striplox Mini 120 Joiner  
Packed 100 per Box  
Part Number: SL102120103



## Connectors



Striplox 180D  
440-500 lb load capacity  
Packed 20 per Box  
Part Number: SL105114103



Striplox 90D 98mm  
Right Angle Joiner  
Packed 50 per Box  
Black Part Number: SL103098103  
White Part Number: SL103098203

## Accessories



7mm Router Bit  
Packed 10 per Box  
Part Number: SL160007107

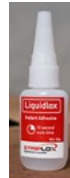

Liquidlox 20 grams  
Adhesive compatible with all Striplox  
assembly products.  
Packed 10 per Box  
Part Number: SL170020012

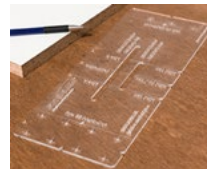

Mark-Out Template  
Packed 10 per Box  
Part Number: SL150000004

Connecting  
Fittings



Pro Jig Sets  
Packed 12 per Box  
Pro 23 Part Number: SL180023303  
Pro 55 Part Number: SL180055303  
Clip 50 Part Number: SL180050303

Connecting Fittings - Titus

Drawer Front Adjuster



Eliminates uneven drawer banks.  
Multi-direction adjustment.  
Locking screw to fasten.  
Independent of drawer system.  
One piece housing.  
Fits in 25mm hole

Brown Part Number: 6706309KA

System 5

Klix Cam



Part Number	Hole Size	Depth	Color	Case Quantity
6705654ZN*	15mm	12mm	Zinc	2,000

\*Indicates hex drive.

Quickfit Push-in Dowels



Part Number	Length	Hole Size	Color	Case Quantity
6705810YA	24mm	10mm	Gray	2,000

Quickfit Dowels



Part Number	Length	Thread Size	Color	Case Quantity
6705563	24mm	8mm	Dark Gray	2,000
6705554YA	34mm	8mm	Dark Gray	2,000

Connecting Fittings

System 6

Camfix



Size	Type	Part Number	Color	Case Quantity
19mm	Drop-On	6706397CA	Candlelight	1,250
19mm	Drop-On	6706397LA	Black	1,250
19mm	Drop-On	6706397MB	Almond	1,250
19mm	Drop-On	6706397WA	White	1,250

Connecting Fittings - Titus

System 6

Camfix



Size	Type	Part Number	Color	Case Quantity
16mm	Drop-On	6706383CL	Brown	2,500
16mm	Drop-On	6706383LA	Black	2,500
16mm	Drop-On	6706383WA	White	2,500
19mm	Drop-On	6706387CL	Brown	2,500
19mm	Drop-On	6706387LA	Black	2,500
19mm	Drop-On	6706387MB	Almond	2,500
19mm	Drop-On	6706387WA	White	2,500

Quickfit Dowel



Part Number	Length	Thread Size	Color	Case Quantity
6706408YA	12mm	5mm	Gray	5,000

Klix Euro Dowel



Part Number	Length	Hole Size	Color	Case Quantity
6706406ZN	11mm	5mm	Zinc	5,000

Double Dowel



Part Number	Length	Hole Size	Color	Case Quantity
6706416ZN	19mm	3mm or 5mm	Zinc	2,500

## Connecting Fittings Connector Screw

Confirmat Screw in Zinc.



Size	Part Number
5mm x 40mm	7326437098
7mm x 50mm	7326442197
7mm x 50mm with Nibs and Sharp Point	7326444190
7mm x 70mm	7326442295

Step Drill for confirmat screws see page 180.

## Thread Connectors

Sleeve with Screw End



Size	Part Number	For Wood Thickness
4mm x 31.5mm	631072393	35mm - 38mm

## Screws



Size	Part Number
4mm x 11.5mm	631058986

## Additional Sleeves



Size	Part Number
4mm x 15mm	631004938
4mm x 40mm	631004942

## Cross Dowel Nuts



Connecting Fitting Type JCD. For use with Type BA, BB, and BC.

Size	Part Number
1/4-20 x 16mm	3602141601

## Insert Nuts - Hex Drive



Stocked in Zinc plating

Size	Type	Drive	Part Number
8-32 x 10mm	D	4mm Hex	3601081002
10-24 x 13mm	D	5mm Hex	3601101302
10-24 x 13mm	E	5mm Hex	3601101302E
1/4-20 x 13mm	D	6mm Hex	3601141302
1/4-20 x 20mm	D	6mm Hex	3601142002
1/4-20 x 25mm	D	6mm Hex	3601142502
5/16-18 x 13mm	D	8mm Hex	3601251302
5/16-18 x 13mm	B	Knock-In	3601251302B
5/16-18 x 15mm	SK	8mm Hex	3601251502SK
5/16-18 x 25mm	D	8mm Hex	3601252502

## Joint Connector Nuts



Connecting Fittings for use with Type BA, BB, and BC Connector Bolts. 5mm Hex Drive

Size	Part Number	Finish
10-24 x 16mm	3603101608	Black
1/4-20 x 17mm	3603141707	Bronze
1/4-20 x 17mm	3603141708	Black

Connecting Fittings

## Joint Connector Lags



Hex Drive Decorator Head,  
Stocked in Bronze. 4mm Hex  
Drive

Size	Head Diameter	Part Number	Finish
7mm x 50mm	17mm	3613075007	Bronze
7mm x 100mm	17mm	36130710007	Bronze

## Joint Connector Bolts

Type BA 17mm Head Shoulder, 5mm Hex Drive



Size	Part Number	Finish
1/4-20 x 35mm	3611143508S	Black
1/4-20 x 35mm	3611143507S	Bronze
1/4-20 x 50mm	3611145007S	Bronze
1/4-20 x 60mm	3611146007S	Bronze

Type BB No Shoulder 17mm Head  
4mm Hex Drive



Size	Part Number	Finish
1/4-20 x 30mm	3611143008	Black
1/4-20 x 35mm	3611143507	Bronze
1/4-20 x 50mm	3611145007	Bronze
1/4-20 x 60mm	3611146007	Bronze
1/4-20 x 70mm	3611147008	Black
1/4-20 x 80mm	3611148006	Brass
1/4-20 x 80mm	3611148007	Bronze

Connecting Fittings  
/Catches

Type BC No Shoulder 13mm Head  
4mm Hex Drive



Size	Part Number	Finish
1/4-20 x 50mm	361114500713	Bronze
1/4-20 x 60mm	361114600813	Black

## Magnetic Catches

Hi Rise Single Magnetic Catch 8#



Part Number	Color	Box Quantity
7125M0303932	Brown	250

Double Magnetic Catch 8#



Part Number	Color	Box Quantity
7125M0303941W with Strike & Screws	White	100

Single Magnetic Catch 13#



Part Number	Color	Box Quantity
732462610443	Brown	100
7324626300	Black	100

Single Magnetic Catch 13#



Part Number	Color	Box Quantity
7125M02X3921 with Strike & Screws	White	500
7125M02X3921BR with Strike & Screws	Brown	500

Aluminum Single Magnetic Catch 15#



Part Number	Color	Box Quantity
7125M0303949 with Strike	Aluminum	100

High Profile Single Magnetic Catch 25#



Part Number	Color	Box Quantity
7125M0303950	Brown	100
7125M0203950W with Strike & Screws	White	100



## Magnetic Catches

### Single Magnetic Catch



Part Number	Color	Box Quantity
EP591 with Strike & Screws	Aluminum	100

### Round Mortise 9 lb

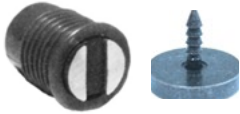

9/16" Diameter, Brown  
Part Number: 7125M0303917  
14mm Diameter, Brown  
Part Number: 6357273901  
Strike Part Number: 7125M0302908  
Packed 1,000 per Case

### Recommended Screws



4x5/8 Phil Pan TSA for items shown  
above and to the left.

## Magnetic Touch Catches

### Single Round



Part Number	Color	Case Quantity
7324560709	White	1,000
7324560307	Black	1,000

### Double Round



Part Number	Color	Case Quantity
7324560736	White	500
7324560334	Black	500

### Single Square



Part Number	Color	Case Quantity
732457030743	Black	1,000

## Magnetic Touch Catches

### Double Square

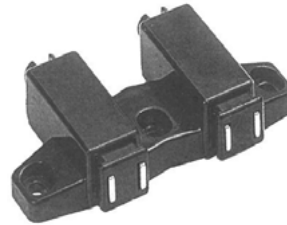

Part Number	Color	Case Quantity
7324569328	Black	500

### Recommended Screws



#6 Pan Head TSA for touch catches

## Receiver Catches

### Receiver Catch and Button Set



Catch



Button

Part Number	Color	Box Quantity
7125BSHC2BP	Brass	100
7125BSHC2WH	White	100
7125BSHC2ZP	Zinc	100

### Roller Catch



Strike and Screws Included  
Zinc Part Number: 6698232G  
Jumbo Stat Bronze  
Part Number: 7125M5CBZ  
Packed 25 Sets per Box

### Internal Spring Roller Catch



Stat Bronze  
Packed 100 Sets per Box

Part Number: 7125M0399388SB  
\*Recommended Screws: 6x5/8  
Pan Head

Catches

## Catches

### Non-Magnetic Touch Latch - Sugatsune



Strike Included  
Packed 30 Sets per Box

Black Part Number: SGM37BK  
White Part Number: SGM37WH

### Keku Fasteners - Hafele



Keku AS Push Panel Clip Black  
Part Number: 7326250368

Keku AS Push Frame Clip Black  
Part Number: 7326250359

Packed 100 per Box



Keku Hook On Fastener  
Frame Component Black  
Part Number: 7326249365

Keku Hook On Fastener  
Panel Component Black  
Part Number: 7326249356

Packed 100 per Box

### Solid Brass Ball Catches

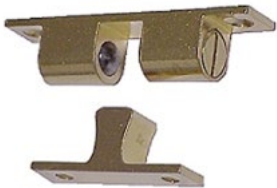

Strike Included  
1 3/4" Brass  
Part Number: 7125M034400B  
2" Brass  
Part Number: 7125M034900B  
58mm Dull Chrome  
Part Number: EP1013DC  
Packed 100 Sets per Box

\*Recommended Screws: 4x5/8 Flat Head

## Catches

### Spring Loaded Sash Lock

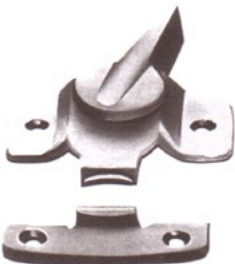

Zinc  
Packed 250 per Box

Part Number: 7125B01S3855  
\*Recommended Screws: #6x3/4 Flat Head

## Elbow Catches



Aluminum  
Part Number: 7125M0399389

Zinc  
Part Number: 7125M0399389ZN  
Packed 50 Sets per Bag

\*Recommended Screws:  
6x5/8 Pan Head

## Chain Bolt



3/8" Chain Bolt Zinc  
Packed 20 per Box

Part Number: EPCB3ZP

## Striker Plates



21mm H x 26mm L  
Stocked in Stat Bronze Only  
Packed 5,000 per Box

Part Number: 6357280001



Part Number	Size	Color	Box Quantity
7125M040290102	22mm x 30mm	Zinc	4,000
7125M0402901	22mm x 30mm	Stat Bronze	4,000



### Recommended Screws

5x1/2 Phil Flat TSA for striker plates.

### Striker Plate Fits 3-5mm Glass



Part Number	Size	Color
7324563826	22mm x 40mm	Brass
7324563326	22mm x 40mm	Black

### Pull Lip Striker Plate Fits 3-5mm Glass



22mm H x 40mm L  
Felt Pad Included  
Stocked in Brass Only

Part Number: 7324563835

### Flexa-Touch Drawer Opener - Bainbridge Mfg.



Spring Loaded  
Mounts on or thru back of drawer  
7/8" adjustment  
Minimum 2 1/8"  
Maximum 3"  
Packed 50 per Box

Part Number: 71431021

### Shelf Clips



Diameter	Color	Part Number	Box Quantity
5mm	Bright Brass	7328204515	2,000
5mm	Nickel	7328204711	2,000
5mm	Black	7328204213	2,000
1/4"	Bright Brass	7328204533	2,000
1/4"	Nickel	7328204739	2,000
1/4"	Black	7328204337	2,000

### Straight Pins



Diameter	Color	Part Number	Box Quantity
5mm x 25mm	Nickel	7328240708	2,500

### Duplo Pin Center Collar



5mm Diameter  
Nickel  
Packed 2,500 per Box

Part Number: 7328243905

### Shelf Hold Down



5mm Shelf Hold Down  
Stocked in Natural.  
Packed 10,000 per Box

Part Number: 71441955

### Shelf Supports



Riveted Pin With Hole

Diameter	Color	Part Number	Box Quantity
5mm	Bright Brass	7328211565A	2,000
5mm	Nickel	7328211752A	2,000
5mm with Sleeve	Stat Bronze	7328211110B	2,000
5mm with Hole	Stat Bronze	7328211110H	2,000
5mm Long Pin	Bright Brass	7328211565L	4,000
1/4"	Bright Brass	7328211565	2,000
1/4"	Antique Brass	7328211113	2,000
1/4"	Nickel	7328211752	2,000
1/4"	Stat Bronze	7328211163	2,000
1/4" with Sleeve	Bright Brass	7328211565B	2,000

### Shelf Supports

Molded Plastic on Steel Pin



Pin Diameter	Color	Part Number	Box Quantity
5mm	Clear	7328227401	5,000
5mm	Almond	7328227509	5,000
5mm	White	7328227705	5,000

### Shelf Supports - Standard Plastic



Pin Diameter	Color	Part Number	Box Quantity
5mm	Champagne	7328222400	1,000

Shelf  
Supports



## Shelf Supports - Plastic



Pin Diameter	Part Number	Color	Box Quantity
5mm	71433221WH	White	1,500

## Locking Shelf Support - Titus



One 5mm Pin  
Locks Down 5/8" Shelf  
Stocked in Black  
Packed 4,000 per Box

Part Number: 6701828LA

## Locking Shelf Supports



71433253CL



32691 and 7736

Pin Diameter	Color	For Shelf Size	Part Number	Box Quantity
5mm	White	5/8"	714332691W	5,000
5mm	Clear	5/8"	71433223CL	5,000
5mm	Beige	3/4"	7328217736B	5,000
5mm	Clear	3/4"	71433253CL	5,000
1/4"	Clear	3/4"	71433245CL	10,000

## Locking Shelf Support - Standard



Shelf Supports

One 5mm Pin  
Locks Down 3/4" Shelf  
Stocked in Black  
Part Number: 71433226B  
Packed 2,500 per Bag  
Available in Brown, White, Tan, Oak, Charcoal, Birch, Putty, and Champagne.  
Also available for 1/2" and 5/8" Shelves.

## Locking Shelf Supports - Heavy Duty



3220

Two 5mm Pins  
Available in Tan, Oak, Charcoal, Putty, Birch, Black, and Champagne



3227

Pin Diameter	Shelf Size	Part Number	Color	Box Quantity
5mm	3/4" - 1"	71433220CL	Clear	1,000
5mm	3/4"	71433227	Almond	2,500
5mm	3/4"	7143H052003BK	Black	2,500
5mm	3/4"	71433227W	White	2,500
5mm	1"	71433228W	White	2,500

## Mirror Clips



Size	Part Number	Recommended Screws	Box Quantity
1/8"	714402	#6 Oval Head	1,000
3/16"	714403	#6 Oval Head	1,000
1/4"	714404	#6 Oval Head	1,000

## Mirror or Panel Clips



1803



1813



1823

Type	Color	Part Number	Recommended Screws	Box Quantity
Flush Mount	Clear	71441803PC	#6 Oval Head	10,000
Flush Mount	Tan	71441803T	#6 Oval Head	10,000
1/8" Offset	Clear	71441813PC	#6 Oval Head	10,000
3/16" Offset	Clear	71441823PC	#6 Oval Head	10,000

## Mirror or Panel Clips



1807

Size	Type	Part Number	Recommended Screws	Box Quantity
1/8"	Straight	71441806	#6 Pan Head	1,000
3/16"	Straight	71441807C	#6 Pan Head	1,000



## Glass and Panel Retaining Buttons



1/4" Offset Glass Retaining Button  
Clear  
Without Screw  
Packed 5,000 per Box  
Part Number: 7144H255CL

5/16" Offset Glass Retaining Button  
Clear  
Without Screw  
Packed 5,000 per Box  
Part Number: 7144H254CL

## Adjustable Glass Clip



Black  
Packed 1,000 per Box

Part Number: 7144ABK

## Mirror Hanger



Plain Steel  
Two hole  
Packed 1,000 per Box

Part Number: 71441003

\*Recommended Screws: #6 Pan Head

## Cable Clamp



3/8" Nylon PSA Clamp  
Black  
Packed 5,000 per Box

Part Number: 716122AWC00375B



3/8" Nylon PSA Cable Clamp  
Black  
Packed 5,000 per Box

Part Number: 716122SPC38562B



1/4" Nylon Cable Clamp  
White  
Packed 5,000 per Box

Part Number: 716122CC37D0250W

## Vent Grill



Part Number	Size	Color	Box Quantity
71441970BK	2 3/8" x 8 5/8"	Black	100
71441970TN	2 3/8" x 8 5/8"	Tan	100

## Wire J Channel



8' Wiremaster J Channel with PSA backing.  
Allows the user to easily hide wires out of view.

Part Number: 7161CPF31500T

## Import Trash Rings



Stainless steel trash rings.  
3/8" lip on all rings.

Part Number	Description	Finish	Box Quantity
PRTR6X1SS	6" x 1" Trash Ring	Stainless Steel	60
PRTR6X2SS	6" x 2" Trash Ring	Stainless Steel	30
PRTR6X6SS	6" x 6" Trash Ring	Stainless Steel	6
PRTR8X1SS	8" x 1" Trash Ring	Stainless Steel	60
PRTR8X2SS	8" x 2" Trash Ring	Stainless Steel	30

Grommets

## Grommets

### 3 Piece Grommet - Plastic



Diameter	Color	Part Number	Box Quantity
50mm	Almond	7342999039	100
50mm	Brown	7342993117	100
50mm	Black	7342993313	100
50mm	White	7342999735	100
60mm	Brown	7342999128	100
60mm	Black	7342999324	100
60mm	Almond	7342999020	100
60mm	White	7342999726	50
80mm	Black	7342999342	50
80mm	Almond	7342999048	50
80mm	Gray	7342999548	50
80mm	White	7342999744	50

### 2 Piece Grommet - Plastic



Diameter	Color	Part Number	Box Quantity
1 1/2"	Black	7342991037BK	100
1 3/4"	Black	7342993313M	100
2 1/2"	Brown	7342999128M	100
2 1/2"	Black	7342999324M	100
2 1/2"	Almond	7342999020M	100
2 1/2"	White	7342999726M	100
2 1/2"	Gray	7342999520M	100
3"	Black	7342999342M	100
3"	Almond	7342999048M	100
3"	Brown	7342999146M	100
3"	White	7342999744M	100

### Wire Grommet - Metal



Diameter	Color	Part Number	Box Quantity
40mm	Black	7342994310	50

Grommets/  
Locks



## Locks

### Cylinder Core



Part Number	Finish	Keys Available	Length	Box Quantity
7170CLCL1C0xx	Nickel	15	30mm	50
7170CLCL1CMIX	Nickel	Mixed	30mm	50
7170CLCL1C0xxBR	Brass	15	30mm	50
7170CLCL1C0xxBK	Black	15	30mm	50

Part Number	Description
7170CL1MK	CL1 Master Key
7170CL1RK	CL1 Removal Key

### Insertion of cylinder core.

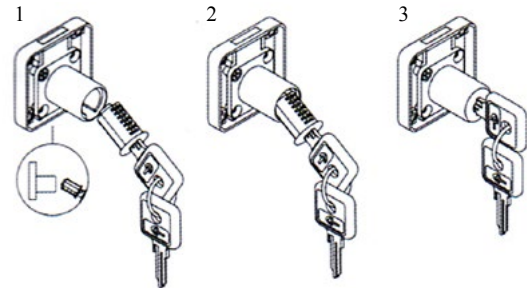

(lock must be in open position)

1 & 2: Install cylinder core with inserted key in the cylinder housing. (be sure to align the two diamond shaped objects on both - the cylinder core and the cylinder housing)

3: Apply light pressure until cylinder core snaps into place.

### Removal of cylinder core.

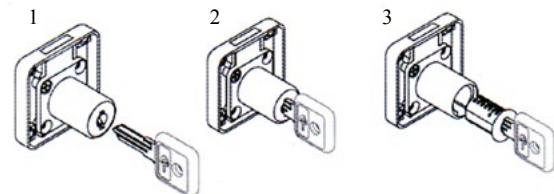

1 & 2: Insert removal key into cylinder core.

3: Remove cylinder core with removal key from cylinder housing.



## Locks

### Lock Housings

Cores Sold Separately



Cam Lock Housing

Square Drawer Lock Housing

Double Drawer Lock Housing

Push Lock Housing

Part Number	Finish	Type	Housing Length	Box Quantity
7170CLA6073001	Nickel	Cam Lock	30mm	50
7170CLA6073002	Brass	Cam Lock	30mm	50
7170CLA6073004	Black	Cam Lock	30mm	50
7170CLA60736501	Nickel	Cam Lock	36.5mm	50
7170CLA60744501	Nickel	Cam Lock	44.5mm	50
7170CLA6012201S	Nickel	Square Drawer Lock	22mm	50
7170CLA6012204S	Black	Square Drawer Lock	22mm	50
7170CLA6282201	Nickel	Double Drawer Lock	22mm	50
7170CLA6042201	Nickel	Push Lock	22mm	50
7170CLA6042202	Brass	Push Lock	22mm	50

### Gang Lock Housings

Cores Sold Separately



Part Number	Size	Keys Available	Finish	Box Quantity
7170CLA6022201C001	600mm	30	Nickel	50

### Cam Lock Hasp



Matte Nickel Finish  
Packed 25 per Box

Part Number: 7323517600

## Locks

### Lockclip

1/2" x 1 3/16" x 1/4" Lip  
Part Number: 7101C14



1/2" x 1 3/16" x 3/8" Lip  
Part Number: 7101C1426

Packed 1,000 per Box

### Strike Plate for Locks

Packed 500 per Box



Part Number: 7170RL3102NI

### H Mounting Bracket for Locks

Packed 500 per Box



Part Number: 7170CIT31205



## Pin Tumbler Locks - National Keyway

### 100DR Door Lock



Rekeyable.  
Barrel Diameter: 7/8"  
Includes: 56-1 bar strike.  
Available in Oil Rubbed Bronze  
and Satin Brass.

Part Number	Barrel Length	Key	Finish	Box Quantity
OL10026D78107	7/8"	KA107	Brushed Chrome	10
OL10026D78915	7/8"	KA915	Brushed Chrome	10
OL10026D78KD	7/8"	KD	Brushed Chrome	10

Locks

Pin Tumbler Locks - National Keyway

200DW Drawer Lock



Rekeyable.  
Barrel Diameter: 7/8"  
Includes: 56-1 bar strike.  
Available in Oil Rubbed Bronze  
and Satin Brass.

Part Number	Barrel Length	Key	Finish	Box Quantity
OL20026D78107	7/8"	KA107	Brushed Chrome	10
OL20026D78915	7/8"	KA915	Brushed Chrome	10
OL20026D78KD	7/8"	KD	Brushed Chrome	10
OL20026D138107	1 3/8"	KA107	Brushed Chrome	10
OL20026D138915	1 3/8"	KA915	Brushed Chrome	10
OL20026D138KD	1 3/8"	KD	Brushed Chrome	10

300SD Sliding Door Lock



Rekeyable.  
Barrel Length: 1"  
Barrel Diameter: 1"  
Includes: Bolt extender, strike locator, and strike sleeve.  
Available in Oil Rubbed Bronze  
and Bright Brass.

Part Number	Diameter	Key	Finish	Box Quantity
OL300SD26D78107	1"	KA107	Brushed Chrome	10
OL300SD26D78915	1"	KA915	Brushed Chrome	10
OL300SD26D78KD	1"	KD	Brushed Chrome	10

329R Showcase/Ratchet Lock



Rekeyable.  
Strap fits 1/4" material.

Part Number	For Material Thickness	Key	Finish	Box Quantity
OL329R26D915	1/4"	KA915	Brushed Chrome	10
OL329R26KD	1/4"	KD	Brushed Chrome	10

Locks

Pin Tumbler Locks - National Keyway

DCN Cam Locks



Rekeyable.  
Available in Oil Rubbed  
Bronze and Bright Brass.

Part Number	For Material Thickness	Key	Finish	Box Quantity
OLDCN126D915	3/4"	KA915	Brushed Chrome	10
OLDCN126DKD	3/4"	KD	Brushed Chrome	10
OLDCN426D915	1 1/2"	KA915	Brushed Chrome	10
OLDCN426DKD	1 1/2"	KD	Brushed Chrome	10

DCP Padlockable Cam Lock



Part Number	Barrel Length	Key	Finish	Box Quantity
OLDCPUS26	1 7/32"	N/A	Polished Chrome	10
OLDCP500US26	1 7/32"	With Pull	Polished Chrome	10

Locks

Spacers



WP21



WP22

Part Number	Thickness	Use With	Box Quantity
OLWP21	3/32"	100, 200, 500	100
OLWP22	1/4"	100, 200, 500	200

Locks

Strikes



1/2" Bar Strike  
White plastic  
Packed 100 per Box  
Part Number: OL10055



Angle Strike  
Brushed Chrome  
Packed 100 per Box  
Part Number: OL12326D



Heavy Duty Angle Strike  
Brushed Chrome  
Packed 200 per Box  
Part Number: OL12226D



Frameless Drawer Strike provides a locking point when there is no frame between drawers. Can be mounted on left or right side of cabinet frame.  
Packed 100 per Box  
Part Number: OL124ZP

National Keyway Cut Key

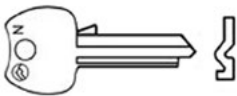

Cut master key for National GM2 (5-pin) master key system  
Packed 50 per Box  
Part Number: OLKBM2MKNP

Cascade Series Keys



Disc cut master key for Cascade Series  
Packed 50 per Box  
Part Number: OLKBD84EMK

Replacement key C415A for Cascade Series  
Packed 50 per Box  
Part Number: OLKBD85C415A

Cascade Series - Disc Tumbler Locks

953 Series



Part Number	Barrel Length	Key	Finish	Box Quantity
OL95314AC346A	1 3/16"	C346A	Bright Nickel	15
OL95314AC390A	1 3/16"	C390A	Bright Nickel	15
OL95314AC413A	1 3/16"	C413A	Bright Nickel	15
OL95314AC415A	1 3/16"	C415A	Bright Nickel	15
OL95314AC420A	1 3/16"	C420A	Bright Nickel	15
OL95314AC452A	1 3/16"	C452A	Bright Nickel	15
OL95314AD301	1 3/16"	MKKA301	Bright Nickel	15
OL95314AD302	1 3/16"	MKKA302	Bright Nickel	15
OL95314AD303	1 3/16"	MKKA303	Bright Nickel	15
OL95314AD304	1 3/16"	MKKA304	Bright Nickel	15
OL95314AD305	1 3/16"	MKKA305	Bright Nickel	15
OL95314AMKKD	1 3/16"	MKKD	Bright Nickel	15
OL95314AKD	1 3/16"	KD	Bright Nickel	15

Part Number	Barrel Length	Key	Finish	Box Quantity
OL953US19C346A	1 3/16"	C346A	Matte Black	15
OL953US19C390A	1 3/16"	C390A	Matte Black	15
OL953US19C413A	1 3/16"	C413A	Matte Black	15
OL953US19C415A	1 3/16"	C415A	Matte Black	15
OL953US19C452A	1 3/16"	C452A	Matte Black	15
OL953US19D301	1 3/16"	MKKA301	Matte Black	15
OL953US19D302	1 3/16"	MKKA302	Matte Black	15
OL953US19D303	1 3/16"	MKKA303	Matte Black	15
OL953US19MKKD	1 3/16"	MKKD	Matte Black	15
OL953US19KD	1 3/16"	KD	Matte Black	15

Cascade Series - Disc Tumbler Locks

954 Series



Part Number	Barrel Length	Key	Finish	Box Quantity
OL95414AC346A	15/16"	C346A	Bright Nickel	15
OL95414AC390A	15/16"	C390A	Bright Nickel	15
OL95414AC413A	15/16"	C413A	Bright Nickel	15
OL95414AC415A	15/16"	C415A	Bright Nickel	15
OL95414AC452A	15/16"	C452A	Bright Nickel	15
OL95414AKD	15/16"	KD	Bright Nickel	15
OL954US19C415A	15/16"	C415A	Matte Black	15
OL954US19KD	15/16"	KD	Matte Black	15

955 Series



Part Number	Barrel Length	Key	Finish	Box Quantity
OL95514AC415A	1 7/16"	C415A	Bright Nickel	15
OL95514AC452A	1 7/16"	C452A	Bright Nickel	15
OL95514AMKKD	1 7/16"	MKKD	Bright Nickel	15
OL95514AKD	1 7/16"	KD	Bright Nickel	15
OL955US19C415A	1 7/16"	C415A	Matte Black	15
OL955US19KD	1 7/16"	KD	Matte Black	15

Cascade Series - Disc Tumbler Locks

960 Series



Part Number	Barrel Length	Key	Finish	Box Quantity
OL96014AC346A	1 3/4"	C346A	Bright Nickel	15
OL96014AC390A	1 3/4"	C390A	Bright Nickel	15
OL96014AC413A	1 3/4"	C413A	Bright Nickel	15
OL96014AC415A	1 3/4"	C415A	Bright Nickel	15
OL96014AC420A	1 3/4"	C420A	Bright Nickel	15
OL96014AC452A	1 3/4"	C452A	Bright Nickel	15
OL96014AD301	1 3/4"	MKKA301	Bright Nickel	15
OL96014AD302	1 3/4"	MKKA302	Bright Nickel	15
OL96014AD303	1 3/4"	MKKA303	Bright Nickel	15
OL96014AD304	1 3/4"	MKKA304	Bright Nickel	15
OL96014AD305	1 3/4"	MKKA305	Bright Nickel	15
OL96014AMKKD	1 3/4"	MKKD	Bright Nickel	15
OL96014AKD	1 3/4"	KD	Bright Nickel	15
OL960US19C415A	1 3/4"	C415A	Matte Black	15
OL960US19MKKD	1 3/4"	MKKD	Matte Black	15
OL960US19KD	1 3/4"	KD	Matte Black	15

961 Series



Part Number	Barrel Length	Key	Finish	Box Quantity
OL96114AC415A	2"	C415A	Bright Nickel	15
OL96114AKD	2"	KD	Bright Nickel	15
OL961US19C415A	2"	C415A	Matte Black	15
OL961US19KD	2"	KD	Matte Black	15

## Hanging File Rods



Aluminum extruded rectangular.

Size	Part Number	Minimum Quantity
1/8" x 1/2" x 12 1/2"	710728128	1,000
1/8" x 1/2" x 13 29/32"	710728137	1,000
1/8" x 1/2" x 144"	710728144	50
1/8" x 3/4" x 144"	710738144	50

## Hanging File Rail



1/2" x 2.5 Meter  
Black color  
Packed 100 per Box

Part Number: 7108CPF32500

## Hanging File Fittings

**Kinetron Rigid Steel**  
For 1/2", 5/8", and 3/4"

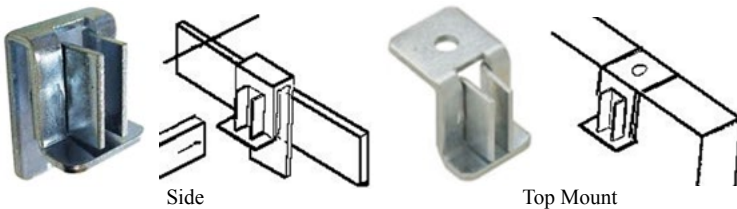

Side

Top Mount

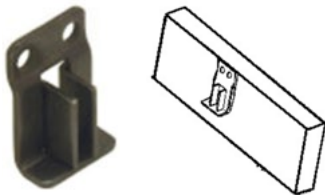

Face Mount

Rigid formed steel part.  
Use 1/8" x 1/2" rectangular rod.  
Zinc plated.

Type	Part Number	Box Quantity
1/2" Side	7108KHFB500	2,500
5/8" Side	7108KHFB625	2,000
3/4" Side	7108KHFB750	1,000
Face Mount	7108KHFBFM	500
Top Mount	7108KHFBTM	1,000



**Penda Lateral Bracket**  
Zinc plated.  
Packed 100 per Box  
Part Number: 7108KHFB18S

## LED Strip Lights

File Rods/  
Lighting



Dimensions: 12" x 45/64" x 13/32"  
18 LEDs offer 108 lumens at 2.8 watts

Dimensions: 16" x 45/64" x 13/32"  
25 LEDs offer 148 lumens at 2.88watts

- \*120 volt - No Transformer Needed
- \*Bulb life up to 30,000 hours
- \*Dimmable
- \*Up to 87% energy saving vs. halogen or xenon bulbs
- \*Cool to the touch
- \*Requires power cord, sold separately

Size	Part Number	Light	Color
12"	91DL1123W	Warm	White
12"	91DL1126W	Cool	White
16"	91DL1163W	Warm	White
16"	91DL1166W	Cool	White

## LED Under Cabinet Lights with 2-Way Switch



Dimensions: 16-11/16" x 2-19/64" x 1-1/64"  
56 LEDs offer 336 lumens at 4 watts  
Requires power cord, sold separately

Size	Part Number	Light	Color
16"	91DL2164W	Warm	White

## LED Connectors and Power Cords



555W



5601W

Part Number	Description	Color
91DL500W	Butt Connector	White
91DL512W	12" Connector	White
91DL536W	36" Connector	White
91DL555W	On/Off Connector w/4" + 4" Power Cord	White
91DL5601W	6' Power Cord with Switch	White
91DL5600W	6' Power Cord No Switch	White



LED Puck Lights



**Plastic Puck Light**  
 Surface mount ring diameter  
 2 3/4" (1 1/32" depth)  
 Recessed mount hole diameter  
 2 3/8" (1" depth)

**Metal Puck Light**  
 Surface mount ring diameter  
 2 3/4" (1" depth)  
 Recessed mount hole diameter  
 2 3/8" (3/4" depth)

- \*120 volt - No Transformer Needed
- \*Bulb life up to 30,000 hours
- \*Dimmable
- \*Up to 87% energy savings vs. halogen or xenon bulbs
- \*Cool to the touch
- \*Surface or recessed mounting hardware included
- \*Plastic 2.5 watt / Steel 1.8 watt
- \*80 Lumens
- \*Requires power cord, sold separately
- \* Link up to 10 lights in a series

Part Number	Type	Light	Color
91DL3703BK	Plastic	Warm	Black
91DL3706BK	Plastic	Cool	Black
91DL3703W	Plastic	Warm	White
91DL3706W	Plastic	Cool	White
91DL4703SN	Metal	Warm	Satin Nickel
91DL4706SN	Metal	Cool	Satin Nickel

Control Panel

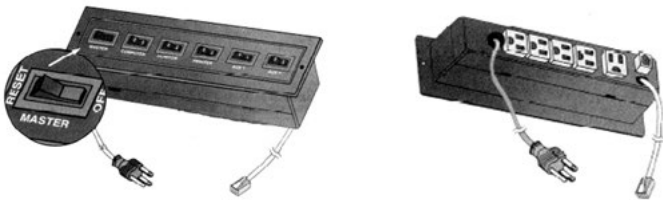

The illuminated master switch has an integrated circuit breaker with reset feature to provide overload and short circuit protection.

Voltage rating 120 Volt, 60 Hz, 13 Amp  
 10 foot black power cord, 14 foot phone cord.  
 5 receptacles and 1 phone jack.  
 Mounts with wood screws and spring clips.

Part Number: 90SLPCH543

Electrical Harnesses and Dimmers



Headboard Harness



Dimmer

Type	Cord Type	Part Number
Headboard Harness With 3-Way Switch	10' Male, 2-24" Female, Controlled by Rotary Dimmer, 2 Grounded Outlets, Telephone Jack Cable, and 3-Way Switch.	91101F24M3W
Touch Dimmer	10' Male 2-24" Female	913A



## Import Hardware

### Plastic Pulls



Part Number	Center to Center	Color	Box Quantity
7142C14599	96mm	Red	500
7142C1722CMG	96mm	Champagne	500
7142C4156976	76mm	Dark Gray	500
7142C9000	96mm	Black	500
7142C900076	76mm	Black	500
7142C91269	96mm	Almond	500
7142C91302	96mm	White	500
7142C9130276	76mm	White	500

### Metal Wire Pulls



Part Number	Center to Center	Color	Box Quantity
714233203B	3"	Polished Brass	50
714233203BB	3"	Brushed Brass	50
714233203C	3"	Polished Chrome	50
714233203BC	3"	Brushed Chrome	50
714233203MB	3"	Matte Black	50
714233204B	3 1/2"	Polished Brass	50
714233204C	3 1/2"	Polished Chrome	50
714233204	3 1/2"	Brushed Chrome	50
714233205B	96mm	Polished Brass	50
714233205BB	96mm	Brushed Brass	50
714233205C	96mm	Polished Chrome	50
714233205BC	96mm	Brushed Chrome	50
714233205MB	96mm	Matte Black	50
714233205BZ	96mm	Oil Rubbed Bronze	50
714233205SN	96mm	Satin Nickel	50
7142P355AL	4"	Aluminum	50
714233206C	4"	Polished Chrome	50
714233206BC	4"	Brushed Chrome	50
714233206MB	4"	Matte Black	50
714233207SC	5"	Satin Chrome	50

## Import Hardware

### Arch Pulls



Decorative  
Hardware

Part Number	Center to Center	Finish	Box Quantity
7142398696MB	96mm	Matte Black	50
7142398696SC	96mm	Satin Chrome	50
7142398696SN	96mm	Satin Nickel	50
71423986128MB	128mm	Matte Black	50
71423986128PC	128mm	Polished Chrome	50
71423986128SC	128mm	Satin Chrome	50
71423986128SN	128mm	Satin Nickel	50
71423986160MB	160mm	Matte Black	50
71423986160SC	160mm	Satin Chrome	50
71423986224SN	224mm	Satin Nickel	50

### Bow Pulls



Part Number	Center to Center	Finish	Box Quantity
AM53003FB	96mm	Flat Black	25
AM53003G10	96mm	Satin Nickel	25
AM53003ORB	96mm	Oil Rubbed Bronze	25
7141P7166SN	96mm	Satin Nickel	50

### Narrow Bow Pulls



Part Number	Center to Center	Finish	Box Quantity
7141P4655BK	128mm	Black	50
7141P4655SN	128mm	Satin Nickel	50

## Import Hardware

### Bar Pulls

Decorative  
Hardware



Part Number	Overall Length	Center to Center	Finish	Box Quantity
7141P104SN	115mm	64mm	Satin Nickel	100
7141P1096BK	152mm	96mm	Matte Black	100
7141P109610B	152mm	96mm	Oil Rubbed Bronze	100
7141P1096SN	152mm	96mm	Satin Nickel	100
7141P106BK	6"	3"	Matte Black	100
7141P10610B	6"	3"	Oil Rubbed Bronze	100
7141P106SN	6"	3"	Satin Nickel	100
7141P108BK	8"	5"	Matte Black	50
7141P10810B	8"	5"	Oil Rubbed Bronze	50
7141P108SN	8"	5"	Satin Nickel	50
7141P11010B	10"	7"	Oil Rubbed Bronze	50
7141P110SN	10"	7"	Satin Nickel	50
7141P11210B	12"	9"	Oil Rubbed Bronze	50
7141P112SN	12"	9"	Satin Nickel	50
7141P114SN	14"	11"	Satin Nickel	30
7141P11610B	16"	13"	Oil Rubbed Bronze	30
7141P116SN	16"	13"	Satin Nickel	30
7141P118SN	18"	15"	Satin Nickel	30
7141P12010B	20"	17"	Oil Rubbed Bronze	30
7141P120SN	20"	17"	Satin Nickel	30
7141P122SN	22"	19"	Satin Nickel	20
7141P12410B	24"	21"	Oil Rubbed Bronze	20
7141P124SN	24"	21"	Satin Nickel	20
7141P126SN	26"	23"	Satin Nickel	20
7141P128SN	28"	25"	Satin Nickel	20
7141P130SN	30"	27"	Satin Nickel	20

\*Some Sizes Available in Polished Chrome and Rose Gold.

### Bar Knobs



2 Inch Bar Knob  
Satin Nickel  
Packed 100 per Box  
Part Number: 7141K102SN

## Import Hardware

### Modern Square Pulls



Part Number	Center to Center	Finish	Box Quantity
7141P87226SN	96mm	Satin Nickel	250
7141P87227SN	128mm	Satin Nickel	250
7141P87228SN	160mm	Satin Nickel	250
7141P87229SN	192mm	Satin Nickel	250
7141P87300SN	224mm	Satin Nickel	250
7141P87328SN	320mm	Satin Nickel	250

\*Some sizes available in Matte Black, Oil Rubbed Bronze, Polished Chrome, Rose Gold and Satin Nickel.

### Die Cast Waterfall Pulls



Part Number	Center to Center	Overall Length	Finish	Box Quantity
7141P80846BK	96mm	6 3/4"	Black	250
7141P80846SN	96mm	6 3/4"	Satin Nickel	250

### Die Cast Hollow Pulls



3 Inch Center Pull  
Polished Brass  
Packed 500 per Box  
Part Number: 7141P0048PB

### Plastic Pulls



Part Number	Center to Center	Color	Box Quantity
71421420B3740	4"	Black	100
71421420G3740	4"	Gray	100



## Import Hardware Football Knobs



Part Number	Size	Type	Finish	Box Quantity
7141K8399010B	1 1/4"	Solid	Oil Rubbed Bronze	250
7141K83990SN	1 1/4"	Solid	Satin Nickel	250
7141K8399110B	1 5/8"	Solid	Oil Rubbed Bronze	250
7141K83991DACM	1 5/8"	Solid	Weathered Black	250
7141K83991SN	1 5/8"	Solid	Satin Nickel	250

## Die Cast Knobs



Part Number	Diameter	Finish	Box Quantity
71412551DAB	1 1/4"	Dark Antique Brass	100
71412551SN	1 1/4"	Satin Nickel	100



1 5/16 Inch Diameter Knob  
Antique Brass  
Packed 500 per Box  
Part Number: 7141875AB

## Mushroom Die Cast Knobs



Part Number	Diameter	Finish	Box Quantity
7141K910AB	30mm	Antique Brass	250
7141K910BK	30mm	Matte Black	250
7141K910BN	30mm	Black Nickel	250
7141K910DACM	30mm	Weathered Black	250
7141K910ORB	30mm	Oil Rubbed Bronze	250
7141K910PC	30mm	Polished Chrome	250
7141K910SC	30mm	Satin Chrome	250
7141K910SN	30mm	Satin Nickel	250

## Import Hardware Porcelain Knobs



1 1/4 Inch Diameter Knob  
White  
Packed 25 per Box  
Part Number: 7141P28W

Decorative  
Hardware

## Plastic Knobs



Part Number	Diameter	Color	Box Quantity
7142H894AL	1 1/2"	Almond	500
7142H894BK	1 1/2"	Black	500
7142H894WH	1 1/2"	White	500

## Birch Knob Without Insert



1 1/2 Inch Diameter Knob  
Natural  
Without Insert  
Packed 2,000 per Box  
Part Number: 7140KR150

## Flush Sliding Pulls



3/4 Inch Diameter, 3/8 Inch Deep - Zinc  
Packed 100 per Box  
Part Number: 7141365Z

## Mission Pull



Mission Pull - Black  
Packed 250 per Box  
Part Number: 7141ILP1011BK

## Import Hardware

Decorative  
Hardware



### T-Knob

45mm T-Knob  
Packed 250 per Box  
Black Part Number: 7141K8026BK  
Satin Nickel Part Number: 7141K8026SN

### Knobs



1 1/8 Inch Diameter Knob  
Satin Nickel  
Packed 600 per Box  
Part Number: 7141T118SN



1 3/8 Inch Diameter Knob  
Matte Brown  
Packed 800 per Box  
Part Number: 714198801MBR



Part Number	Diameter	Finish	Box Quantity
7141K8098010B	32mm	Oil Rubbed Bronze	250
7141K80980SN	32mm	Satin Nickel	250

### Football Knob



1 1/4 Inch Diameter Football Knob  
Oil Rubbed Bronze  
Packed 400 per Box  
Part Number: 71419933BZ

### Square Knobs



Part Number	Size	Finish	Box Quantity
71411615BZ	1 1/4"	Bronze	320
71411615SN	1 1/4"	Satin Nickel	320

## Import Hardware

### Deco Knobs



Part Number	Diameter	Finish	Box Quantity
7141K80960SN	32mm	Satin Nickel	250

\*Available in Antique Satin Brass, Oil Rubbed Bronze, Satin Nickel, Satin Pewter and Weathered Black.



Part Number	Diameter	Finish	Box Quantity
7141K97110B	1 3/8"	Oil Rubbed Bronze	250
7141K971BNMDL	1 3/8"	Weathered Nickel	250
7141K971SN	1 3/8"	Satin Nickel	250

\*Available in Antique Brass Polished, Antique Copper, Antique English Polished, Antique Silver, Black Nickel, Oil Rubbed Bronze, Satin Nickel and Weathered Nickel

### Deco Pulls



Part Number	Center to Center	Finish	Box Quantity
7141P8028110B	96mm	Oil Rubbed Bronze	250
7141P80281SN	96mm	Satin Nickel	250

\*Available in Oil Rubbed Bronze, Satin Nickel, Satin Pewter and Weathered Black.



## Import Hardware Charlotte Square Knobs



Part Number	Size	Finish	Box Quantity
7141K81091DACM	32mm	Weathered Black	250
7141K8109110B	32mm	Oil Rubbed Bronze	250
7141K81091SN	32mm	Satin Nickel	250

\*Available in Antique Satin Brass, Matte Black, Oil Rubbed Bronze, Polished Chrome, Rose Gold, Satin Nickel, Satin Pewter and Weathered Black.

## Charlotte Pulls



Part Number	Center to Center	Finish	Box Quantity
7141P8109210B	96mm	Oil Rubbed Bronze	250
7141P8209210B	128mm	Oil Rubbed Bronze	250
7141P8309210B	160mm	Oil Rubbed Bronze	250

\*Some sizes available in Antique Satin Brass, Matte Black, Oil Rubbed Bronze, Polished Chrome, Rose Gold, Satin Nickel, Satin Pewter and Weathered Black.

## Cup Pulls



2 1/2 Inch Center Cup Pull  
Satin Nickel  
Packed 100 per Box  
Part Number: 7141JC212SN

3 Inch Center Cup Pull  
Satin Nickel  
Packed 250 per Box  
Part Number: 7141P8233SN

\*Available in Oil Rubbed Bronze and Matte Black.

## Import Hardware Cup Pulls



Decorative  
Hardware

Part Number	Center to Center	Finish	Box Quantity
7141P80753SN	3"	Satin Nickel	250

\*Available in Antique Satin Brass, Matte Black, Oil Rubbed Bronze, Polished Chrome, Rose Gold, Satin Nickel, Satin Pewter and Weathered Black

## Colorado Knobs



Part Number	Size	Finish	Box Quantity
7141K92925BK	32mm Round	Matte Black	250

\*Available in Dark Pewter, Matte Black, Oil Rubbed Bronze, Polished Chrome, Rose Gold, and Satin Nickel.



Part Number	Size	Finish	Box Quantity
7141K94723BK	30mm Square	Matte Black	250

\*Available in Dark Pewter, Matte Black, Oil Rubbed Bronze, Polished Chrome, Rose Gold, and Satin Nickel.

## Colorado Pulls



Part Number	Center to Center	Finish	Box Quantity
7141P92836BK	96mm	Matte Black	250
7141P92837BK	128mm	Matte Black	250
7141P92838BK	160mm	Matte Black	250

\*Available in Dark Pewter, Matte Black, Oil Rubbed Bronze, Polished Chrome, Rose Gold, and Satin Nickel.

## Import Hardware Miami Square Knobs



Part Number	Size	Finish	Box Quantity
7141K83125BK	1"	Matte Black	250

\*Available in Matte Black, Oil Rubbed Bronze, Polished Chrome, Rose Gold and Satin Nickel.

## Miami Pulls



Part Number	Center to Center	Finish	Box Quantity
7141P80572BK	96mm	Matte Black	250
7141P81572BK	128mm	Matte Black	250
7141P83572BK	160mm	Matte Black	250

\*Available in Matte Black, Oil Rubbed Bronze, Polished Chrome, Rose Gold and Satin Nickel.

## Edge Pulls



Part Number	Center to Center	Finish	Box Quantity
7141P1803BK	3"	Matte Black	250
7141P1806BK	6"	Matte Black	250
7141P1809BK	9"	Matte Black	250
7141P1812BK	12"	Matte Black	250

\*Available in Matte Black, Polished Chrome and Satin Nickel.

## Import Hardware Modern Pulls



Part Number	Center to Center	Finish	Box Quantity
7141P82234SN	96mm	Satin Nickel	250
7141P82034SN	128mm	Satin Nickel	250
7141P81235SN	160mm	Satin Nickel	250

\*Available in Matte Black, Oil Rubbed Bronze, Polished Chrome and Satin Nickel.





# BLACKROCK

Decorative Hardware



AM55278G10  
160mm Center Pull  
Satin Nickel



AM55277BBR  
128mm Center Pull  
Black Bronze



AM55272G10  
1 5/8 Inch Diameter Knob  
Satin Nickel



AM55270BBR  
34mm Diameter Knob  
Black Bronze



AM55274BBZ  
1 Inch Pendant Knob  
Golden Champagne



AM55273G10  
1 1/2 Inch Square Knob  
Satin Nickel



AM55271BBR  
1 Inch Square Knob  
Black Bronze



AM55275G10  
3 Inch Center Pull  
Satin Nickel



AM55276CZ  
96mm Center Pull  
Champagne Bronze

All styles are available in -26 Polished Chrome, -BBR Black Bronze, -BBZ Golden Champagne, -CZ Champagne Bronze, -G10 Satin Nickel, -GN Gunmetal, -ORB Oil Rubbed Bronze and -PN Polished Nickel.

# CANDLER



AM29363G10  
128mm Center Pull  
Satin Nickel



AM29364BBZ  
160mm Center Pull  
Golden Champagne



AM29355BBR  
96mm Center Pull  
Black Bronze



AM29349G10  
3 Inch Center Pull  
Satin Nickel



AM29368BBZ  
1 1/2 Inch Knob  
Golden Champagne



AM29340BBR  
1 1/4 Inch Knob  
Black Bronze

All styles are available in -AS Antique Silver, -BBR Black Bronze, -BBZ Golden Champagne, -CZ Champagne Bronze, -G10 Satin Nickel, -GM Gunmetal, -ORB Oil Rubbed Bronze, and -PN Polished Nickel.







## MONUMENT

Decorative Hardware



AM36905BBZ  
1 3/16 Inch Square Knob  
Golden Champagne



AM36570CZ  
96mm Center Pull  
Champagne Bronze



AM36571FB  
128mm Center Pull  
Matte Black



AM36572G10  
160mm Center Pull  
Satin Nickel

All styles are available in -BBZ Golden Champagne, -CZ Champagne Bronze, -FB Matte Black, -G10 Satin Nickel, -ORB Oil Rubbed Bronze and -PN Polished Nickel.

## RIVA



AM55365G10  
1 1/4 Inch Diameter Knob  
Satin Nickel



AM55364GPH  
3 Inch Center Pull  
Graphite



AM55365G10  
96mm Center Pull  
Satin Nickel



AM55367BBZ  
128mm Center Pull  
Golden Champagne



AM55368FB  
160mm Center Pull  
Matte Black

All styles are available in -26 Polished Chrome, -BBZ Golden Champagne, -FB Matte Black, -G10 Satin Nickel, -GPH Graphite, and -PN Polished Nickel.

## VERSA



AM36912FB  
96mm Center Pull  
Matte Black

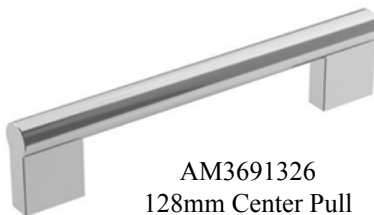

AM3691326  
128mm Center Pull  
Polished Chrome



AM36914G10  
160mm Center Pull  
Satin Nickel



AM36915CZ  
224mm Center Pull  
Champagne Bronze



AM36904G10  
1 3/8 Inch Diameter Knob  
Satin Nickel

All styles are available in -26 Polished Chrome, -CZ Champagne Bronze, -FB Matte Black, and -G10 Satin Nickel,





## EXTENSITY

Decorative  
Hardware



AM29394ORB  
160mm Center Pull  
Oil Rubbed Bronze

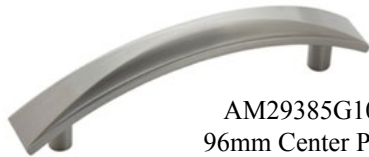

AM29385G10  
96mm Center Pull  
Satin Nickel



AM29379CZ  
3 Inch Center Pull  
Champagne Bronze



AM29398G10  
1 1/2 Inch Knob  
Satin Nickel



AM29393AS  
128mm Center Pull  
Antique Silver

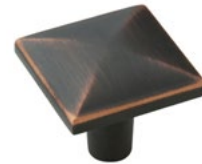

AM29370ORB  
1 3/16 Inch Knob  
Oil Rubbed Bronze

Some styles are available in -26 Polished Chrome, -AS Antique Silver, -CZ Champagne Bronze, -FB Matte Black, -G10 Satin Nickel and -ORB Oil Rubbed Bronze.

## WESTERLY



AM53717G10  
1 5/16 Inch T Knob  
Satin Nickel



AM53718GPH  
1 3/16 Inch Diameter Knob  
Graphite



AM53720BBR  
96mm Center Pull  
Black Bronze



AM53721G10  
128mm Center Pull  
Satin Nickel

All styles are available in -G10 Satin Nickel, -BBR Black Bronze, -BBZ Golden Champagne and -GPH Graphite.

## INSPIRATIONS



AM1585FB  
1 1/4 Inch Diameter Knob  
Flat Black



AM1584G10  
3 Inch Center Pull  
Satin Nickel



AM1586ORB  
1 3/8 Inch Diameter Knob  
Oil Rubbed Bronze



AM1590WN  
3 Inch Center Pull  
Weathered Nickel



AM1590WID  
3 Inch Center Pull  
Wrought Iron Dark

Some styles are available in -FB Flat Black, -G10 Satin Nickel, -ORB Oil Rubbed Bronze and -WN Weathered Nickel.





## KANE

Decorative  
Hardware



AM538072G10  
1 5/8 Inch Diameter Knob  
Satin Nickel



AM53802BBR  
128mm Center Pull  
Black Bronze



AM53700WN  
1 1/4 Inch Diameter Knob  
Weathered Nickel



AM53702ORB  
96mm Center Pull  
Oil Rubbed Bronze



AM53701BBZ  
3 Inch Center Pull  
Golden Champagne



AM53801ORB  
96mm Center Pull  
Oil Rubbed Bronze

All styles are available in -G10 Satin Nickel, -AS Antique Silver, -BBR Black Bronze, -BBZ Golden Champagne, -ORB Oil Rubbed Bronze, -PN Polished Nickel, and -WN Weathered Nickel.

## ABERNATHY & TRADITIONAL CLASSICS



AM29460CG10  
1 1/16 Inch Square Knob  
Clear/Satin Nickel



AM55266CG10  
1 1/16 Inch Diameter Knob  
Clear/Satin Nickel



AM55268CPN  
1 5/16 Inch Diameter Knob  
Clear/Polished Nickel

## MULHOLLAND



AM53029G10  
1 1/4 Inch Knob  
Satin Nickel



AM53030BBZ  
3 Inch Center Pull  
Golden Champagne



AM53529BBR  
128mm Center Pull  
Black Bronze



AM53530PN  
160mm Center Pull  
Polished Nickel



AM53031GM  
96mm Center Pull  
Gunmetal

Some styles are available in -26 Polished Chrome, -BBR Black Bronze, -BBZ Golden Champagne, -G10 Satin Nickel, -GB Gilded Bronze, -GM Gunmetal and -ORB Oil Rubbed Bronze.





## ESQUIRE

Decorative  
Hardware



AM36556PNBBR  
67mm T Knob  
Polished Nickel/Black Bronze



AM36557G10ORB  
3 Inch & 3 3/4 Inch Center Pull  
Satin Nickel/Oil Rubbed Bronze



AM36558PNGM  
128mm Center Pull  
Polished Nickel/Gunmetal



AM36559PNBBR  
160mm Center Pull  
Polished Nickel/Black Bronze



AM36560PNGM  
256mm Center Pull  
Polished Nickel/Gunmetal



AM36561G10ORB  
320mm Center Pull  
Satin Nickel/Oil Rubbed Bronze

All styles are available in -G10ORB Satin Nickel/Oil Rubbed Bronze, -PNBBR Polished Nickel/Black Bronze, -PNBBZ Polished Nickel/Golden Champagne, -PNGM Polished Nickel/Gunmetal and -PNSS Polished Nickel/Stainless Steel.

## REVITALIZE



AM55342G10  
1 1/4 Inch Diameter Knob  
Satin Nickel



AM55346G10  
128mm Center Pull  
Satin Nickel



AM55344BBZ  
96mm Center Pull  
Golden Champagne



AM55341ORB  
1 1/4 Inch Diameter Knob  
Oil Rubbed Bronze



AM55340BBZ  
1 1/4 Inch Rectangle Knob  
Golden Champagne



AM55343BBR  
3 Inch Center Pull  
Black Bronze

Some styles are available in -BBR Black Bronze, -BBZ Golden Champagne, -G10 Satin Nickel, -GB Gilded Bronze, -GM Gunmetal, -ORB Oil Rubbed Bronze and -PN Polished Nickel.

## GRACE REVITALIZE



AM36628BBZ  
1 3/8 Inch Diameter Knob  
Golden Champagne



AM36629PN  
1 3/4 Inch Diameter Knob  
Polished Nickel

All styles are available in -BBR Black Bronze, -BBZ Golden Champagne, -G10 Satin Nickel, -ORB Oil Rubbed Bronze, and -PN Polished Nickel.



## CYPRUS

Decorative  
Hardware



AM26201BBZ  
3 Inch Center Pull  
Golden Champagne



AM26203BBZ  
96mm Center Pull  
Golden Champagne



AM26204G10  
160mm Center Pull  
Satin Nickel



AM9362G10  
128mm Center Pull  
Satin Nickel

All styles are available in -BBR Black Bronze, -BBZ Golden Champagne, -G10 Satin Nickel, -ORB Oil Rubbed Bronze and -PN Polished Nickel.

## EDGE PULLS

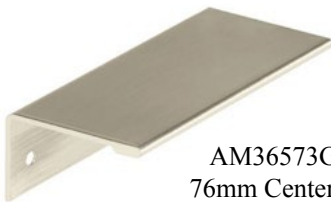

AM36573G10  
76mm Center Pull  
Satin Nickel

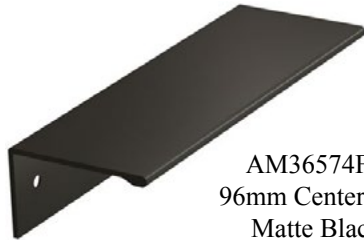

AM36574FB  
96mm Center Pull  
Matte Black

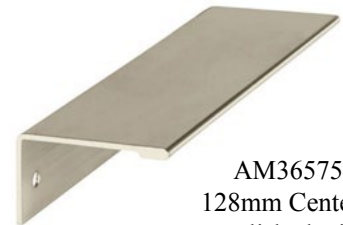

AM36575PN  
128mm Center Pull  
Polished Nickel

All styles are available in -26 Polished Chrome, -FB Matte Black, -G10 Satin Nickel, -ORB Oil Rubbed Bronze and -PN Polished Nickel.

## BAR PULLS



AM40515CZ  
3 Inch Center Pull  
Champagne Bronze



AM40516ORB  
96mm Center Pull  
Oil Rubbed Bronze



AM4051726  
128mm Center Pull  
Polished Chrome



AM40518BBR  
192mm Center Pull  
Black Bronze



AM40519CZ  
256mm Center Pull  
Champagne Bronze

Some styles are available in -26 Polished Chrome, -BBR Black Bronze, -BBZ Golden Champagne, -CZ Champagne Bronze, -GM Gunmetal, -ORB Oil Rubbed Bronze and -PN Polished Nickel.





# STAINLESS STEEL

Decorative  
Hardware



AM19008SS  
1 1/4 Inch Diameter Knob  
Stainless Steel



AM19009SS  
1 1/4 Inch T-Knob  
Stainless Steel



AM19010SS  
3 Inch Center Pull  
Stainless Steel



AM19011SS  
96mm Center Pull  
Stainless Steel



AM19012SS  
192mm Center Pull  
Stainless Steel



AM19013SS  
256mm Center Pull  
Stainless Steel



AM19014SS  
320mm Center Pull  
Stainless Steel



AM19015SS  
416mm Center Pull  
Stainless Steel



AM19016SS  
480mm Center Pull  
Stainless Steel



AM19017SS  
544mm Center Pull  
Stainless Steel



AM19018SS  
640mm Center Pull  
Stainless Steel



AM19019SS  
768mm Center Pull  
Stainless Steel

Ask about our CSG9 Steel/Sterling Nickel finish for the pulls above.





## GRANBY



AM55244ORB  
128mm Center Pull  
Oil Rubbed Bronze



AM55243G10  
96mm Center Pull  
Satin Nickel



AM53013ORB  
3 Inch Center Pull  
Oil Rubbed Bronze

Some styles are available in -26 Polished Chrome, -BN Black Nickel, -FB Matte Black, -G10 Satin Nickel, and -ORB Oil Rubbed Bronze.

## EVERYDAY HERITAGE



AM5301226  
1 1/4 Inch Diameter Knob  
Polished Chrome



AM53003ORB  
96mm Center Pull  
Oil Rubbed Bronze



AM53005ORB  
1 1/4 Inch Diameter Knob  
Oil Rubbed Bronze



AM53002ORB  
1 3/16 Inch Diameter Knob  
Oil Rubbed Bronze



AM53014ORB  
1 3/8 Inch Oval Knob  
Oil Rubbed Bronze



AM29113G10  
1 1/4 Inch Diameter Knob  
Satin Nickel



AM53015ORB  
1 1/4 Inch Diameter Knob  
Oil Rubbed Bronze



AM53011ORB  
1 1/4 Inch Diameter Knob  
Oil Rubbed Bronze



AM53010G10  
3 Inch Center Cup Pull  
Satin Nickel

Some styles are available in -26 Polished Chrome, -FB Matte Black, -G10 Satin Nickel and -ORB Oil Rubbed Bronze





# APPLIANCE PULLS

Decorative  
Hardware



AM55280BBR  
Blackrock  
12 Inch Center Appliance Pull  
Black Bronze



AM53806WN  
Kane  
18 Inch Center Appliance Pull  
Weathered Nickel



AM26205BBZ  
Cypress  
8 Inch Center Appliance Pull  
Golden Champagne



AM29366AS  
Candler  
12 Inch Center Appliance Pull  
Antique Silver

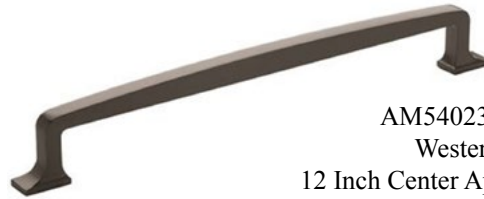

AM54023GPH  
Westerly  
12 Inch Center Appliance Pull  
Graphite



AM53532BBZ  
Mulholland  
12 Inch Center Appliance Pull  
Golden Champagne



AM29397G10  
Extensity  
18 Inch Center Appliance Pull  
Satin Nickel

More Appliance Pulls are available please contact us for more information.





## Bravo

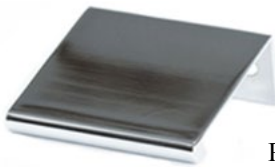

BE10534026  
1 3/4 Inch Pull  
Polished Chrome



BE10524BPN  
1 3/4 Inch Pull  
Brushed Nickel

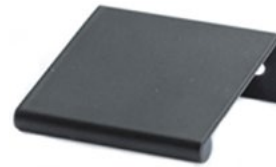

BE10564055  
1 3/4 Inch Pull  
Satin Black



BE10584026  
3 Inch Pull  
Polished Chrome



BE10574BPN  
3 Inch Pull  
Brushed Nickel



BE10604055  
3 Inch Pull  
Satin Black



BE10624026  
6 Inch Pull  
Polished Chrome



BE10614BPN  
6 Inch Pull  
Brushed Nickel



BE10644055  
6 Inch Pull  
Satin Black

## Skyline



BE11251SLT  
1 3/8 Inch T Knob  
Slate



BE11211SLT  
3"/96mm Center Pull  
Slate



BE11221SLT  
160mm Center Pull  
Slate



BE11231SLT  
224mm Center Pull  
Slate



BE99781MDB  
224mm Center Pull  
Modern Bronze



BE99771MDB  
160mm Center Pull  
Modern Bronze



BE99761MDB  
3"/96mm Center Pull  
Modern Bronze



BE99951MDB  
1 3/8 Inch T Knob  
Modern Bronze



BE92101026  
1 3/8 Inch T Knob  
Polished Chrome



BE92011026  
3"/96mm Center Pull  
Polished Chrome



BE92041026  
160mm Center Pull  
Polished Chrome



BE92071026  
224mm Center Pull  
Polished Chrome



## Elevate

Decorative  
Hardware



BE20854BPN  
96mm Center Pull  
Brushed Nickel



BE20874BPN  
128mm Center Pull  
Brushed Nickel



BE20894BPN  
160mm Center Pull  
Brushed Nickel



BE2172BPN  
1 3/16 Inch Square Knob  
Brushed Nickel

Available in Brushed Nickel, Graphite, Matte Black, Polished Chrome, Satin Gold and Verona Bronze.

## Designers' Group 10



BE41401014  
96mm Center Pull  
Polished Nickel



BE41411014  
6 Inch Center Pull  
Polished Nickel



BE41441014  
96mm Center Pull  
Polished Nickel



BE41421014  
1 9/16 L x 1 1/8 W Inch Knob  
Polished Nickel



BE41501014  
31mm Diameter Knob  
Polished Nickel



BE41521014  
1 3/8 Inch Diameter Knob  
Polished Nickel

## Aspire



BE92311BPN  
96mm Center Pull  
Brushed Nickel



BE92341BPN  
128mm Center Pull  
Brushed Nickel



BE92371BPN  
160mm Center Pull  
Brushed Nickel



BE92431BPN  
1 1/4 L x 3/4 W Inch Knob  
Brushed Nickel



BE92401BPN  
12 Inch Center Pull  
Brushed Nickel

# EMTEK<sup>®</sup>

## ASSA ABLOY

We offer Emtek by Special Order only.  
Below are some Emtek boards displaying their knobs and pulls.  
Please contact U.S. Industrial Fasteners for pricing and availability.

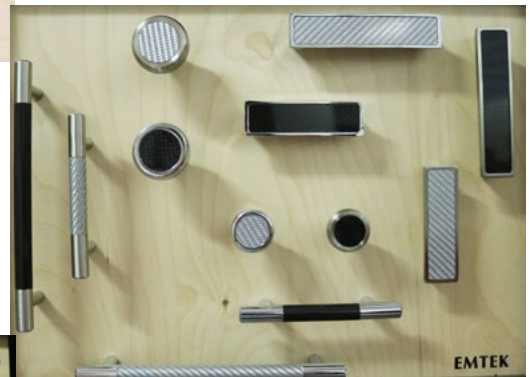
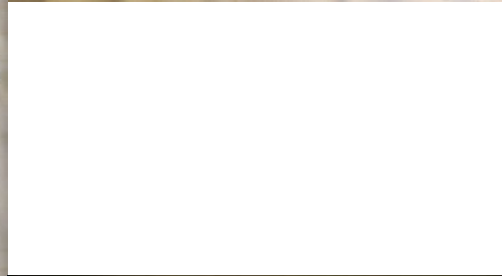



We offer Schaub by Special Order only.  
 Below are some Schaub boards displaying their knobs and pulls.  
 Please contact U.S. Industrial Fasteners for pricing and availability.



Italian Contemporary Board



Menlo Park Board



Sorrento Board



Traditional Board



City Lights and Stargaze Board



Atherton Board





We offer Top Knobs by Special Order only.  
Please visit their website at [www.topknobs.com](http://www.topknobs.com) to see more.  
Please contact U.S. Industrial Fasteners for pricing.





## Fastcap and Fastedge Colors & Materials

Fastcap

Product Type	Code
Fastcap	FC
Fastedge	FE

### PVC (Solids & Woodgrains) 7208\*\*\*\*



Fastcap Packaging	Quantity
Mini Box (MB)	5 Sheets (260 9/16" caps)
Standard Box	20 Sheets (1,040 9/16" caps)

Fastedge Packaging
50 foot roll
250 foot roll

Description	Cap Type	Code
<b>Round</b>	3/8" (9mm)	3/8
	7/16" (11mm)	716
	1/2" (13mm)	1/2
	9/16" (14mm)	916
	5/8" (15mm)	5/8
	11/16" (18mm)	18mm
	1" (25mm)	1
	1 1/4" (32mm)	1-1/4
	1 5/8" (42mm)	1-5/8
	2 1/4" (57mm)	2-1/4
3" (76mm)	3	
3 1/2" (89mm)	3-1/2	
<b>Plumbing</b>	1/2" Supply Lines and 1 1/2" Waste Lines	P1
	1/2" Supply Line	P2
	1/2" Supply Lines and 2 7/16" Waste Lines	P3
	1/2" Supply Lines and 2 11/16" Waste Lines	P4
	5x5 Patch	P5
<b>Electrical</b>	Electrical Trim Box	E1
	Double Gang Box	E2 (white only)
<b>Cabinetry</b>	Kreg Tool Cap	KC
	Castle Cap	CC
	Par Cap (4")	PAR4
	Par Cap (5 1/2")	PAR5
	Hinge Cover Cap	H2.5
	Knockdown Cap	KD
	Rafix 1	RAFIX1
	Rafix 2	RAFIX2
	RTA 1	RTA1
	RTA 2	RTA2
<b>Misc.</b>	Phone Pads	PP
	Fastpad	FP (smooth white)
	Hood Cap	9" (white only)
	Kaizen Caps	SSSM/SSMD/SSLG

### Prefinished (Real Wood) 7210\*\*\*\*



### Unfinished (Real Wood) 7209\*\*\*\*



Woodgrain will vary on the Real Wood Fastcaps.



## SpeedTape

Fastcap



Double Sided Transfer Tape

SpeedTape™ is FastCap's high performance ultra-bond adhesive in a peel and stick roll! Apply SpeedTape to almost anything you want to stick in place. Peel off the liner and stick it. If you have a peel and stick application, SpeedTape is The Answer.

**Features...**

- \* Available in 50' rolls and 9 widths
- \* Strengthens as it cures
- \* Double-sided PSA adhesive

**Great for...**

- \* Edging/Laminates
- \* Jigs for templates
- \* General adhesives

Part Number	Description
88FCSTAPE1	1" x 50' SpeedTape
88FCSTAPE2	2" x 50' SpeedTape
88FCTAPE65	6.5" x 50' SpeedTape

\*Other widths are available 1/16" - 15" by Special Order. Please contact U.S. Industrial for more information.

## SpeedRoller PRO



The SpeedRollerPRO™ is an ergonomic laminate roller that can be used for any PSA application - especially FastEdge & SpeedTape. The SpeedRollerPRO includes 2 sets of interchangeable wheels.

**Features...**

- \* Ergonomic shape
- \* Non-marring rubber wheels
- \* Maximum PSA steel wheels

**Great for...**

- \* Roll on Fastedge
- \* Roll on SpeedTape
- \* Labels and laminate

Part Number	Description
88FCSPEEDROLLER	SpeedRoller Pro



## Quad Trimmer



The Pneumatic Quad Trimmer™ with Carbon Steel or Tungsten Carbide Blades make trimming edgbanding quick and easy! With a comfortable and ergonomic design, it trims both of the edgbanding in just one pass.

**Features...**

- \* No springs, all pneumatic
- \* Cuts forwards and backwards
- \* Cuts both sides at once

**Great for...**

- \* Edgbanding
- \* Wood veneer
- \* Materials up to .018

Part Number	Description
88FCQTRIM	Quad Trimmer with Carbon Steel Blades
88FCQPROTRIM	Quad Pro Trimmer with Tungsten Carbide Blades
88FCQBLADE	Carbon Steel Blade Replacements
88FCQPROBLADE	Tungsten Carbide Blade Replacements

## FlushMount Drill Bit System



The FlushMount Drill Bit System™ incorporates a unique ball bearing stop collar that controls the recess depth of the drill and allows the stop collar to stop spinning when it comes in contact with the surface.

**Features...**

- \* Carbide cutter 3/8" and 9/16"
- \* Micro depth adjustment
- \* Adjustable 1/8" pilot bit

**Great for...**

- \* Countersinking Fastcaps
- \* Countersink PowerHead Screws
- \* Recessing magnets

Part Number	Description
88FCDBC916MICRO	FlushMount System with 9/16" Cutter
88FCDB3/8	3/8" Carbide Cutter
88FCDBMCINNERBIT	Inner Bit Replacement



### Custom Color Punch Kit



### Custom Color Hole Punch Kit



- \* Hard shell case
- \* 1" x 50' SpeedTape
- \* 3/8", 9/16" and 18mm die
- \* Hole Punch Tool
- \* PowerHead Screws
- \* FlushMount Drill Bit System

### Custom Color Hole Punch Tool - Single

- \* Hard shell case
- \* 1" x 50' SpeedTape
- \* 3/8", 9/16" and 18mm die
- \* Hole Punch Tool
- \* PowerHead Screws

You need one cap and not 100? The Custom Color Punch Kit™ is the tool for you. Take any standard edgeworking or veneer, apply SpeedTape, punch your cap out and you are done.

#### Features...

- \* Precision steel dies
- \* Ratcheting cutters
- \* Built in Ejector Pin

#### Great for...

- \* Making custom caps
- \* Covering screws
- \* Covering mistakes

Part Number	Description
88FCHOLEPUNCH	Hole Punch - Single
88FCHOLEPUNCHSET	Hole Punch Kit

Part Number	Description
88FCHPDIE18MM	18mm Die for Punch
88FCHPDIE3/8	3/8" Die for Punch
88FCHPDIE9/16	9/16" Die for Punch
88FCHPBUSHING	White Bushing for Punch



### Speed Dollie

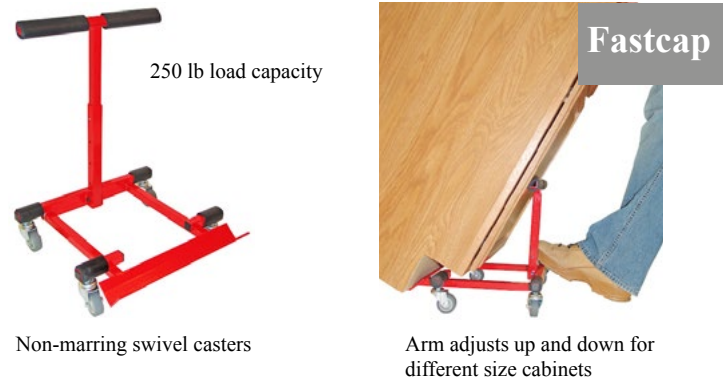

The Speed Dollie™ is compact and requires only one person to move awkward cabinets. Its rugged design and adjustable support arm allow you to handle tall pantry cabinets, appliances, file cabinets or regular base cabinets with ease.

Part Number	Description
88FCSPEEDDOLLIE	Speed Dollie

### Little Hand



The Little Hand HD™ is designed to support upper cabinets after the base cabinets have been installed. This innovative product removes all the hassle of supporting upper cabinets during installation.

#### Features...

- \* Precision jack system
- \* Telescoping 16.5" - 22.8"
- \* Oversized 6x6 support foot

#### Great for...

- \* Supporting upper cabinets
- \* Lifting
- \* Spreading

Part Number	Description
88FC3HLITTLE2PCSYS	Little Hand - 2 pack, bag 4 Universal Foot





## 3rd Hand HD

Fastcap

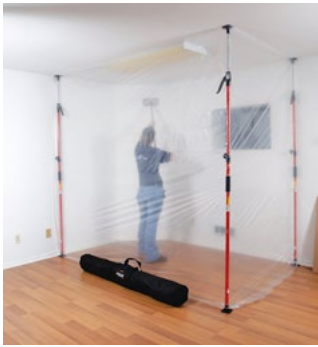

Precision pump jack

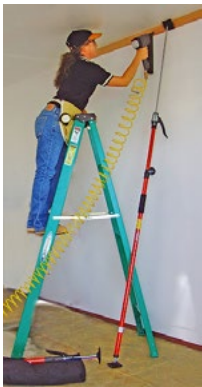

150 lb load capacity

5' - 12'



The 3rd Hand HD™ is the help you've been looking for. If you ever wished you had an extra hand, look no further. It is rugged, built to last a lifetime and it's never late to work! Brace, jack, or support whatever you need.

Features...

- \* Precision jack system
- \* Telescoping 5' - 12'
- \* Magnetic Dust Barrier foot

Great for...

- \* Hanging cabinets
- \* Dust barriers
- \* Laser mounting

Part Number	Description
88FC3HAND5HD	3rd Hand HD - Single
88FC3HBAG	Ballistic nylon carry bag - fits four 3rd Hands



## Flex Screw Bag



Screws and accessories not included



The Flex Screw Bag allows you to keep your screws separate and organized easily thanks to writable tabs. Built from tough ballistic nylon and fully collapsible.

Features...

- \* Heavy duty ballistic nylon
- \* Collapsible for easy storage
- \* Tabs for organization

Great for...

- \* Screws
- \* Nails
- \* Staples

Part Number	Description
88FCFLEXSCREWBAG	Flex Screw Bag

## Flex Tool Bag



Tools not included

Tired of tool bags that don't fit your tools? Wrong size pockets? Too small... too big? The FLEX Tool Bag™ solves all these problems with this new innovative and flexible design from FastCap.

Features...

- \* Heavy duty ballistic nylon
- \* Industrial hook and loop
- \* 100% arrangeable pockets

Great for...

- \* 14 - Pockets
- \* 1 - Shoulder strap/Tool belt
- \* 1 - Magnetic ProHold

Part Number	Description
88FCFLEXTOOLBAG	Flex Tool Bag with 14 pockets



## Pocket Chisels



Buy them individually or in a kit!



The Pocket Chisel™ is made of precision tool steel and has a heavy duty nylon handle that locks when opened and will stay locked so that you can hammer the hell out of it.

Part Number	Description
88FCPCKIT	Pocket Chisel Kit
88FCPCDIAMSHRPNR	Pocket Diamond Sharpener
88FCPCPTYKNIFE	Pocket Putty Knife
88FCPCCOMBOPTY	Pocket Combo Putty Knife
88FCPC1	Pocket Chisel 1" Blade
88FCPC3/4	Pocket Chisel 3/4" Blade
88FCPC1/2	Pocket Chisel 1/2" Blade
88FCPC1/4	Pocket Chisel 1/4" Blade
88FCPCCASE	Hard Shell Case (Green)



## ProCarpenter Tape Measures



Fastcap

The ProCarpenter Tape Measures™ are developed with 7 great innovative features: Lever action belt clip, Pencil sharpener, Dual locking system, Erasable notepad, Heavy-duty, 1" blade, High-contrast tape and Rugged compact design.



The Old Standby features Standard measurements that are readable from either the right or left hand.



The Story Pole features a blank edge on the blade for writing and standard measurements on the other edge.

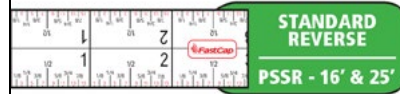

The Standard/Standard Reverse features standard measurements that are readable from the right or left hand.



The PMS features Metric and standard measurements identifying increments down to 1/16" and millimeter.



The Metric/Metric Reverse features metric measurements that are readable from the right or left hand.

Part Number	Description
88FCPS16	1" x 16' Old Standby Tape Measure
88FCPS25	1" x 25' Old Standby Tape Measure
88FCPS30	1" x 30' Old Standby Tape Measure
88FCPSSPFLAT16	1" x 16' Flat Back Story Pole Tape Measure
88FCPSSR16HD	1" x 16' Standard Reverse Tape Measure
88FCPSSR25	1" x 25' Standard Reverse Tape Measure
88FCPMS12	1" x 12' Metric/Standard Tape Measure
88FCPMS16HD	1" x 16' Metric/Standard Tape Measure
88FCPMS25	1" x 25' Metric/Standard Tape Measure
88FCPMMRTRUE32	1" x 16' True 32 Metric Reverse Tape Measure



## AutoLock Tape Measure

Fastcap

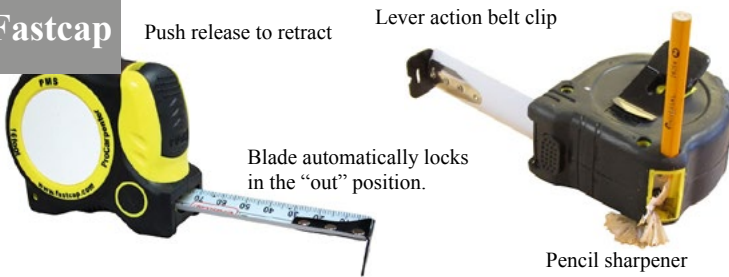

The ProCarpenter AutoLock™ tape measure has all the features of the original ProCarpenter, plus the autolock and super-ergonomic design. Simply pull the blade out and it stays in place then push the release button to retract the blade..

Part Number	Description
88FCPMS16AUTOLOCK	1" x 16' ProCarpenter AutoLock Tape Measure

## Peel & Stick Tape Measures



The flat 16' long tape measure is printed on both sides allowing for left or right read. Simply adhere the included SpeedTape to one side of the tape and stick it on.

Part Number	Description
88FCPSSTICK16	1" x 16' Standard Peel & Stick Tape Measure
88FCPMSSTICK16	1" x 16' Metric/Standard Peel & Stick Tape Measure

## SpeedClip



Built in Sharpener for a normal pencil

Extension keeps tape measure from getting bumped off when bending down

Holds a normal pencil or carpenter pencil

Never have torn pants again. Securing your tape measure is a breeze with the SpeedClip™. It easily clips over your pants or belt or screws to a workbench. It can even hold and sharpen a pencil.

Part Number	Description
88FCSPEEDCLIP	Speed Clip



## Flush Cut Series



The Micro Flush Cut Trimmers™ design allows you to get into tight spots when removing brad nails or small slivers. (Ok to pull nails, not recommended for cutting nails).



The Macro Flush Cut Trimmer™ works great with wood and PVC edgebanding with standard thicknesses of .018"-.025" (Not recommended for 3mm edgebanding, nails or screws).



The Heavy Duty (HD) Flush Cut Trimmers™ cut nails flush. Includes two high powered neodymium magnets to help catch metal debris. (Not recommended for hardened screws).



The End Nippers™ have a flush 1" wide head that can be used for cutting fret wires, up to 3mm edgebanding and a variety of other applications. (Not recommended for cutting nails. Great for metals like brass & copper).



The Stainless Steel Fret Nippers™ are a special new fret nipper designed by a Luthier for a beautiful flush trim on your frets everytime. (Not recommended for cutting nails. Great for metals like brass & copper).



The Power Shears™ are small and compact, yet razor sharp and cut through the toughest material like veneer, burlap or even aluminum

Part Number	Description
88FCPLIERSMICRO	Micro Flush Cut Trimmers
88FCPLIERSFC	Macro Flush Cut Trimmers
88FCPLIERSFCHD	Heavy Duty Flush Cut Trimmers
88FCPLIERSENDNIP	End Nip Trimmers
88FCPLIERSFRETNIP	Stainless Steel Fret Nippers
88FCPOWERSHEARS	Power Shears



## PowerMags



Small and powerful!

PowerMags™ will transform the way you use magnets. These versatile, high-performance neodymium magnets can be used to make invisible magnetic catches, as well as hold anything and everything metal. Get creative!



Holey PowerMags™ feature holes to accommodate a screw for attaching the magnet to your surface. The magnets are countersunk for 3/8" PowerHead Screws.

Part Number	Description
88FCPOWERMAG	9/16" PowerMags (10 pack)
88FCPOWERMAGH18	9/16" PowerMags with 1/8" Hole (10 pack)

## Super Mag



12 lb load capacity

The Super Mag™ is great for anything you want to hold something to a metal surface. It is powered by 6 high performance neodymium magnets encased in soft non marring EVA. An extra long knob allows for quick placement and removal.

Part Number	Description
88FCSUPERMAG	Super Mag



## Magnetic Micro Square



Outside scale for blade height.

Fastcap

Inside scale for layout

The Magnetic Micro Square™ makes squaring up your saws or other pieces of equipment effortless! The square sticks firmly to the cast iron table and allows hands free adjustment of spindles, blades and fences.

Features...

- \* Imperial scale and Metric scale
- \* Store it on your saw with built in magnets
- \* 2 neodymium magnets embedded in the base

Part Number	Description
88FCMAGMICROSQ	Mag Micro Square

## AccuScribe Pro



The AccuScribePro™ makes it easy to maintain a consistent scribe offset, staying parallel to the object surface everytime. It is ideal for flooring, counter tops, scribing trim on cabinets and more.

Features...

- \* Flat bottom for precise marking
- \* Retractable compass point
- \* Built-in pencil sharpener

Great for...

- \* Making a radius
- \* Marking gauge
- \* Scribing

Part Number	Description
88FCACCUSCRIBE	AccuScribe Pro



## FastBreak

Fastcap



Our FastBreak™ sanders uniformly break both edges on sharp melamine, edgebanding and hardwood material in just one pass. For larger panel stock the FastBreakXL™ will sand up to 2-3/8".

### Features...

- \* Break both edges in one pass
- \* Comes with 80 & 180 grit
- \* Convenient sandpaper storage

### Great for...

- \* Melamine
- \* Edgebanding
- \* Door (FastBreakXL)

Part Number	Description
88FCFASTBREAK	FastBreak
88FCFASTBREAKXL	FastBreak XL for larger panel stock
88FCFB180GRIT10PC	Sandpaper 180 Grit - 10 pc
88FCFB80GRIT10PC	Sandpaper 80 Grit - 10 pc

## TriBlade

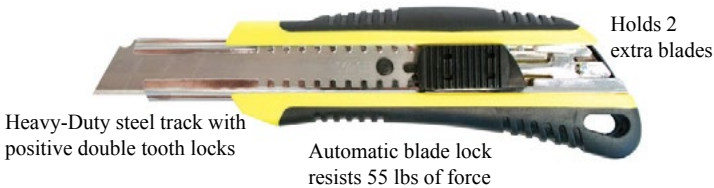

Heavy-Duty steel track with positive double tooth locks

Automatic blade lock resists 55 lbs of force

Holds 2 extra blades

The TriBlade Utility Knife™ has a unique design that allows for additional storage of 2 extra blades. The rubberized grip makes it comfortable to hold and the retractable self-locking blade makes the TriBlade safe to use. Includes 3 heavy duty snap off blades.

Part Number	Description
88FCTRIBLADE	TriBlade Knife
88FCTRIBLRPLC	Replacement Blade 10 pk



## The FatBoy Pencil



Never break your lead again with The FatBoy™ Pencil. It combines the utility of a mechanical pencil with the strength of a carpenter pencil. Easily sharpens in a standard pencil sharpener and this unbreakable 5.5mm lead stays sharp longer. Includes 3 lead.

### Features...

- \* Lightweight aluminum housing
- \* Removable clip
- \* Built-in eraser

### Great for...

- \* Framing
- \* Finish work
- \* General use

Part Number	Description
88FCFBP	The FatBoy Pencil
88FCFBPREFILL	FatBoy Replacement Lead & Erasers

## FastWrap



Secure loose wires and cables quickly using FastWrap. Made with durable, indestructible VELCRO® brand.

Part Number	Description
88FCFW12X150	FastWrap 1/2" x 150' Roll





## Taper Lock & Tip Mag



Taper Lock



Tip Mag

### TaperLock Features...

- \* One-hand operation
- \* Grips any length of bit
- \* Fast and easy bit changes

### TipMag Features...

- \* Powerful Neodymium magnets
- \* Fits on nearly any driver
- \* Holds the screws on

The TaperLock™ and Tip Mag™ are two of the FastCap staff's favorite products! The TaperLock grips any bit while the Tip Mag holds onto the screws. What more could you ask for...Buy them together or separately.

Part Number	Description
88FCTAPERLOCK	Taper Lock
88FCTIPMAG	Tip Mag

## PowerHead Screws



The PowerHead Screw™ has an oversized flat head to completely eliminate pull-through. The oversized head has 4x the holding power than a conventional screw head and can be finished with a 9/16" or 18mm Fastcap.

### Features...

- \* Flat oversized 9/16" head
- \* Self-tapping for wood & metal
- \* Zinc coated for corrosion resistance

### Great for...

- \* Cabinets
- \* "Invisible" fasteners for Fastcaps
- \* Fastening to metal studs

Part Number	Description	Box Quantity
88FCPHZ8ME22000PC	8 x 2 Square Powerhead	2,000
88FCPHZ825150SQ	8 x 2 1/2 Square Powerhead	150
88FCPHZ8251500SQ	8 x 2 1/2 Square Powerhead	1,500
88FCPHZ8350SQ	8 x 3 Square Powerhead	50
88FCPHZ831500SQ	8 x 3 Square Powerhead	1,500



## Kolbe Korner



Fastcap

Secure mounting of the drawer front

Bracing for drawer bottoms

The Kolbe Korner™ is a mounting bracket for shaker style drawer fronts. It allows for the drawer face to be mounted to the box easily, quickly and without hassle. Available in metal and nylon.

### Nylon

Part Number	Color	Description
88FCKK50PCBL	Black	50 Pack
88FCKK50PCCM	Clear Maple	50 Pack
88FCKK50PCLM	Light Maple	50 Pack
88FCKK50PCWH	White	50 Pack
88FCKK500PCLM	Light Maple	500 Bulk Pack
88FCKK500PCWH	White	500 Bulk Pack

### Metal

Part Number	Color	Description
88FCKK50PCALUM	Aluminum	50 Pack
88FCKK50PCMTLTN	Tan	50 Pack
88FCKK50PCMTLWH	White	50 Pack
88FCKK500PCMETALTN	Tan	500 Bulk Pack
88FCKK500PCMETALWH	White	500 Bulk Pack

## Drawer Bumper



The Drawer Bumper protects doors from unintentional marring by drawer pull-outs.

Part Number	Description
88FCDRAWERBUMP	Drawer Bumper 10 pc



## ETR Electric Trim Ring

Fastcap



The ETR - Electrical Trim Ring™, is designed to clean up electrical cutouts in the back of cabinets. It comes in two versatile sizes for single and double gang boxes and can be trimmed to specific return depths.

### Features...

- \* Works well with Outlet Stamp
- \* Custom colors also available
- \* 1-1/4" depth & trim lines every 1/4"

Part Number	Color	Description
88FCETRSINGLEHMPL	Hardrock Maple	Electrical Trim Ring Single
88FCETRSINGLE	White	Electrical Trim Ring Single
88FCETRSINGLE10PCWH	White	Electrical Trim Ring Single (10pk)
88FCETRDOUBLEHMPL	Hardrock Maple	Electrical Trim Ring Double
88FCETRDOUBLE	White	Electrical Trim Ring Double

## FlipBolt



The FlipBolt is the ultimate tool-less countertop connector. Simply finger tighten it and flip the arm down to lock in place. Works with most countertops.

Part Number	Description
88FCFLIPBOLT	FlipBolt (4 1/2")
88FCJHOOK	J-Hook (2 pack)
88FCFLIPBOLTJIG	Template



## QwikDraw



Use the QwikDraw to join countertops without any special boring or machining. Fast, strong and accurate.

Part Number	Description
88FCQWIKDRAW	QwikDraw connector

## SpeedBrace



The heart of the SpeedBrace™ is the 1-1/2" x 1-1/2" notching system that makes for fast and easy alignment after installing a level cleat along the wall. 1,000 lbs. load capacity per pair (on 16" centers).

### Features...

- \* Alignment notch for fast installation
- \* Holes for routing wires and cables
- \* No Kicker

### Great for...

- \* Fixed height shelving
- \* Countertops/desks
- \* Customized workstations

Part Number	Color	Description
88FCSB8BL	Black	8" x 12" Speed Brace
88FCSB8SS	Stainless Steel	8" x 12" Speed Brace
88FCSB8WH	White	8" x 12" Speed Brace
88FCSB15BL	Black	15" x 18" Speed Brace
88FCSB15SS	Stainless Steel	15" x 18" Speed Brace
88FCSB15WH	White	15" x 18" Speed Brace
88FCSB21X24BL	Black	21" x 24" Speed Brace
88FCSB21BL	Black	21" x 28" Speed Brace
88FCSB21SS	Stainless Steel	21" x 28" Speed Brace
88FCSB21WH	White	21" x 28" Speed Brace





## SpeedBrace Stealth



300 lb load capacity



The Stealth Speedbrace™ supports your countertop and bar overhangs with no visible kicker or expensive corbels. Each brace will support 300 pounds of weight, so go ahead test that kitchen counter!

### Features...

- \* 1/4" Steel
- \* Powder-coated
- \* Countersunk screw holes

### Great for...

- \* Countertops
- \* Bars
- \* Extra Bracing

Part Number	Description
88FCSTEALTH12BL	3.5" x 12" Black Stealth Speedbrace
88FCSTEALTH16BL	3.5" x 16" Black Stealth Speedbrace
88FCSTEALTH24BL	3.5" x 24" Black Stealth Speedbrace

## RocLoc

When you can't find a stud, use a RocLoc!



1/2" load capacity (up to) 150 lbs    5/8" load capacity (up to) 200 lbs



\* Results may vary due to age, condition & quality of drywall

When you can't find a stud, use a RocLoc! Designed to work with 1/2" or 5/8" drywall, the RocLoc resists shear and does not allow the load to slide. Easy to install and NO fumbling with toggles or multiple steps.

### Features...

- \* Resists shear
- \* Easy to install
- \* Removable and reusable

### Great for...

- \* Bathroom fixtures
- \* Shelving
- \* Mirrors

Part Number	Description
88FCROCLOC10PK	RocLoc 1/2" 10 Pack with 1-1/4" PowerHead Screws
88FCROCLOC5/810PC	RocLoc 5/8" 10 Pack with 1-1/4" PowerHead Screw



## Smart Cleat

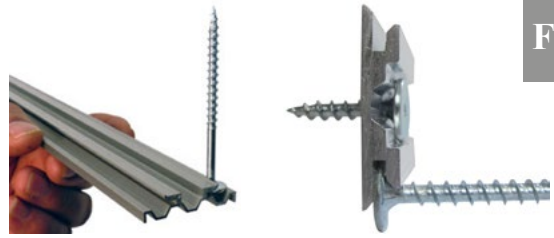

Fastcap

The Smart Cleat eliminates the frustration of hanging panels using the traditional French cleat system. It allows you unlimited adjustment without shims and allows you to hang the panel only 3/16" from the ceiling to eliminate excess trim.

### Features...

- \* No shims
- \* No extra trim or finish work
- \* Only 3/16" lift-off

### Great for...

- \* Panels
- \* False walls
- \* Large frames

Part Number	Description
88FCSMARTCLEAT	4' Smart Cleat

## SoftWax



SoftWax™ is a great way to fill holes in finished woodwork! The refillable kit comes with 20 blendable colors, a WaxWedge and a buffing pad. The hard shell case keep the wax where you want it, when you want it.

### Features...

- \* 20 blendable colors
- \* Refillable hard shell case
- \* Simple application

### Great for...

- \* Filling holes in finished wood
- \* Repair small holes & scratches
- \* Color matching

Part Number	Description
88FCWAXKIT	SoftWax Kit
88FCWAX01S thru 88FCWAX20S	SoftWax Refill Sticks
88FCWAX11SR	SoftWax Refill Red
88FCWAX13SY	SoftWax Refill Yellow
88FCWAX12SG	SoftWax Refill Green
88FCWAXWEDGE	WaxWedge Refill
88FCWAXBUFFPAD	Buffing Pad Refill





## 2P-10 Adhesive

Fastcap



Solo Kit

2P-10™ is a two-part ten-second adhesive. Just apply the adhesive, then spray the activator and stick it together for a strong, permanent bond. Its greatest benefits are its speed and strength

### Features...

- \* Easy to sand within 60 sec.
- \* Dries crystal clear
- \* 4000 PSI tensile & shear

### Includes...

- \* Non-clogging pin-cap
- \* 2 year shelf-life guaranteed



2P-10 Kit

### Great Starter Kits

Part Number	Description
88FC2P10KIT	2P-10 2.25oz Kit
88FC2P10SOLO	2P-10 Solo Kit
88FC2P10SOLOACT	2P-10 12oz Aerosol Activator



- Excellent for filling micro cracks
- Zero glue line



- For use on smooth surfaces such as laminate
- Excellent for filling medium cracks



- For use on porous surfaces such as particle board

### Most Popular



- Will not run, great for vertical surfaces
- All purpose application

### Refills

Part Number	Description
88FC2P10THIN10	2P-10 10oz Thin
88FC2P10MED10	2P-10 10oz Medium
88FC2P10THK10	2P-10 10oz Thick
88FC2P10JEL	2P-10 10oz Jel
88FC2P10SOLOACT	2P-10 12oz Activator



## GlüBot & BabeBot



16 oz GlüBot

4 oz Babe-bot



Easy fill wide mouth

Wide bottom for extra stability

The GlüBot™ is designed with a 2-chamber system that pushes glue fro the bottom up through the secondary side chamber which ensures fresh glue every time.

### Features...

- \* Replaceable tips & cap storage
- \* Dispenses glue from the bottom first
- \* 1 Blade tip, 1 Yorker tip & 1 Red cap

### Great for...

- \* Yellow glue
- \* Wood glue
- \* Other liquids

Part Number	Description
88FCGLUBOT	Glü-Bot 16oz
88FCBABEBOT	Babe-Bot 4oz

## Skins HD Gloves

### High-Performance Textured Latex Gloves



### Features...

- \* Snag, puncture & abrasion resistant
- \* Superior grip in dusty & oily applications
- \* Machine washable & dries quickly

### Great for...

- \* General construction
- \* Lumber and millwork
- \* Metal work

Part Number	Description
88FCSKINSHDS	Small gloves (Blue)
88FCSKINSHDM	Medium gloves (Yellow)
88FCSKINSHDL	Large gloves (Green)
88FCSKINSHDXL	XLarge gloves (Red)



## CatEye Safety Mags

ANSI Rated  
Z87.1



### Features...

- \* Ultralight Featherweight design
- \* +3.0, +2.5, +2.0, +1.5
- \* Shatterproof wrap-around lenses

### Great for...

- \* General purpose jobs
- \* Seeing what you are looking at
- \* Comfort while you work

Part Number	Description
88FCSGMAG15	Safety Glasses 1.5 diopter
88FCSGMAG20	Safety Glasses 2.0 diopter
88FCSGMAG25	Safety Glasses 2.5 diopter
88FCSGMAG30	Safety Glasses 3.0 diopter
88FCTAFMAG15	Tinted Safety Glasses 1.5 diopter
88FCTAFMAG20	Tinted Safety Glasses 2.0 diopter

## CatEye Safety Glasses

ANSI Rated  
Z87.1



### Features

- \* Ultralight Featherweight design
- \* ANSI / OSHA approved
- \* Shatterproof wrap-around lenses

### Great for...

- \* General purpose jobs
- \* Clear visibility
- \* Looking great while you work

Part Number	Color	Description
88FCSGP510	Clear	Clear Safety Glasses
88FCSGP510T	Tinted	Tinted Safety Glasses
88FCSGA510	Amber	Amber Safety Glasses
88FCSGM510	Mirrored	Mirrored Safety Glasses
88FCSGAFB510	Blue	Blue Safety Glasses
88FCSGGOGGLES	Clear	Clear Safety Goggles



## HOD - Handle On Demand

Fastcap



2,000 lb  
Load Capacity

1,000 lb  
Load Capacity

HOD's do not work  
on raw wood, uneven,  
porous or dirty surfaces

Stop straining your back trying to lift heavy stuff...suck it up!  
With our HOD (Handle on Demand) single or double, just  
fasten the suction pads to any non-porous surface and move it,  
lift it, place it, transport it with ease.

### Features...

- \* Heavy duty design
- \* Amazing suction holding power
- \* Lever locks for security

### Great for...

- \* Cabinets
- \* Glass
- \* Countertops

Part Number	Description
88FCHODSINGLE	Handle On Demand Single
88FCHODDOUBLE	Handle On Demand Double

## Staple Setter

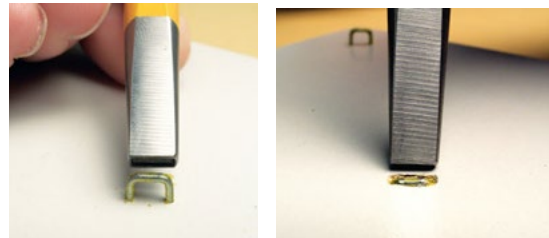

Part Number	Description
88FCSTAPLESETTER	Staple Setter Punch

## 3M™ Dust Masks and Respirators



Dust Masks/  
Ear Plugs

Part Number	Type	Pieces Per Box	Boxes Per Case
3M05113137082	3M™ Medium Half Facepiece Respirator 7502	1	10
3M05113137083	3M™ Large Half Facepiece Respirator 7503	1	10
3M05113821674	3M™ Organic Vapor Cartridge 6001	2	60
3M05113817668	3M™ Filter Retainer 501	20	5
3M05113117172	3M™ Particulate Filter 2297	2	50
3M05113846464	3M™ Particulate Filter 5N11, N95	10	10
3M05113846457	3M™ Respirator 8210, N95	20	8
3M05113854343	3M™ Respirator 8511, N95	10	8
3M05113191913	3M™ Respirator 8200S, N95	20	8

## 3M™ Earplugs



3M™ E-A-Rsoft™ Yellow Neons™  
Uncorded Earplugs in Poly Bag, Regular Size  
312-1250  
Packed 200 pairs per Box  
10 boxes per case  
Part Number: 3M08052912063

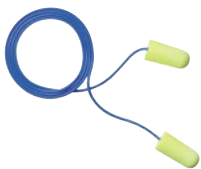

3M™ E-A-Rsoft™ Yellow  
Neons™ Corded Earplugs in Poly  
Bag, Regular Size 311-1250  
Packed 200 pairs per Box  
10 boxes per case  
Part Number: 3M08052911033



3M™ E-A-R™ UltraFit™  
Corded Earplugs in Poly Bag 340-4004  
Packed 100 pairs per Box  
4 boxes per case  
Part Number: 3M08052940003

**IMPORTANT:** The 3M products shown in this catalog must be used in accordance with OSHA regulations, and the user instructions, warnings, and limitations accompanying each product.

## 3M™ Protective Eyewear



3M™ Virtua™ with Foam Gasket,  
Clear, Anti-Fog Lens  
Packed 20 per Box  
Part Number: 3M07837111872



3M™ BX™ Silver/Black Frame,  
Clear, Anti-Fog Lens  
Packed 20 per Box  
Part Number: 3M07837162052

## Torrent Safety Glasses - Global Gloves



Torrent Clear Safety Glasses  
Packed 12 per Box  
Part Number: GGBH111



Torrent Tinted Safety Glasses  
Packed 12 per Box  
Part Number: GGBH133

## Nitrile Disposable Gloves

Manufactured using a soft and stretchy formulation that offers excellent durability as well as comfort. Textured for enhanced gripping power.



9 1/2" Length, 4.0 mil (palm)  
Industrial grade



Part Number	Description	Size	Box Quantity
83HFN201	Blue No Powder	Small	100
83HFN202	Blue No Powder	Medium	100
83HFN203	Blue No Powder	Large	100
83HFN204	Blue No Powder	X-Large	100

**IMPORTANT:** The 3M products shown in this catalog must be used in accordance with OSHA regulations, and the user instructions, warnings, and limitations accompanying each product.

## Latex Disposable Gloves



Natural color Latex disposable powder free gloves. Textured finish for good wet grip, ambidextrous, industrial grade, 9" length with a rolled/beaded cuff. Component materials comply with FDA regulations for food contact.  
Sold per box.

Part Number	Description	Size	Box Quantity
GG305PFMD	Latex No Powder	Medium	100
GG305PFLG	Latex No Powder	Large	100

## Nitrile Disposable Gloves



5 mil black Nitrile disposable powder free gloves. Textured finish for good wet grip, ambidextrous, industrial grade, 9" length with a rolled/beaded cuff. Component materials comply with FDA regulations for food contact.  
Sold per box.

Part Number	Description	Size	Box Quantity
GG705BPFMD	Black Nitrile No Powder	Medium	50
GG705BPFLG	Black Nitrile No Powder	Large	50
GG705BPFXL	Black Nitrile No Powder	X-Large	50

## Panther-Guard® Gloves



Disposable 8 mil Black Flocklined 100% Nitrile. Flocklined interior helps keep hands warm when it gets cool and absorb perspiration when it gets hot. 100% inspected, triple washed and neatly packed flat in the box. 11" length, fully textured and rolled/beaded cuff. Component material comply with FDA regulations for food contact.  
Sold per box.

Part Number	Description	Size	Box Quantity
GG800FLG	Black Panther-Guard®	Large	50

## 500NFT Nitrile Gloves



Tsunami Grip® - new foam technology nitrile on 15 gauge gray nylon shell. Outstanding wet oil grip. Fantastic dexterity, fit and feel.  
Sold per box.

Misc  
Supplies

Part Number	Description	Size	Box Quantity
GG500NFTM	Tsunami Grip® Nitrile	Medium	12 pairs
GG500NFTL	Tsunami Grip® Nitrile	Large	12 pairs
GG500NFTXL	Tsunami Grip® Nitrile	X-Large	12 pairs

## Pug-13 Nylon Gloves



Gray polyurethane coated on gray 13 gauge nylon.  
Sold per box.

Part Number	Description	Size	Box Quantity
GGPUG13SM	13 Gauge Nylon	Small	12 pairs
GGPUG13MD	13 Gauge Nylon	Medium	12 pairs
GGPUG13LG	13 Gauge Nylon	Large	12 pairs
GGPUG13XL	13 Gauge Nylon	X-Large	12 pairs

## FrogWear™ Gloves



Blue seamless triple dipped PVC is specially formulated for handling of chemical residues, oils or greasy materials. The specially formulated PVC stays flexible in temperatures down to -5°. The sand paper grip enhances handling of slippery objects wet or dry. PVC sleeve for added protection.

Part Number	Description	Size	Box Quantity
GG8690LG	FrogWear™ Glove	Large	12 pairs

### 3M™ Citrus Cleaner



Multi-purpose cleaner which will dissolve and flush away dirt, grease, tar, most non-curing type adhesive films, and similar substances. Can be used to clean and degrease metal part, motors, tools, printing presses, and concrete. 24 fl oz Can, 12 Cans per Case

Part Number: 3M02120076394

Misc  
Supplies

### 3M™ Citrus Base Adhesive Remover



Dissolve away the overspray of many adhesives used in countertop lamination. Cleans away grease, oil, and grime from floors in garages, machining rooms, and other industrial sites. Cleans away tape residue, tar, wax, and more. Removes marker graffiti and the residue of tape, stickers, and labels on locker surfaces.

24 fl oz Can, 6 Cans per Case

Part Number: 3M02120049048

### 3M™ Silicone Lubricant



Fast drying long lasting spray lubricant. Contains no petroleum oils, non staining, and up to 350°F (177°C) resistance. Helps prevent build-up of glues wax, inks and paints. Rubber mold release. Helps preserve plastic, rubber and leather. Use to lubricate tools, tables, sewing machines and needles. Clear color and particle mist spray pattern.

24 fl oz Can, 12 Cans per Case

Part Number: 3M02120085822

### Lube



Size	Part Number	Type
10.75 oz	79BKDC	Dri-Cote (BladeCote)
10.75 oz	79BKTC	Top-Cote (GlideCote)

### Cotton Wiping Rags



Part Number	Packed	Type	Color
83S70220	20 lb box	Cotton Knit	White
83S70350	50 lb bale	Cotton Knit	White
83S50350	50 lb bale	Cotton Knit	Color
83S54350	50 lb bale	Cotton Knit	Grey
83S22340	40 lb bale	Terry	Turkish
83S70B350	50 lb bale	Reclaimed Knit	White

### Wood Shims



Part Number	Size	Wood Type	Box Quantity
7152CS09	9"	Cedar	480

### Poly Bags

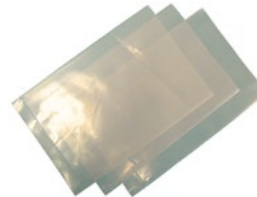

Part Number	Size	Mil	Box Quantity
71020305	3" x 5"	4 Mil	2,000
71020406	4" x 6"	4 Mil	2,000
71020507	5" x 7"	4 Mil	1,000
71020510	5" x 10"	4 Mil	1,000
71020520	5" x 20"	4 Mil	1,000
710206106	6" x 10"	6 Mil	1,000
71020812	8" x 12"	4 Mil	1,000



## Wood Glue - Franklin



Size	Color	Type	Part Number
5 Gallon	Natural	Multibond 1040	7901FMB104005
5 Gallon	Natural	Multibond SK8	7901FSK85
5 Gallon	White	Woodbond 75	7901FTB7505
5 Gallon	Yellow	Woodbond 75	7901FTB7505Y
55 Gallon	Brown	Woodbond 75	7901FTB7555B
55 Gallon	White	Woodbond 75	7901FTB7555
55 Gallon	Yellow	Woodbond 75	7901FTB7555Y
55 Gallon	Brown	Titebond 433	7901F43355B

## Booth Coating - Franklin



Size	Color	Type	Part Number
5 Gallon	Natural	Bates Boothcoating	7901FBBC

## 3M™ Fastbond™ Contact Adhesive 30NF



Water-based, spray, roll or brush apply.  
Post-formable and heat resistance.

Size	Part Number	Type	Color
1 Gallon	3M02120021181	NF 30	Natural
5 Gallon	3M02120021182	NF 30	Natural



## Titebond® Original Glue

Titebond Original Wood Glue is the industry standard for wood-working. It provides a strong initial tack and fast speed of set to reduce clamp time. It also develops a bond stronger than the wood itself, offers excellent sandability and is unaffected by finishes. It is ideal for wood, hardboard, particleboard, leather, cloth and most other porous materials. Titebond Original is easy to use, non-toxic and cleans up with water.



Size	Part Number
1 Gallon	7901TB5066
Pro Jug 2.15 Gallon	7901TB50609

Adhesives

## Titebond® II Premium Glue

Titebond II Premium Wood Glue is the only leading brand, one-part wood glue that passes the ANSI Type II water-resistance specification. It is ideal for exterior woodworking projects. Provides a strong initial tack, fast speed of set, superior strength and excellent sandability. It is FDA approved for indirect food contact (cutting boards) and is ideal for radio frequency (R-F) gluing systems.



Size	Part Number
1 Gallon	7901TB5006
Pro Jug 2.15 Gallon	7901TB50009
5 Gallon	7901TB5007

## Titebond® III Ultimate Glue

Titebond III Ultimate Wood Glue is the first one-part, water cleanup wood glue ever offered that is proven waterproof. The waterproof formula passes the ANSI/HPVA Type I water-resistance specification and offers superior bond strength, longer open assembly time and lower application temperature. Non-toxic, solvent free and cleans up with water - safer to use than traditional waterproof wood glues. It provides strong initial tack, sands easily without softening and is FDA approved for indirect food contact (cutting boards). Ideal for both interior and exterior applications.



Size	Part Number
1 Gallon	7901TB1416
Pro Jug 2.15 Gallon	7901TB14109
5 Gallon	7901TB1417

## Melamine Glue



Size	Part Number	Brand	Color
Pint	7901R2032	Roo	Clear
1 Gallon	7904R1GL	Roo	Clear
1 Gallon	7901TB4016	Titebond	White
5 Gallon	7901TB4017	Titebond	White

Adhesives

## Edgebanding Glue



Pellets Packed 44 lbs per Box  
Cartridges Packed 48 per Box

Part Number	Jowat Number	Resin Base	Type	Color	Pounds per Box
7916EPI33	288.70	EVA	Pellets	Natural	44 lbs
7916J28220	282.20	EVA	Pellets	Natural	44 lbs
7916EPI33BL	288.73	EVA	Pellets	Black	44 lbs
7916EPI33C	280.90	EVA	Pellets	Clear	44 lbs
7916J28030	280.30	EVA	Pellets	Natural	44 lbs
7916J28860	288.60	EVA	Pellets	Natural	44 lbs
7916EPI58	286.80	EVA	Cartridges	Natural	48 lbs
7916EPI58BL	286.83	EVA	Cartridges	Black	48 lbs
7916EPI58C	286.30	EVA	Cartridges	Clear	48 lbs
7916EPI58WH	286.81	EVA	Cartridges	White	48 lbs



## Titebond® Original Glue



Titebond Pump for ProJugs/Gallons

Part Number: 7901TB60015

## Glue Bottles



Item	Part Number
Pint - Short	790016HD
Pint - Tall	790016HDT
Quart	790032HD
Pour Spout	790008YS
Drum Spout	790055S

## Glue Capsules for 8mm Dowels



8mm Glue Capsules for 8mm Dowels  
Capsules are pre-filled with fast set PVAc glue.  
Just drop in the plastic capsule, tap in the dowel  
and let the glue do the work.  
Sold 20,000 per Bucket



Part Number: 7906TDC0003

Dowels are available.  
see page 111.

## 3M™ Scotch-Weld™ Polyurethane Reactive Adhesive System

### 3M™ Scotch-Weld™ EPX™ Plus II Applicator 50mL



EPX Plus II Applicator is used to dispense 3M™ Scotch-Weld™ adhesives in duo-pak cartridges. Applicator, plunger and nozzle assembly give you the control you need for precise application. Easy to use applicator makes adhesives easy to dispense. Designed for 1:1 or 2:1 mix ratio.

Part Number: 3M02120050004

# 3M™ Scotch-Weld™ Polyurethane Reactive Adhesive System

## 3M™ Scotch-Weld™ Epoxy Adhesive



DP-100 adhesive is a flexible, two-part epoxy.  
 1:1 mix ratio  
 3-5 minute work life.  
 Slightly flexible when cured.  
 Packed 12 per case  
 Part Number: 3M02120087195



DP-105 is a clear, colorless, fast setting, flexible, two part epoxy.  
 1:1 mix ratio  
 3-5 minute work life.  
 Packed 12 per case.  
 Part Number: 3M02120087203

## 3M™ Scotch-Weld™ EPX™ Mixing Nozzle



Square Green Mixing Nozzle  
 Packed 12 per bag  
 Part Number: 3M07630886434



EPX 9742 Mixing Nozzle  
 Packed 12 per bag  
 Part Number:  
 3M02120021791

Adhesives

## 3M™ Scotch-Weld™ Hot Melt Adhesives

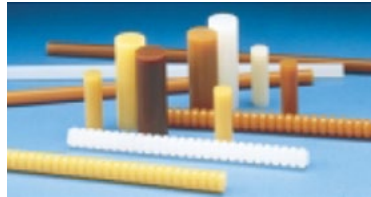

Part Number	Type	Features	Viscosity CPS	Size	Color	Pounds Per Case
3M05111191712	3750-AE	Low viscosity for high flow rate and increased production. Packaging and wood assembly. Good hot tack for quick grab.	1,900 @ 375° F	1/2" x 12"	Tan	25 lbs
3M02120049128	3762LM-PG	Low melt, 100% solids thermoplastic adhesive. Improved "hot tack" when dispensed at low melt temperature. Can bond breadboard, corrugated, and displays.	4,000 @ 250° F	1" x 3"	Light Amber	22 lbs
3M02120082411	3762LM-Q	Excellent "hot track" fast-setting. Bonds variety of corrugated packaging, beadboard, recoupage, repacking area. Economical general purpose. Can bond chipboard and wood.	4,000 @ 250° F	5/8" x 8"	Light Amber	11 lbs
3M02120065261	3762-Q	Excellent "hot track" fast-setting. Economical, general purpose for corrugated packaging, beadboard, recoupage, repacking area. Can bond chipboard and wood.	1,870 @ 375° F	5/8" x 8"	Tan	11 lbs
3M02120065263	3792-Q	Bonds-variety of plastics including polycarbonate, polyethylene and polypropylene. Flexible at low temperatures.	6,000 @ 375° F	5/8" x 8"	Clear	11 lbs

## 3M™ Scotch-Weld™ Hot Melt Applicator AE II



All electric operation.  
 Includes stand.  
 Weight: 20 oz  
 Output: 4 lb/hr  
 Temperature: 400° F  
 Adhesive Type: AE  
 Adhesive Size: 1/2" x 12"  
 Part Number: 3M02120096594



### 3M™ Scotch-Weld™ Hot Melt Applicator Low Melt with Quadrack Converter and Palm Trigger



Easy to use with standard melt adhesives. Includes Quadrack Converter and Palm Trigger.  
 Weight: 13.8 oz  
 Output: 2.6 lb/hr  
 Temperature: 265° F  
 Adhesive Type: Low Melt - Q  
 Adhesive Size: 5/8" x 8"  
 Part Number: 3M02120089447

### 3M™ Scotch-Weld™ Hot Melt Applicator TC with Quadrack Converter and Palm Trigger



Easy to use with standard melt adhesives. Includes Quadrack Converter and Palm Trigger.  
 Weight: 13.8 oz  
 Output: 3.5 lb/hr  
 Temperature: 385° F  
 Adhesive Type: Q  
 Adhesive Size: 5/8" x 8"  
 Part Number: 3M02120089445

## Adhesives

### 3M™ Scotch Weld™ Polyurethane Reactive (PUR) Easy 250 Adhesive

#### 3M™ Scotch-Weld™ Polyurethane Reactive (PUR) Easy 250 Adhesive Applicator - Yellow



Impact resistant plastic construction. Applicator rest holds applicator upright when not in use. Disposable nozzles for maintenance ease.

Part Number: 3M05111523563

#### 3M™ Scotch-Weld™ Polyurethane Reactive (PUR) Easy 250 Adhesive Preheater



Preheats Scotch Weld™ Polyurethane Reactive Easy 250 adhesive cartridges.

Part Number: 3M05111523564

#### 3M™ Scotch-Weld™ Polyurethane Reactive (PUR) Easy 250 Adhesive Cartridges



Part Number	3M Number	Description	Viscosity at 250°F	Shore D	Open Time	Set Time	Tensile Strength	Box Quantity
3M05111523541	250030	Fast set time for many plastics including polystyrene and polyacrylic.	13,000	50	2 min.	30 sec.	3,900 psi	5
3M05111523545	250015	Fast set time for wood and select plastics.	7,000	65	1.5 min.	15 sec.	3,900 psi	5
3M05111523550	250060	Medium set time for wood and select plastics.	7,000	60	2 min.	60 sec.	4,200 psi	5
3M05111523554	250120	Medium set time. Low viscosity. Very thin bond line for wood.	3,000	60	4 min.	120 sec.	4,000 psi	5
3M05111523559	250150	Long open and set times for wood, plastics, and material combinations such as aluminum or glass to plastics or wood.	9,000	150	4 min.	150 sec.	3,300 psi	5



## Spray Adhesive

### 3M™ Woodworking Spray Adhesive 20



High strength, fast-grabbing adhesive forms powerful, permanent bonds in woodworking and other applications. Bonds laminates, metals, plastics and more. Variable width lace spray pattern ensures precise placement. Color: Clear  
20 oz Cans, packed 12 cans per box.

Part Number: 3M05111107861

### 3M™ Foam & Fabric Spray Adhesive 24



Fast-tack adhesive bonds foam to metal, wood and many other substrates. Ideal for upholstery applications. Aggressive tack, foam-tearing strength and variable width lace spray pattern ensures precise placement. Color: Orange  
20 oz Cans, packed 12 cans per box.

Part Number: 3M05111107862

### 3M™ Multi Purpose Spray Adhesive 27



Extremely versatile adhesive is ideal for bonding paper, cardboard, fabrics, soft foams and many other lightweight materials. Fast tack, lightweight applications and mist spray pattern. Color: Clear  
20 oz Cans, packed 12 cans per box.

Part Number: 3M05111107832

## Caulking

### Acrylic Painters Caulk



Can be painted or stained with one coat and will not bleed through paint. Easy soap and water clean up.

Color	Part Number	Box Quantity
White - Only	7920T7301	12

## Caulking

### 100% Silicone



Solvent clean up.  
Not Paintable.

Color	Part Number	Box Quantity
Clear	792082601	12
White	792081601	12
Aluminum Gray	792081651	12



Adhesives

### 35 Year Acrylic Caulk With Silicone



Designed for both interior and exterior applications. Can be painted or stained with one coat and will not bleed through paint. Easy soap and water clean up.



Color	Part Number	Box Quantity
White	7920T8301	12
Clear	7920T8331	12

### Ultra 230 Premium Acrylic Sealant



Designed for both interior and exterior applications. Can be painted or stained with one coat and will not bleed through paint. Easy soap and water clean up.



Color	Part Number	Box Quantity
Almond	792077020	12
Brown	792077040	12
Black	792077060	12
Gray	792077050	12
Cedar	792077010	12

### Half-Barrel Caulk Gun



1/10 gallon, half-barrel with smooth rod and quick release mechanism. Holds most standard cartridges. Use for light to medium applications.

Part Number: 7920R3985

## Caulking

### Titebond® Construction Adhesive



A versatile formula designed for general purpose applications of most building materials. It is safe for use on wood, drywall, ceramic, metal, plywood, hardwood, and more. It exceeds the performance requirements of the AFG-01 and ASTM C557 specifications  
Indoor/outdoor use.

10.2oz  
12 tubes per box.

Part Number: 7921T3451

Adhesives/  
Wood Filler



### Titebond® Duramaster Sealant



Titebond® DuraMaster™ Sealant is the FIRST elastomeric, water-based sealant with 100% joint movement\*. This revolutionary sealant offers fantastic adhesion to most common building materials including: vinyl, metal, glass, wood, PVC, concrete, aluminum, and all types of siding. It spans gaps up to 2" wide, stays flexible, crackproof, paintable, and VOC-compliant. It can be used in interior and exterior applications. DuraMaster™ is available in 13 colors and is UV-resistant. DuraMaster™ offers 4X durability versus other high-performance acrylic latex sealants. \*Clear offers 25% joint movement.



Color	Part Number	Box Quantity
White	7920T32001	12
Black	7920T32011	12
Medium Bronze	7920T32021	12
Dark Bronze	7920T32031	12
Gray	7920T32041	12
Clay	7920T32051	12
Ironstone	7920T32061	12
Almond	7920T32071	12
Redwood	7920T32081	12
Wood Tone	7920T32091	12
Dark Brown	7920T32111	12
Tan	7920T32121	12
Clear	7920T32131	12
Crystal Clear	7920T44041	12

## Wood Filler Famowood



Fill



Sand



Stain

### Solvent Based

Color	Pint	Quart
Alder	79401100P	79401100Q
Ash	79401102P	79401102Q
Birch	79401106P	79401106Q
Fir/Pine	79401116P	79401116Q
Mahogany	79401122P	79401122Q
Maple	79401124P	79401124Q
Natural/ Tupelo/ White Pine	79401126P	79401126Q
Oak/Teak	79401128P	79401128Q
Red Oak/Cherry	79401134P	79401134Q
Redwood		79401136Q
Walnut	79401142P	79401142Q
White		79401144Q
Famoglaze		79401152Q

### Water Based

Color	Pint	1 Gallon	5 Gallons
Birch	79421106PWB		
Maple	79421124PWB	79421124GWB	
Natural	79421126PWB		
Red Oak	79421134PWB		
Walnut	79421142PWB		
White	79421144PWB		
White Pine	79421148PWB		794211485GWB



## Color Putty



### Water Based Color Putty

Color	4 OZ	1 LB
Briarwood	7946CP1404	
Brown Mahogany	7946CP1264	
Cherry	7946CP1184	
Dark Walnut	7946CP1304	
Ebony	7946CP1344	
Fruitwood	7946CP1104	
Honey Oak	7946CP1224	
Light Birch	7946CP1064	
Light Oak	7946CP1084	7946CP108
Natural	7946CP1024	7946CP102
Nutmeg	7946CP1364	7946CP136
Pecan	7946CP1384	
Redwood	7946CP1244	7946CP124
Teakwood	7946CP1444	
White	7946CP1004	7946CP100

### Water Based Color Putty Kit

4 oz Water Based Color Putty Kit  
Contains 16 colors for custom blending  
Part Number: 7946CPKIT4

### Oil Based Color Putty

Color	4 OZ
Briarwood	7945CP1404
Brown Mahogany	7945CP1264
Butternut	7945CP1164
Cherry	7945CP1184
Dark Walnut	7945CP1304
Ebony	7945CP1344
Fruitwood	7945CP1104
Light Birch	7945CP1064

Color	4 OZ
Honey Oak	7945CP1224
Light Oak	7945CP1084
Maple	7945CP1144
Natural	7945CP1024
Nutmeg	7945CP1364
Pecan	7945CP1384
Redwood	7945CP1244
Teakwood	7945CP1444
White	7945CP1004

### Oil Based Color Putty Kit

4 oz Oil Based Color Putty Kit  
Contains 16 colors for custom blending  
Part Number: 7945CPKIT4

## Wood Filler - Timbermate



Grain, trowel and crack filler, sanding sealer.  
Unlimited shelf life.  
Stainable.

### Water Based Wood Filler

Color	8 OZ	1 QT
Alder	7948TALD25	7948TALD2Q
Brazilian Cherry	7948TABC25	7948TABC2Q
Cherry		7948TBB2Q
Mahogany	7948TAAM25	7948TAAM2Q
Maple	7948TAMB25	7948TAMB2Q
Natural / Tint Base	7948TATB25	7948TATB2Q
Rustic / Ebony	7948TAE25	7948TAR2Q
Tasmanian Oak	7948TAO25	
Walnut	7948TAW25	7948TAW2Q
White	7948TAWH25	7948TAWH2Q
White Oak	7948TAWO25	7948TAWO2Q

Wood Filler

## Epoxy Putty



Size	Type	Part Number
1 Gallon	E800-A	7949E800A
1 Gallon	E800-B	7949E800B

## Spackle



Size	Type	Part Number
1 Pint	Onetime® Lightweight Spackle	7947R0548
1 Quart	Vinyl Spackling Compound	7947R0534

## Bondo

Light weight, tack-free filler with 2.75 oz hardener.  
White color.  
Works best on steel surfaces.



Size	Type	Part Number
1 Gallon	2-Part	3M07630800494
2.75 Ounce	Extra Hardener Blue	3M07630830753

## Putty Pencils

Wood Filler  
/Tape



1.6 oz Pencils

Putty Pencils are the easiest way yet to fill countersunk nail holes, joints, etc., and to repair gouges and scratches in interior woodwork and furniture. You can blend them together for custom matches. Use Putty Pencils on damaged woodwork to save expensive refinishing jobs. On new woodwork, use them after the last coat of finish has dried and hardened. Putty Pencils are a blend of six waxes saturated with rich colorants - much more than ordinary crayons can contain. By simply rubbing over a nail hole, joint or scratch, the Putty Pencil fills the repair with colorant and stays put. Wipe away excess with a cloth, and the job is complete. It's that quick and easy. In addition to woodwork, you can use Putty Pencils to repair leather (like scuffed shoes or belts) and vinyl. They can also be used creatively for any number of crafts projects.

Color	Part Number	Box Quantity
Black	79HF808117	10
Cherry	79HF808816	10
Colonial Maple	79HF808813	10
Dark Walnut	79HF808818	10
Early American	79HF808815	10
Golden Oak	79HF808814	10
Natural Pine	79HF808812	10
Red Mahogany	79HF808817	10
White	79HF808811	10

## Tape

### 3M™ Box Sealing Tape



Part Number	Size	Type	Color	Rolls Per Box
3M02120039809	2" x 110yd	305	Clear	36
3M02120015873	2" x 110yd	371	Clear	36

### Masking Tape



Part Number	Size	Type	Color	Rolls Per Box
3M05111564738	1/2" x 60yd	3M™ 201+	Tan	72
3M05111564739	3/4" x 60yd	3M™ 201+	Tan	48
3M05111564740	1" x 60yd	3M™ 201+	Tan	36
3M05111564741	1 1/2" x 60yd	3M™ 201+	Tan	24
3M05111564742	2" x 60yd	3M™ 201+	Tan	24
3M05111564743	3" x 60yd	3M™ 201+	Tan	12

### CP27 Blue Masking Tape



Part Number	Size	Type	Rolls Per Box
5304CP2712	3/4" x 60yd	CP27	48
5304CP2716	1" x 60yd	CP27	36
5304CP2720	1 1/2" x 60yd	CP27	24
5304CP2724	2" x 60yd	CP27	24



## Tape

### 3M™ Double Coated Foam Tape



Part Number	Size	Type	Color	Rolls Per Box
3M02120030423	1" x 36yd	4496	Black	9

### 3M™ Paper Masking Tape



Part Number	Size	Color	Rolls Per Box
3M05111541402	12" x 60yd	Brown	12
3M05113177399	12" x 60yd	Green	12
3M05111506904	18" x 60yd	Green	12

### 3M™ Duct Tape



Part Number	Size	Type	Color	Rolls Per Box
3M07630898119	2" x 60yd	DT11 Multipurpose	Black	24
3M05113106976	2" x 60yd	3900 Multipurpose	Silver	24
3M05113106975	2" x 60yd	3939 Heavy Duty	Silver	24

### 3M™ Aluminum Foil Tape 425



Part Number	Size	Type	Color	Rolls Per Box
3M93080311	2" x 60yd	#425 Foil	Silver	24

### Filament Strapping Tape



Part Number	Size	Brand	Rolls Per Box
530542008	1/2" x 60yd	Generic	72
3M02120086519	3/4" x 60yd	3M™	48

## Tape

### Bubble Wrap



Part Number	Size
5308DBP75012P12	12" x 750' x 1/8

### Foam Sheeting

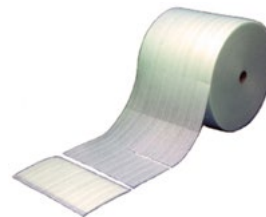

Foam sheeting is perforated at 12".

Part Number	Size
5308PAF06024900P12	24" x 900' x 1/16
5308PAF06036900P12	36" x 900' x 1/16
5308PAF12536450P12	36" x 450' x 1/8
5308PAF12548450P12	48" x 450' x 1/8

## Tape

### Tape Dispenser



Part Number	Size	Type
3M05113106997	2"	Tartan™ Pistol Grip Box Sealing Tape Dispenser HB903

### Stretch Wrap



Part Number	Size	Gauge	Rolls Per Box
53030380	3" x 1,000ft	80	18
53030580	5" x 1,000ft	80	12
53031580SW	15" x 1,500ft	80	4
53031880SW	18" x 1,500ft	80	4

### Twine



Spiral Wrap multi-filament tying twine is made of parallel untwisted strands, bound together in a spiral jacket.

Part Number	Size	Rolls Per Box
86CWC40	1/2" x 3900'	4

## Abrasives



### 3M™ Sanding Sheets 9 x 11 - 426U

Part Number	Grit	Backing	Pack Per Box
3M05112586949	150	A wt Paper	100
3M05112586953	180	A wt Paper	100
3M05114127848	220	A wt Paper	100
3M05114127852	320	A wt Paper	100

### 3M™ Sanding Sheets 9 x 11 - 216U

Part Number	Grit	Backing	Pack Per Box
3M05113102546	150	A wt Paper	100
3M05113102545	180	A wt Paper	100
3M05113102541	320	A wt Paper	100

Abrasives

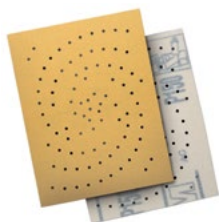

### 3M™ Clean Sanding Sheets 3 x 4 - 236U

Part Number	Size	Grit	Type	Box Quantity
3M05114120949	3" x 4"	180	236U Hookit Clean Sanding	50
3M05114120950	3" x 4"	220	236U Hookit Clean Sanding	50
3M05114120951	3" x 4"	320	236U Hookit Clean Sanding	50



### 9 x 11 Aluminum Oxide Sterated

Grit	Backing Weight	Part Number	Sheets Per Pack
80	A Weight Paper	740380ANL	100
120	A Weight Paper	7403120ANL	100
150	A Weight Paper	7403150ANL	100
320	A Weight Paper	7403320ANL	100

## Abrasives

### 3M™ Random Orbital Sanders



Max RPM: 12,000  
Motor HW (W): .28  
Airflow Rate SCFM (LPM): 17

### 3M™ 5" Orbital Sanders

Part Number	Vacuum	Orbit	Length	Height	Pad Included
3M05114120317	Non-Vac	3/16"	6"	3"	Stikit™ Pad

### 3M™ 6" Orbital Sanders

Part Number	Vacuum	Orbit	Length	Height	Pad Included
3M05114120325	Non-Vac	3/16"	6"	3"	Stikit™ Pad

### 3M™ 5" Random Orbital Sanders, Elite Series



Alloy steel curved-throttle lever with built-in wrist support.  
3M gripping material molded into the interchangeable comfort grip.  
Conveniently located speed control dial.  
Internal muffler.  
Available in 3/32", 3/16", and 5/16" orbits

Max RPM: 12,000  
Motor HW (W): .28  
Airflow Rate SCFM (LPM): 17

Part Number	Vacuum	Orbit	Length	Height	Pad Included
3M05114128498	Non-Vac	3/32"	7"	4"	Stikit™ Pad
3M05114128497	Non-Vac	3/16"	7"	4"	Stikit™ Pad

## Air Tool Lubricant



Used to keep pneumatic air tools running efficiently. Use 2-3 drops at the end of each day, or as needed, to maintain tool performance.  
4 fluid ounces  
12 per case

Part Number: 7495Z4OZ

### 3M™ Clean Sanding Filter Bag



10.88" W x 26.88" L x 12.75" H  
10 per box  
Part Number: 3M05114120452



## Abrasives

### 3M™ Muffler Replacement Parts



Part Number	Description	For	Pack Per Box
3M05114155171	Inlet Bushing Assembly	Elite Sander	1
3M05114155179	Muffler	Elite Sander	1
3M05114155191	Internal Muffler Assembly	Elite Sander	1
3M05114155201	End Cap	Elite Sander	1
3M05111528121	Internal Muffler	Orbital Sander	20
3M05111528122	Muffler Insert	Orbital Sander	20
3M05111528138	Muffler Housing	Orbital Sander	20

## Backup Pads

### 3M™ Backup Pads



Part Number	Size	Type	Pack Per Box
3M05114120351	5" x 3/8"	Low Profile Stikit™	10
3M05114405575	5" x 3/4"	Stikit™	10
3M05114120442	5" x 3/8"	Dust Free Low Profile Stikit™ 5 Vent	10
3M05114120352	5" x 3/8"	Low Profile Hookit™	10
3M05113105775	5" x 3/4"	Hookit™	10
3M05113105855	5" x 3/8"	Dust Free Low Profile Hookit™ 5 Vent	10
3M05114405576	6" x 3/4"	Stikit™	10
3M05114120355	6" x 3/8"	Low Profile Hookit™	10
3M05114128709	6" x 3/4"	Hookit™	10
3M05114125122	6" x 3/8"	Dust Free Low Profile Hookit™ 5 Vent	10
3M05113105876	6" x 3/4"	Hookit™ 6 Vent	10
3M05114120432	3" x 4" x 1/2"	Stikit™	10

## Abrasives



### SurfPrep 5" Ray Electric Sander



RPM: 4,000, 7,000, 9,000 & 10,000  
Voltage: 110-120V  
Watts: 150-350

Part Number	Vacuum	Orbit	Length	Height	Pad Included
SPES5HL316	Non-Vac	3/16"	8.86"	3.94"	Hook & Loop

### SurfPrep 5" Trident Air Sander



Max RPM: 12,000  
Power: 0.28 HP  
Airflow Rate SCFM (LPM): 17

Abrasives

Part Number	Vacuum	Orbit	Length	Height	Pad Included
SPTS5HL316	Non-Vac	3/16"	7"	3.9"	Hook & Loop
SPTS5HL332	Non-Vac	3/32"	7"	3.9"	Hook & Loop

### SurfPrep 3" x 4" Ray Electric Sander



RPM: 4,000, 7,000 & 9,000  
Voltage: 110-120V  
Watts: 150-350

Part Number	Vacuum	Size	Length	Height	Pad Included
SPES3X4	Non-Vac	3" x 4"	7.32"	4.17"	Hook & Loop

### SurfPrep 3" x 4" Storm Air Sander



Max RPM: 10,000  
Power: 0.24 HP  
Airflow Rate SCFM (LPM): 16

Part Number	Vacuum	Size	Length	Height	Pad Included
SPS3X4	Non-Vac	3" x 4"	5.5"	3.3"	Hook & Loop



## Abrasives



### SurfPrep Backup Pads



Part Number	Size	Type	Pack Per Box
SPBP5HL	5"	Hook & Loop	1
SPBP3X4	3" x 4"	Hook & Loop	1
SPBP3X4VAC	3" x 4"	Hook & Loop (4 Holes for Vacuum)	1

### Sanding Discs



### SurfPrep 5" Velcro Film Discs

Part Number	Size	Grit	Backing	Box Quantity
SP5HLF080	5"	80	Velcro Film	100
SP5HLF100	5"	100	Velcro Film	100
SP5HLF120	5"	120	Velcro Film	100
SP5HLF150	5"	150	Velcro Film	100
SP5HLF180	5"	180	Velcro Film	100
SP5HLF220	5"	220	Velcro Film	100
SP5HLF320	5"	320	Velcro Film	100
SP5HLF400	5"	400	Velcro Film	100



### SurfPrep 5" Paper Velcro Discs

Part Number	Size	Grit	Backing	Box Quantity
SP5HLLPB080	5"	80	Paper Velcro	100
SP5HLLPB100	5"	100	Paper Velcro	100
SP5HLLPB120	5"	120	Paper Velcro	100
SP5HLLPB150	5"	150	Paper Velcro	100
SP5HLLPB180	5"	180	Paper Velcro	100
SP5HLLPB220	5"	220	Paper Velcro	100
SP5HLLPB320	5"	320	Paper Velcro	100
SP5HLLPB400	5"	400	Paper Velcro	100

## Abrasives



### SurfPrep 3" x 4" Velcro Film Vented Sheets

Part Number	Size	Grit	Type	Box Quantity
SP3X4HLF0804	3" x 4"	80	Velcro Film Vented	100
SP3X4HLF1004	3" x 4"	100	Velcro Film Vented	100
SP3X4HLF1204	3" x 4"	120	Velcro Film Vented	100
SP3X4HLF1504	3" x 4"	150	Velcro Film Vented	100
SP3X4HLF1804	3" x 4"	180	Velcro Film Vented	100
SP3X4HLF2204	3" x 4"	220	Velcro Film Vented	100
SP3X4HLF3204	3" x 4"	320	Velcro Film Vented	100
SP3X4HLF4004	3" x 4"	400	Velcro Film Vented	100



### SurfPrep 3" x 4" Velcro Paper Vented Sheets

Part Number	Size	Grit	Type	Box Quantity
SP3X4HLLPB0804	3" x 4"	80	Velcro Paper Vented	100
SP3X4HLLPB1004	3" x 4"	100	Velcro Paper Vented	100
SP3X4HLLPB1204	3" x 4"	120	Velcro Paper Vented	100
SP3X4HLLPB1504	3" x 4"	150	Velcro Paper Vented	100
SP3X4HLLPB1804	3" x 4"	180	Velcro Paper Vented	100
SP3X4HLLPB2204	3" x 4"	220	Velcro Paper Vented	100
SP3X4HLLPB3204	3" x 4"	320	Velcro Paper Vented	100
SP3X4HLLPB4004	3" x 4"	400	Velcro Paper Vented	100

### SurfPrep LED Inspection Light



LED Inspection Light  
24" length.  
24 light emitting diodes.  
Visor included.  
Part Number: SPIL24

Abrasives



## Abrasives

### 3M™ Sanding Sponges



Part Number	Size	Grade	Pack Per Box
3M05111506964	5 1/2" x 4 1/2" x 3/16"	Super Fine	250
3M05111506965	5 1/2" x 4 1/2" x 3/16"	Fine	250
3M05111506966	5 1/2" x 4 1/2" x 3/16"	Medium	250

### 3M™ Hand Sanding Sponge



Part Number	Size	Grit	Pack Per Case
3M05111506968	1" x 2 3/4" x 3 3/4"	Fine	250
3M0511151066	1/2" x 3 3/4" x 4 3/4"	Fine	250

### Steel Wool - 5 Pound Rolls



#0000  
Part Number: 7405SW0000

#2  
Part Number: 7405SW2

### 3M™ All-Purpose Tack Pad



Part Number	Size	Color	Type	Pack Per Box
3M05113107910	6" x 9"	White	Foam	6

## Abrasives

### 3M™ Scotch-Brite™ Hand Pads



Part Number	Size	Color	Product Number	Type	Pack Per Box
3M04801104229	6" x 9"	Maroon	7447	Very Fine	60
3M04801104028	6" x 9"	Light Grey	7448	Ultra Fine	60
3M04801118453	6" x 9"	Grey	7446	Medium	40
3M05113107445	6" x 9"	Gold	7445	Light Duty	60
3M04801118451	6" x 9"	Tan	7440	Heavy Duty	40

### 3M™ Scotch-Brite™ Hookit Discs



Abrasives

Part Number	Size	Color	Type	Pack Per Box
3M04801129293	6"	Maroon	Very Fine	40
3M04801129295	6"	Gray	Ultra Fine	40
3M04801130037	11 1/4"	Maroon	Very Fine	25
3M04801130038	11 1/4"	Gray	Ultra Fine	25



### 3M™ Hookit™ Gold Film Sanding Discs - 255L

Part Number	Size	Grit	Backing	Pack Per Box
3M05113100967	5"	80	Film	75
3M05113100966	5"	100	Film	100
3M05113100965	5"	120	Film	100
3M05113100964	5"	150	Film	100
3M05113100963	5"	180	Film	100
3M05113100962	5"	220	Film	100

## Abrasives



### 3M™ Stikit™ Gold Film Sanding Discs - 255L

Part Number	Size	Grit	Backing	Pack Per Roll
3M05114482471	5"	80	Film	100
3M05114482469	5"	120	Film	125
3M05114482468	5"	150	Film	125
3M05114482467	5"	180	Film	125
3M05114482466	5"	220	Film	125
3M05114482463	5"	320	Film	125

## Abrasives

### 3M™ Hookit™ Discs - 732U

Part Number	Size	Grit	Backing	Pack Per Box
3M05112586842	5"	80	C wt Paper	250
3M05112586843	5"	120	C wt Paper	250
3M07630864260	5"	150	C wt Paper	250
3M07630864266	5"	180	C wt Paper	250
3M07630864272	5"	220	C wt Paper	250

### 3M™ Stikit™ Discs - 732U

Part Number	Size	Grit	Backing	Pack Per Roll
3M05112586826	5"	80	C wt Paper	250
3M05112586827	5"	120	C wt Paper	250
3M07630864277	5"	150	C wt Paper	250
3M07630864281	5"	180	C wt Paper	250
3M07630864285	5"	220	C wt Paper	250

### 3M™ Stikit™ Cloth Discs - 202DZ

Part Number	Size	Grit	Backing	Pack Per Box
3M05111150450	5"	80	J Weight Cloth	250
3M05111150451	5"	100	J Weight Cloth	250
3M05111150452	5"	120	J Weight Cloth	250
3M05111150453	5"	150	J Weight Cloth	250
3M05111150454	5"	180	J Weight Cloth	250

## Abrasives

### Solid Surface



### 3M™ Hookit™ Vented Sanding Discs - 268L

Part Number	Size	Grit	Backing	Pack Per Box
3M05111154554	6"	30 Micron	Film	100
3M05111904062	6"	60 Micron	Film	100
3M05111904061	6"	100 Micron	Film	100

### 3M™ Microfinishing PSA Film Type D Discs - 268L

Part Number	Size	Grit	Backing	Pack Per Box
3M05114476975	5"	30 Micron	Film	100
3M05114414975	5"	60 Micron	Film	100
3M05114480205	5"	100 Micron	Film	100

Part Number	Size	Grit	Backing	Pack Per Box
3M05114414974	6"	60 Micron	Film	100
3M05114480204	6"	100 Micron	Film	100

For Finish Recommendations ask your Salesman or go to the 3M Catalog

### 5" Gold - "C" Weight Aluminum Oxide with Sterate Discs

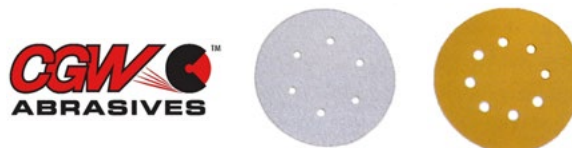

Grit	Velcro 5 Hole Vented	Velcro 8 Hole Vented	Pack Per Box
80		741005808VV	100
120		7410051208VV	100
150		7410051508VV	100
180	741005180VV	7410051808VV	100
220	741005220VV	7410052208VV	100



## Abrasives

### 5" Gold - "C" Weight Aluminum Oxide with Sterate Discs



Grit	PSA	Vented PSA	Pack Per Box
60	74100560C		100
80	74100580C	74100580V	100
100	741005100C		100
120	741005120C	741005120V	100
150	741005150C	741005150V	100
180	741005180C		100
220	741005220C		100

### 5" U612 - "A" Weight Aluminum Oxide with Sterate Discs



Grit	PSA	Vented PSA	Velcro	Pack Per Box
80	74100580U		74100580UVL	100
100	741005100U		741005100UVL	100
120	741005120U		741005120UVL	100
150	741005150U	741005150UV	741005150UVL	100
180	741005180U	741005180UV	741005180UVL	100
220	741005220U		741005220UVL	100
320	741005320U		741005320UVL	100
400			741005400UVL	100

## Abrasives

### 6" Aluminum Oxide Sterated



Grit	PSA	Velcro 6 Hole Vented	Pack Per Box
80	74100680C	741006806VV	100
100	741006100C		100
120	741006120C	7410061206VV	100
150	741006150C	7410061506VV	100
180	741006180C	7410061806VV	100
220	741006220C	7410062206VV	100
320	741006320C	7410063206VV	100



## Abrasives

### 3M™ Wide Belts - 340D

Grit	37" x 60"	52" x 103"	Pack Per Box
80	3M05111566642		3
100	3M05111566643		5
120	3M05111566644	3M05111566665	5
150	3M05114434289		5
180	3M05114471591	3M05111921280	5

## Abrasives

### Standard Size Belts - Aluminum Oxide



Grit	3" x 18"	3" x 21"	3" x 24"	Box Quantity
40		7401032140	7401032440	10
50		7401032150	7401032450	10
60	7401031860	7401032160	7401032460	10
80	7401031880	7401032180	7401032480	10
100		74010321100	74010324100	10
120	74010318120	74010321120	74010324120	10
150		74010321150	74010324150	10

## Abrasives

### Wide Belts - Aluminum Oxide



### XW341 - Cloth Sanding Belts

Grit	43" x 75"	52" x 103"	Box Quantity
80		74015210380XW341	5
100		740152103100XW341	5
120	74014375120XW341		5
150	74014375150XW341		5

## Abrasives

Grit	4" x 24"	4" x 132"	6" x 148"	Box Quantity
40	7401042440	74010413240		10
50	7401042450			10
60	7401042460	74010413260		10
80	7401042480	74010413280		10
100	74010424100	740104132100	74010648100	10
120	74010424120	740104132120		10
150	74010424150	740104132150	74010648150	10

### B347 - Paper Sanding Belts

Grit	43" x 75"	Box Quantity
150	74014375150B347	5
180	74014375180B347	5
220	74014375220B347	5
320	74014375320B347	5

### Specialty Size Belts - Aluminum Oxide



Grit	6" x 89"	6" x 108"	6" x 132"	8" x 148"	Box Quantity
80	7401068980		74010613280	74010814880	10
100	74010689100		740106132100	740108148100	10
150	74010689150	740106108120	740106132150		10



## File Card With Brush



Used to clean files, files last longer when kept properly cleaned. Excess build-up can cause clogging resulting in slipping, scratching, or other filing inefficiencies.  
Sold Individually

Part Number: 5240S73993500

## Simonds Files



### Black Maxi-Sharp (Specially Treated With Black Oxide) All Purpose



The built in handle provides maximum versatility for a wide range of applications. All purpose files feature a double cut on one side, a single cut on the other side, have one edge cut and one edge safe (uncut) for shoulder filing, and are parallel in width and thickness.

Packed 12 per Box

8 Inch Part Number: 5240S78187600

10 Inch Part Number: 5240S7818810

### Round



Intended for enlarging and rounding out circular openings or concave surfaces. Round files are double cut and tapered toward the point in width and thickness. (Often called "Rat Files")

Packed 12 per Box

6 Inch Part Number: 5240S7339600

## American Pattern

### All Purpose



The built in handle provides maximum versatility for a wide range of applications. All purpose files feature a double cut on one side, a single cut on the other side, have one edge cut and one edge safe (uncut) for shoulder filing, and are parallel in width and thickness.

Packed 12 per Box

8 Inch Part Number: 5240S7318750

10 Inch Part Number: 5240S7318800

## Reinforced Cut-Off Wheels Type 1



Strong resin bond.  
High quality grain.  
Cuts square and resists breakage.  
Long life and burr free cutting.  
Fast cut rate.

For: electrical powered portable saws used for cutting structural steel, solids, pipe/tubing as well as concrete, brick, and masonry.

Part Number	Type	Size	Box Quantity
7411COAB179072	Masonry	7" x 1/8" x 5/8"	50
7411CGW59109	Metal	7" x 3/32" x 5/8"	10
7411COAB178122	Metal	12" x 1/8" x 1"	10
7411COAB178142	Metal	14" x 1/8" x 1"	10
7411COAB178141	Metal	14" x 7/64" x 1"	10

## 3M™ Resin Fibre Discs



Fiber discs are heavy-duty discs ideal for weld removal, grinding and blending large and small areas of metal surfaces. They feature a tough, stiff backing made from vulcanized fiber that resist wear and can handle tough grinding applications.

Laminate Files  
/Wheels & Discs

Part Number	Size	Grit	Material	Box Quantity
3M05114485962	4 1/2" x 7/8"	60	501C	100
3M05111150416	4 1/2" x 7/8"	80	501C	100
3M05114127448	5" x 7/8"	36	987C	100
3M05114127400	4 1/2" x 7/8"	36	982C Cubitron™ II	100
3M05114127404	5" x 5/8"-11	36	982C Cubitron™ II	100
3M05114127402	7" x 7/8"	36	982C Cubitron™ II	100

## CGW Resin Fibre Discs



Aluminum Oxide Resin Fibre Discs

Part Number	Size	Grit	Type	Box Quantity
7411CGW48012	4 1/2" x 7/8"	36	RFD	25
7411CGW48016	4 1/2" x 7/8"	80	RFD	25
7411CGW48106	4 1/2" x 7/8"	80	Zirconia RFD	25
7411CGW48022	5" x 7/8"	36	RFD	25
7411CGW48032	7" x 7/8"	36	RFD	25

## Flap Discs

Recommended for aggressive use and heavy duty applications. Active grinding agent provides cool cutting with light pressure. Special optimized resin bond offers maximum cutting capacity, strong edge stability and long life.

### 3M™ Flap Discs



Part Number	Size	Grit	Type	Box Quantity
3M05111161192	4 1/2" x 5/8-11	60	T27 947D	10
3M63806005903	4 1/2" x 7/8"	40	T27 769F	10
3M07630864399	7" x 5/8-11	80	T29 969F Cubitron™ II	10

### CGW Z3® Flap Discs

Wheels & Discs



Premium Zirconia Alumina grain with a poly/cotton heat treated backing. The poly/cotton combination provides low stretch and strength for the high Zirconia concentration that Z3® contains.

Part Number	Size	Grit	Type	Box Quantity
7411CGW42311	4 1/2" x 5/8-11	36	T27	10
7411CGW42305	4 1/2" x 7/8"	80	T27	10
7411CGW42332	4 1/2" x 5/8-11	40	T29	10
7411CGW42334	4 1/2" x 5/8-11	60	T29	10
7411CGW42361	4 1/2" x 7/8"	36	T29 XL	10
7411CGW42342	4 1/2" x 7/8"	40	T27 XL	10
7411CGW36317	4 1/2" x 7/8"	60	T27 XXL	10
7411CGW42711	7" x 5/8-11	36	T27 Regular	10

## CGW Quick Change Discs

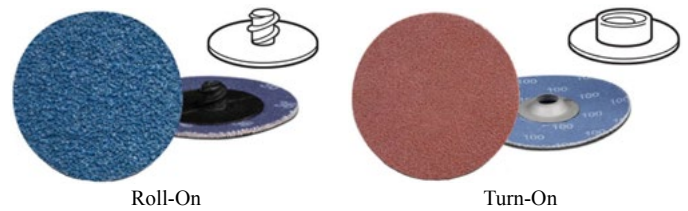

Part Number	Size	Grit	Box Quantity
7411CGW59503	2" QC Roll-On	SC CRS Brown	50
7411CGW59527	2" QC Roll-On	50 AO	50
7411CGW59528	2" QC Roll-On	60 AO	50
7411CGW59529	2" QC Roll-On	80 AO	50
7411CGW59611	2" QC Turn-On	SC MED Maroon	50
7411CGW59634	2" QC Turn-On	36 AO	50
7411CGW59638	2" QC Turn-On	80 AO	50
7411CGW59646	3" QC Turn-On	36 AO	25
7411CGW59574	3" QC Roll-On	80 Zirconia	25
7411CGW59543	3" QC Roll-On	120 AO	25
7411CGW59509	4" QC Roll-On	SC CRS Brown	25

## CGW Cutting & Grinding Wheels



T27 Cut-Off



T27 Grinding

Part Number	Size	Type	Material	Box Quantity
7411CGW35514	4 1/2" x .045" x 7/8"	T1 Cut-Off	ZA36 Rigid	25
7411CGW35517	6" x .045" x 7/8"	T1 Cut-Off	ZA36 Rigid	25
7411CGW36256	4 1/2" x 1/4" x 5/8-11	T27 Grinding	A24 RBF	10
7411CGW35620	4 1/2" x 1/4" x 7/8"	T27 Grinding	A24R AO	25
7411CGW35643	7" x 1/4" x 5/8-11	T27 Grinding	A24 NBF	10
7411CGW45219	4 1/2" x 3/32" x 5/8-11	T27 Cut-Off/Grinding	A36S	10
7411CGW59109	7" x 3/32" x 5/8"	Cut-Off	A24 RBF	25

## 3M™ Cutting & Grinding Wheels



Cubitron™ II

Scotch-Brite™

Part Number	Size	Type	Material	Box Quantity
3M07630864320	4 1/2" x 1/4" x 5/8-11	T27 Grinding	Cubitron™ II	20
3M05111578466	4 1/2" x 1/4" x 7/8"	T27 Grinding	Cubitron™ II	20
3M04671982279	4 1/2" x 1/8" x 7/8"	T27 Cut/Grind	Cubitron™ II	20
3M07630864319	7" x 1/4" x 5/8-11	T27 Cut/Grind	Cubitron™ II	20
3M04801160349	4 1/2" x 5/8-11	A CRS Grnd/Blend	Scotch-Brite™	25
3M63806005588	4 1/2" x 5/8-11	X CRS Strip/Clean	Scotch-Brite™	25
3M05111150445	7" x 1/8" x 7/8"	T1 Grinding	Green Corp	20

## CGW Flap Disc



Surface conditioning flap discs.  
Use with right angle grinder.

Part Number	Size	Grit	Type	Box Quantity
7411CGW70120	4 1/2" x 7/8"	Coarse	T29	10

## CGW Air Cooled Rubber Backup Pad



Rubber back up pad with standard spiral pattern, without nut.  
Use with coarse grits.

Part Number	Size	Type	Material	Box Quantity
7411CGW48220	4 1/2" x 5/8-11	Medium Back Up Pad W/O Nut	Rubber	1

## Amana Router Bits



Ask about our Amana CNC Bits



## Straight Bits Single Flute

Sold Individually



Part Number	Cutting Diameter Inches	Cutting Length Inches	Shank Diameter Inches	Overall Length Inches
5224A45312	1/2"	2"	1/2"	4"

Wheels & Discs  
/Bits & Blades

## Straight Bits 2 Flute

Sold Individually



Part Number	Cutting Diameter Inches	Cutting Length Inches	Shank Diameter Inches	Overall Length Inches
5224A45190	1/16"	3/16"	1/4"	1 5/8"
5224A45200	1/8"	7/16"	1/4"	2"
5224A45202	3/16"	7/16"	1/4"	2"
5224A45208	1/4"	3/4"	1/4"	2"
5224A45211	1/4"	1"	1/4"	2 7/8"
5224A45218	3/8"	1"	1/4"	2 1/4"
5224A45226	1/2"	1"	1/4"	2 1/8"
5224A45228	5/8"	3/4"	1/4"	2"
5224A45230	3/4"	3/4"	1/4"	2"





## Straight Plunge Bits 2 Flute

Sold Individually



Part Number	Cutting Diameter Inches	Cutting Length Inches	Shank Diameter Inches	Overall Length Inches
5224A45414	3/8"	1"	1/2"	2 3/4"
5224A45418	1/2"	1"	1/2"	2 5/8"
5224A45420	1/2"	1 1/4"	1/2"	2 7/8"
5224A45422	1/2"	1 1/2"	1/2"	3 1/8"
5224A45426	1/2"	2"	1/2"	4 1/4"
5224A45427	1/2"	2 1/4"	1/2"	4 1/2"
5224A45445	23/32"	1 1/4"	1/2"	2 7/8"
5224A45448	1"	1 1/4"	1/2"	2 7/8"

## Panel Pilot Concave Grind

Single Flute, Sold Individually

Bits & Blades



Part Number	Cutting Diameter Inches	Cutting Length Inches	Shank Diameter Inches	Overall Length Inches
5224A45508	3/8"	1"	3/8"	3"

## Mortising Bits

Sold Individually



Part Number	Cutting Diameter Inches	Cutting Length Inches	Shank Diameter Inches	Overall Length Inches
5224A45500	1/2"	3/4"	1/4"	2"
5224A45502	5/8"	3/4"	1/4"	2"



## 2-Piece Stile and Rail Sets

Sold Individually

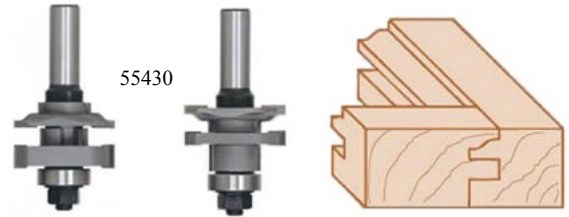

Part Number	Cutting Diameter Inches	Type	Radius	Shank Diameter Inches	Overall Length Inches
5224A55430	1 5/8"	Ogee	1/4"	1/2"	3 5/16"

## Raised Panel Bits

Sold Individually



Part Number	Overall Diameter Inches	Cutting Depth Inches	Radius or Angle	Shank Diameter Inches	Overall Length Inches
5224A54117	3 3/8"	1 7/16"	15°	1/2"	2 3/8"
5224A54118	2 5/8"	1 1/16"	3/4"	1/2"	2 1/2"
5224A54119	3 3/8"	1 7/16"	1 9/16"	1/2"	2 3/8"
5224A54121	3 3/8"	1 7/16"	7/8"	1/2"	2 1/2"

## Corner Beading Bit

Sold Individually



Part Number	Radius Inches	Cutting Diameter Inches	Cutting Length Inches	Shank Diameter Inches	Overall Length Inches
5224A54160	1/8"	7/8"	9/16"	1/4"	2 1/8"



## 4 Wing Bevel Trim Cutter Assembly

Sold Individually



Part Number	Type Cut	Shank Diameter Inches	Cutting Diameter Inches	Cutting Length Inches	Overall Length Inches
5224A47400	Flush	1/4"	7/8"	1/4"	2 3/8"

## Dado Clean-Out Bit

2 Flute, Sold Individually



Part Number	Cutting Diameter Inches	Cutting Length Inches	Shank Diameter Inches	Overall Length Inches	Replace Bearing Part #	Replace Collar Part #
5224A45460S	1/2"	1/4"	1/4"	1 5/8"	A47701	A47724
5224A45474S	9/16"	3/8"	1/4"	1 27/32"	A47753	A47724

## Top Bearing Trim Bits

Sold Individually



Part Number	Cutting Diameter Inches	Cutting Length Inches	Shank Diameter Inches	Overall Length Inches	Replace Bearing Part #	Replace Collar Part #
5224A45460	1/2"	1"	1/4"	2 1/2"	A47721	A47739
5224A45461	1/2"	1 1/4"	1/4"	2 3/4"	A47701	A47724
5224A45462	5/8"	1"	1/4"	2 3/4"	A47712	A47724
5224A45464	3/4"	1"	1/4"	2 1/2"	A47714	A47724
5224A45487	1/2"	1/2"	1/4"	2"	A47701	A47724



## Top Bearing Trim Bits

Sold Individually

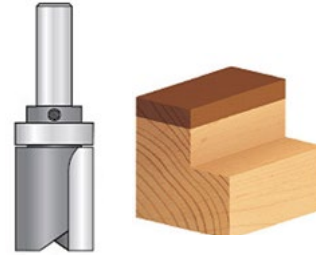

Part Number	Cutting Diameter Inches	Cutting Length Inches	Shank Diameter Inches	Overall Length Inches	Replace Bearing Part #	Replace Collar Part #
5224A45463	3/4"	1"	1/2"	3"	A47721	A47739
5224A45465	3/4"	1 3/4"	1/2"	3 3/4"	A47721	A47739
5224A45467	1"	1 3/4"	1/2"	3 3/4"	A47754	A47739
5224A45468	1 1/8"	1 1/2"	1/2"	3 1/2"	A47738	A47740
5224A45551	1 1/8"	2"	1/2"	4"	A47738	A47740

## Down Shear Face Plunge Template With Upper Ball Bearing

Sold Individually



Part Number	Cutting Diameter Inches	Cutting Length Inches	Shank Diameter Inches	Replace Bearing Part #	Replace Collar Part #
5224A45364	3/4"	2"	1/2"	A47721	A47739

Bits & Blades



## Rabbet Bits With Ball Bearing

Sold Individually



Part Number	Cutting Diameter Inches	Rabbet Length Inches	Shank Diameter Inches	Depth of Rabbet Inches	Overall Length Inches
5224A49300	1 1/4"	1/2"	1/4"	3/8"	2"
5224A49302	1 1/4"	1/2"	1/2"	3/8"	2 3/8"

## Multi-Rabbet Bits With Ball Bearing Guide

Sold Individually



Bits & Blades

Part Number	Cutting Diameter Inches	Rabbet Length Inches	Shank Diameter Inches	Depth of Rabbet Inches	Overall Length Inches
5224A49340	1 3/8"	1/2"	1/4"	1/8", 1/4", 5/16", 3/8", 7/16", 1/2"	2"

## Laminate Trim Bits

Sold Individually

### Flush Single Flute Panel Pilot

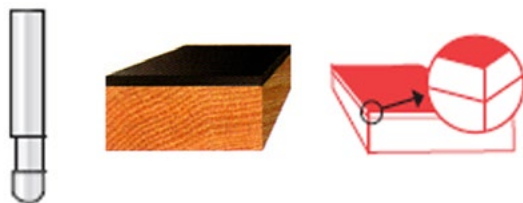

Part Number	Shank Diameter Inches	Cutting Diameter Inches	Cutting Length Inches	Overall Length Inches
5224A51200	1/4"	1/4"	1/4"	1 1/2"



## Laminate Trim Bits

Sold Individually

### 7 Degree Single Flute Panel Pilot

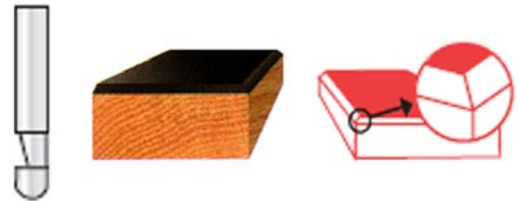

Part Number	Shank Diameter Inches	Cutting Diameter Inches	Cutting Length Inches	Overall Length Inches
5224A51202	1/4"	1/4"	1/4"	1 1/2"

## Flush Trim Bits With Ball Bearing Guide

Sold Individually

2-Flute



Part Number	Cutting Diameter Inches	Cutting Length Inches	Shank Diameter Inches	Overall Length Inches
5224A47090	1/4"	1/2"	1/4"	2 1/4"
5224A47092	1/4"	1"	1/4"	2 1/2"
5224A47100	3/8"	1"	1/4"	2 5/8"
5224A47102	3/8"	1/2"	1/4"	2 1/8"
5224A47103	3/8"	1"	3/8"	2 7/8"
5224A47104	1/2"	1"	1/4"	2 5/8"
5224A47106	1/2"	1/2"	1/4"	2 1/4"
5224A47108	1/2"	1"	1/2"	3 1/4"
5224A47110	1/2"	1/2"	1/2"	2 3/4"

3-Flute

Part Number	Cutting Diameter Inches	Cutting Length Inches	Shank Diameter Inches	Overall Length Inches
5224A47114	1/2"	1"	1/4"	2 5/8"
5224A47116	1/2"	1/2"	1/4"	2"
5224A47118	1/2"	1"	1/2"	3 1/4"



## Flush Trim Bits Extra Long With Ball Bearing Guide

Sold Individually

2-Flute



Part Number	Cutting Diameter Inches	Cutting Length Inches	Shank Diameter Inches	Overall Length Inches
5224A47124	1/2"	1 1/2"	1/2"	3 7/8"
5224A47126	1/2"	2"	1/2"	4 1/4"

## Bevel Trim With Ball Bearing Guide

Sold Individually



Part Number	Type Cut	Cutting Diameter Inches	Cutting Length Inches	Shank Diameter Inches	Overall Length Inches
5224A47200	15 Degree	5/8"	9/32"	1/4"	1 7/8"

## V Groove Bits

Sold Individually



Part Number	Angle	Cutting Diameter Inches	Cutting Length Inches	Shank Diameter Inches	Overall Length Inches
5224A45700	90°	3/8"	7/16"	1/4"	1 5/8"
5224A45702	90°	3/8"	7/16"	1/2"	2"
5224A45704	90°	1/2"	1/2"	1/4"	1 5/8"
5224A45705	60°	1/2"	5/8"	1/2"	2 1/4"



## 3 Wing Slotting Cutters

Sold Individually



Part Number	Number of Wings	Cutter Diameter Inches	Kerf Inches	Bore Inches
5224A53200	3	1 7/8"	1/16"	5/16"
5224A53206	3	1 7/8"	1/8"	5/16"

## Slot Cutter Assembly

Sold Individually



Bits & Blades

Part Number	Number of Wings	Cutter Diameter Inches	Cutting Length Inches	Shank Diameter Inches	Overall Length Inches
5224A53400	3	1 7/8"	1/16"	1/4"	2 3/8"
5224A53406	3	1 7/8"	1/8"	1/4"	2 3/8"
5224A534061	3	1 7/8"	1/8"	1/2"	2 3/8"
5224A53410	3	1 7/8"	1/4"	1/4"	2 3/8"

## Roman Ogee Bits With Ball Bearing Guide

2 Flute, Sold Individually



Part Number	Radius Inches	Cutting Diameter Inches	Cutting Length Inches	Shank Diameter Inches	Overall Length Inches
5224A49200	5/32"	1"	5/8"	1/4"	2 1/8"
5224A49204	1/4"	1 3/8"	7/8"	1/4"	2 1/4"



### Core Box Bits

2 Flute, Sold Individually



Part Number	Cutting Diameter Inches	Radius Inches	Cutting Length Inches	Shank Diameter Inches	Overall Length Inches
5224A45904	1/4"	1/8"	1/4"	1/4"	1 5/8"
5224A45906	3/8"	3/16"	1/4"	1/4"	1 1/2"
5224A45910	1/2"	1/4"	3/8"	1/4"	1 1/2"
5224A45912	1/2"	1/4"	3/8"	1/2"	2 1/8"
5224A45918	3/4"	3/8"	7/16"	1/4"	1 3/4"
5224A45920	3/4"	3/8"	7/16"	1/2"	2"
5224A45924	1"	1/2"	5/8"	1/4"	1 3/4"

### Cove Bits With Ball Bearing Guide

2 Flute, Sold Individually

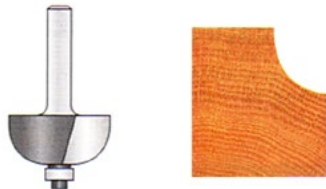

Part Number	Radius Inches	Cutting Diameter Inches	Cutting Length Inches	Shank Diameter Inches	Overall Length Inches
5224A49104	1/4"	7/8"	9/16"	1/4"	2"
5224A49112	3/8"	1 1/8"	9/16"	1/4"	2"
5224A49116	1/2"	1 3/8"	3/4"	1/4"	2 1/4"
5224A49118	1/2"	1 3/8"	3/4"	1/2"	2 1/2"

Bits & Blades



### Corner Rounding Bits With Ball Bearing Guide

2 Flute, Sold Individually

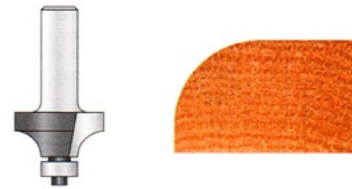

Part Number	Cutting Diameter Inches	Radius Inches	Cutting Length Inches	Shank Diameter Inches	Overall Length Inches
5224A49492	5/8"	1/16"	5/16"	1/4"	1 3/4"
5224A49496	3/4"	1/8"	3/8"	1/4"	2"
5224A49500	7/8"	3/16"	1/2"	1/4"	2"
5224A49504	1"	1/4"	1/2"	1/4"	2"
5224A49506	1"	1/4"	1/2"	1/2"	2 7/16"
5224A49512	1 1/4"	3/8"	5/8"	1/4"	2 3/16"
5224A49514	1 1/4"	3/8"	5/8"	1/2"	2 9/16"
5224A49516	1 1/2"	1/2"	3/4"	1/4"	2 1/4"
5224A49519	1 3/4"	5/8"	7/8"	1/2"	2 3/4"
5224A49520	2"	3/4"	1"	1/2"	2 7/8"
5224A49522	2 1/2"	1"	1 1/4"	1/2"	3 3/16"
5224A49526	3 1/2"	1 1/2"	1 3/4"	1/2"	3 5/8"

### Dovetail Bits

Sold Individually



Part Number	Angle	Cutting Diameter Inches	Cutting Length Inches	Shank Diameter Inches	Overall Length Inches
5224A45804	14°	1/2"	1/2"	1/4"	1 3/4"
5224A45806	14°	.532"	1/2"	1/4"	2 1/2"
5224A45832	14°	1/2"	1/2"	1/4"	2"
5224A45838	7°	17/32"	25/32"	1/2"	2 3/16"





## Chamfer Bits 2 Flute With Ball Bearing Guide

Sold Individually



Part Number	Angle	Cutting Diameter Inches	Carbide Length Inches	Shank Diameter Inches	Overall Length Inches
5224A49400	45°	1 1/4"	5/8"	1/4"	2"
5224A49402	45°	1 1/4"	5/8"	1/2"	2 3/8"
5224A49404	45°	1 31/32"	1 1/16"	1/2"	2 23/32"
5224A49406	45°	2 3/8"	1 3/8"	1/2"	2 7/8"
5224A49408	15°	7/8"	21/32"	1/4"	2 1/4"
5224A49410	22 1/2°	1 1/4"	7/8"	1/2"	2 7/8"

## Beading Router Bit

Sold Individually



Part Number	Radius Inches	Large Diameter Inches	Cutting Length Inches	Shank Diameter Inches	Overall Length Inches
5224A56178	5/16"	1 1/8"	9/16"	1/2"	2 3/4"

## Steel Ball Bearing Guides

Sold Individually



Part Number	Inside Diameter Inches	Outside Diameter Inches
5224A47706	3/16"	1/2"
5224A47708	5/16"	7/8"
5224A47738	1/2"	1 1/8"

## Countersinks

82 Degree Angle.  
Overall Length of 7/8".



Part Number	Tool Number	Taper Point Drill Size	Recommended Screw Size	Cutting Diameter
52222408	C5	1/8	#5	3/8"
52222409	C6	9/64	#6	3/8"
52222410	C7	5/32	#7	3/8"
52222411	C8	11/64	#8	3/8"
52222412	C9	3/16	#9	3/8"

## Countersinks

Countersinks mounted on 1/4" Hex Shank.  
Taper Point Drill with Stop Collar.



Part Number	Type	Cutting Diameter	Drill Hole Size
52222408HM	C5HM	3/8	1/8
52222409HM	C6HM	3/8	9/64
52222410HM	C7HM	3/8	5/32
52222411HM	C8HM	3/8	11/64
52222412HM	C9HM	3/8	3/16

Bits &  
Blades

## Regular Taper Point Drill Bits for Countersinks



Part Number	Drill Diameter	Wood Screw Size	Flute Length	Overall Length
517820100125	1/8"	5	1 5/8"	2 3/4"
517820100140	9/64"	6	1 3/4"	2 7/8"
517820100171	11/64"	8	2 1/8"	3 1/4"
517820100187	3/16"	9	2 5/16"	3 1/2"

## Hex Taper Point Drill Bits for Countersinks



Part Number	Drill Diameter	Wood Screw Size	Flute Length	Overall Length	Flute Type
517820140125	1/8"	5	1 5/8"	3 1/2"	1/4 Hex
517820140140	9/64"	6	1 3/4"	3 5/8"	1/4 Hex
517820120187	3/16"	9	2 5/16"	4 1/4"	1/4 Hex
517820140218	7/32"	10	2 7/16"	4 3/8"	1/4 Hex



## Counterbore for Face Frame Machines



Carbide tipped counterbore for Evans, Ritter, Unique, Marcon and Norfield face frame machines and drill presses.

Part Number	Cutting Diameter Inches	Shank Diameter Inches	Overall Length Inches
5224A424000	.136"	3/8"	4 1/2"

## Bi-Metal Hole Saws - Amana Tool



Part Number	Arbor	Drill Hole Size - Inches	Drill Hole Size - MM
5224A602112	3/8"	1"	25mm
5224A602130	7/16"	1 9/16"	40mm
5224A602140	7/16"	2"	51mm
5224A602150	7/16"	2 3/8"	60mm
5224A602152	7/16"	2 1/2"	64mm
5224A602162	7/16"	3"	76mm
5224A602164	7/16"	3 1/8"	79mm
5224A602166	7/16"	3 1/4"	83mm

Bits & Blades

## Arbors for Hole Saws - Amana Tool



Part Number	Arbor	Chuck	Fits Hole Saw Size
5224A602330	3/8"	3/8"	9/16" - 1 3/16"
5224A602332	7/16"	1/2"	1 1/4" - 6"
5224A602338	7/16"	3/8"	1 1/4" - 6"

## Blades

### Utility Knives



Quickchange 2 per Pack  
Part Number: 521903QC

### Replacement Utility Blades



Packed 100 per Box  
Part Number: 521901



Packed 100 per Box  
With Dispenser, Part Number: 521901D

### Razor Blades



Packed 200 per Box  
Part Number: 521902

## Sawzall Blades



Part Number	To Cut	Teeth Per Inch	Width	Length	Box Quantity
5211P78401	Wood	6	3/4"	6"	5
5211P78411	Metal	18	5/8"	4"	5
5211P78412	Metal	18	5/8"	6"	5

## Hacksaw Blades



Part Number	To Cut	Teeth Per Inch	Width	Length	Box Quantity
52131224	3/32" - 1/8"	24	1/2"	12"	10





## Saw Blades - Amana Tool



Part Number	Type	Diameter	# of Teeth	Kerf	Bore	Box Quantity
5214A215240	Ripping	8 - 8 1/4"	24	.087"	5/8"	1
5214AMA8560	Fine Cut	8 1/2"	60	.087"	5/8"	1
5214AMA10024	Ripping	10"	24	.098"	5/8"	1
5214AMA10042	General Purpose	10"	42	.098"	5/8"	1
5214AMA10050	Combination	10"	50	.098"	5/8"	1
5214AMA10060	Compound Miter	10"	60	.098"	5/8"	1
5214A250801	Non-Ferrous/Laminate Flooring	10"	80	.098"	5/8"	1
5214A300400	General Purpose	12"	45	.110"	1"	1
5214A300800	Compound Miter	12"	72	.110"	1"	1

## Jigsaw Blades



Universal Shank

Part Number	To Cut	Teeth Per Inch	Width	Length	Thickness	Box Quantity
5212PT44754	Wood	10	5/16"	4"	0.032	5
5212PT44325	Wood	13	7/32"	3 1/8"	0.049	5

## Jigsaw Blades



Part Number	To Cut	Teeth Per Inch	Material	Length	Brand	Box Quantity
5212BT101AO	Wood	20	HCS	3"	Bosch	5
5212PT44734	Metal	24	Bi-Metal	3"	Generic	5
5212PT123X	Metal	10-24	HSS	4"	Bosch	5
5212PT44743	Wood	8	HCS	4"	Generic	5
5212PT234X	Wood	8-12	HCS	4 1/2"	Bosch	5
5212PT44744	Wood	10	HCS	4"	Generic	5
5212BT101B	Wood	10	HCS	4"	Bosch	5
5212BT101BR	Wood Reverse Tooth	10	HCS	4"	Bosch	5
5212DI8078	Laminate	10	HCS	4"	Generic	5

## Bandsaw Blades



Bits & Blades

Part Number	Tooth Type	Teeth Per Inch	Width	Length	Box Quantity
5218S1264514RC	Raker	14	1/2"	64 1/2"	1
5218S12826HC	Hook	6	1/2"	82"	1
5218S129356HC	Hook	6	1/2"	93 1/2"	1
5218S129454HC	Hook	4	1/2"	94 1/2"	1
5218S141154HC	Hook	4	1/4"	115"	1
5218S38826HC	Hook	6	3/8"	82"	1
5218S389356HC	Hook	6	3/8"	93 1/2"	1



## Taper Taps



Part Number	Size	# of Flutes	Thread Length	Overall Length
52310832T	8-32	4	3/4"	2 1/8"
52311024T	10-24	4	7/8"	2 3/8"
52311032T	10-32	4	7/8"	2 3/8"
52311420T	1/4-20	4	1"	2 1/2"
52313816T	3/8-16	4	1 1/4"	2 15/16"
52311213T	1/2-13	4	1 21/32"	3 3/8"

## Slotted 1/4" Hex Insert Bits



Part Number	Screw Size	Length Inches	Blade Thickness	Blade Width
51214453	#8 - #10	1"	0.042	1/4"

## Phillips Hex Insert Bits



ACR - Ribbed Tip #446 - Reduced

Part Number	Shank Size	Point Size	Length Inches	Length MM
51014401	1/4"	1	1"	25
51014402	1/4"	2	1"	25
51014402ACR	1/4"	2	1"	25
51014403	1/4"	3	1"	25
51014462	1/4"	2	1"	25
51014462ACR	1/4"	2	1"	25

## Socket 1/4" Hex Insert Bits



Part Number	Hex Size	Length Inches	Length MM
5155AM4MM	4mm	2"	50
5155AM5MM	5mm	2"	50
5155AM6MM	6mm	2"	50

## Phillips Threaded Bit



Part Number	Diameter	Length Inches	Length MM
510716ZP	10-32	1 1/2"	38

## Square 1/4" Hex Insert Bits



Part Number	Point Size	Nominal Size	Length Inches	Length MM
51119501	1	3/32"	1"	25mm
51119502	2	1/8"	1"	25mm
51119503	3	9/64"	1"	25mm

## Pozi Drive Bits



Part Number	Type	Point Size	Length Inches	Length MM
51334402PZD	1/4" Insert	2	1"	25
5134492CPZD	1/4" Power	2	6"	152
5134403PZD	1/4" Insert	3	1"	25

## Torx Security 1/4" Hex Insert Bits



Part Number	Driver Size	Length Inches	Length MM
5154TXP10	T10-H	1"	25mm
5154TXP20	T20-H	1"	25mm

\*Ask about our new Impact Magnetized Bits Available on some styles and sizes.

## Torx 1/4" Hex Insert Bits



Part Number	Driver Size	Length Inches	Length MM
513644TX06	T-6	1"	25mm
513644TX07	T-7	1"	25mm
513644TX08	T-8	1"	25mm
513644TX09	T-9	1"	25mm
GRK86417	T-10	1"	25mm
GRK86425	T-15	1"	25mm
513644TX20	T-20	1"	25mm
GRK86441	T-25	1"	25mm
GRK86449	T-30	1"	25mm
GRK86457	T-40	1"	25mm

## Square 1/4" Power Bits



Part Number	Point Size	Nominal Size	Length Inches	Length MM
5112954A0	0	1/16"	3"	75mm
51129541	1	3/32"	2"	50mm
5112954A1	1	3/32"	2 3/4"	75mm
5112954B1	1	3/32"	3 1/2"	100mm
5112954C1	1	3/32"	6"	152mm
5112954A2	2	1/8"	2 3/4"	75mm
5112954B2	2	1/8"	3 1/2"	100mm
5112954C2	2	1/8"	6"	152mm
51129543	3	9/64"	2"	50mm
5112954A3	3	9/64"	2 3/4"	75mm
5112954B3	3	9/64"	3 1/2"	100mm
5112954C3	3	9/64"	6"	152mm

## Phillips 1/4" Power Bits



Part Number	Point Size	Length Inches	Length MM	Body Diameter Inches	Body Diameter MM
5104491	1	1 15/16"	49mm	3/16"	4.8mm
5104491B	1	3 1/2"	89mm	3/16"	4.8mm
5104491C	1	6"	152mm	3/16"	4.8mm
5104492	2	1 15/16"	49mm	1/4"	6.4mm
5104492A	2	2 3/4"	70mm	1/4"	6.4mm
5104492B	2	3 1/2"	89mm	1/4"	6.4mm
5104492C	2	6"	152mm	1/4"	6.4mm
5104493	3	1 15/16"	49mm	5/16"	7.9mm
5104493A	3	2 3/4"	70mm	5/16"	7.9mm
5104493B	3	3 1/2"	89mm	5/16"	7.9mm
5104493C	3	6"	152mm	5/16"	7.9mm

## 2 Piece Square Bits



Part Number	Point Size	Nominal Size	Length Inches	Length MM
51119502P	2	1/8"	1"	25mm
51129542P	2	1/8"	2"	50mm
5112954A2P	2	1/8"	3"	75mm
5112954C2P	2	1/8"	6"	152mm
5112954C3P	3	9/64"	6"	152mm

Bits & Blades

## 6 Point Sockets



Part Number	Square Drive	Hex Opening	Length
5142MX1108	1/4"	1/4"	7/8"
5142M1P10	1/4"	5/16"	7/8"
5142M1P12	1/4"	3/8"	1"
5142M3112	3/8"	3/8"	1 1/4"
5142M3116	3/8"	1/2"	1 1/2"
5142M3118	3/8"	9/16"	1 1/2"
5142M5E16	1/2"	1/2"	1 1/2"

## 1/4" Magnetic Bit Holders



Part Number	Nose Diameter	Length Inches	Length MM
5151M490	7/16"	3"	75mm
5151M490S	3/8"	3"	75mm
5151M4902	7/16"	2"	51mm
5151M4902M*	7/16"	2 1/2"	63mm
5151M4906	3/8"	6"	152mm

\*Super Magnetic

## Hanger Bolt Drivers



Part Number	Broached Hex	Nose Diameter	Length Inches
5141MDA08T	1/4"	7/16"	1 3/4"
5141MDA10T	5/16"	1/2"	1 3/4"
5141MDA12T	3/8"	9/16"	1 3/4"

## Extensions for Sockets



Part Number	Hex Drive	Type of Lock	Length Inches	Length MM
5144EX2502	1/4"	Pin	2"	51mm
5144EX2504	1/4"	Pin	4"	102mm
5144EX3703	3/8"	Pin	3"	76mm

## 1/4" Magnetic Nutsetters



Part Number	Size Inches	Length Inches	Socket Nose
5141MDA08	1/4"	1 3/4"	7/16"
5141MDA10	5/16"	1 3/4"	1/2"
5141MDA12	3/8"	1 3/4"	9/16"
5141MDA14	7/16"	1 3/4"	5/8"
5141MDB08	1/4"	2 9/16"	7/16"
5141MDB10	5/16"	2 9/16"	1/2"
5141MDC08	1/4"	4"	7/16"
5141MDC10	5/16"	4"	1/2"
5141MDC12	3/8"	4"	9/16"
5141MDD08	1/4"	6"	7/16"
5141MDD10	5/16"	6"	1/2"

## Hex Keys

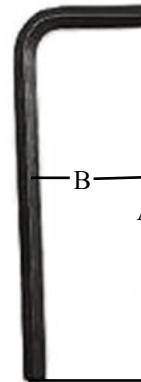

## Fractional Hex Keys

Part Number	Wrench Size	Long Arm (A)	Short Arm (B)
5157025	5/64"	2"	0.656"
515703L	3/32"	3.375"	0.656"
515705	5/32"	2.5"	0.844"
515710	3/16"	2.75"	0.938"

## Metric Hex Keys

Part Number	Wrench Size MM	Long Arm (A)	Short Arm (B)
51574MM	4mm	60mm	20mm
51575MM	5mm	65mm	25mm

## Jobber Bits - General Purpose Fractional

Black Finish, Surface Treated, 118 Degree High Speed Steel  
12 per - 1/64" to 9/32"  
6 per - 19/64" to 1/2"



Drill Size	Part Number	Flute Length	Overall Length
1/16"	516104	7/8"	1 7/8"
5/64"	516105	1"	2"
3/32"	516106	1 1/4"	2 1/4"
7/64"	516107	1 1/2"	2 5/8"
1/8"	516108	1 5/8"	2 3/4"
9/64"	516109	1 3/4"	2 7/8"
5/32"	516110	2"	3 1/8"
11/64"	516111	2 1/8"	3 1/4"
3/16"	516112	2 5/16"	3 1/2"
13/64"	516113	2 7/16"	3 5/8"
7/32"	516114	2 1/2"	3 3/4"
15/64"	516115	2 5/8"	3 7/8"
1/4"	516116	2 3/4"	4"
17/64"	516117	2 7/8"	4 1/8"

Bits & Blades

## Jobber Bits - General Purpose Fractional



Drill Size	Part Number	Flute Length	Overall Length
9/32"	516118	2 15/16"	4 1/4"
5/16"	516120	3 3/16"	4 1/2"
21/64"	516121	3 5/16"	4 5/8"
11/32"	516122	3 7/16"	4 3/4"
23/64"	516123	3 1/2"	4 7/8"
3/8"	516124	3 5/8"	5"
13/32"	516126	3 7/8"	5 1/4"
27/64"	516127	3 15/16"	5 3/8"
7/16"	516128	4 1/16"	5 1/2"
15/32"	516130	4 5/16"	5 3/4"
1/2"	516132	4 1/2"	6"

## Jobber Bits - General Purpose Numerical

Black Finish, Surface Treated, 118 Degree,  
High Speed Steel.  
12 per Box - #1 to #72



Drill Size	Part Number	Diameter	Flute Length	Overall Length
#12	517112	0.189	2 5/16"	3 1/2"
#13	517113	0.185	2 5/16"	3 1/2"
#14	517114	0.182	2 3/16"	3 3/8"
#15	517115	0.180	2 3/16"	3 3/8"
#16	517116	0.177	2 3/16"	3 3/8"
#19	517119	0.166	2 1/8"	3 1/4"
#21	517121	0.159	2 1/8"	3 1/4"
#24	517124	0.152	2"	3 1/8"
#25	517125	0.1495	1 7/8"	3"
#30	517130	0.1285	1 5/8"	2 3/4"
#32	517132	0.116	1 5/8"	2 3/4"
#33	517133	0.113	1 1/2"	2 5/8"
#34	517134	0.111	1 1/2"	2 5/8"
#37	517137	0.104	1 7/16"	2 1/2"
#38	517138	0.1015	1 7/16"	2 1/2"
#39	517139	0.0995	1 3/8"	2 3/8"
#40	517140	0.098	1 3/8"	2 3/8"
#45	517145	0.082	1 1/8"	2 1/8"
#53	517153	0.0595	7/8"	1 7/8"
#72	517172	0.025	5/16"	1 1/8"

## Jobber Bits - Black & Gold

135 Degree Split Point  
Black & Gold, Surface Treated, High Speed Steel.  
12 per Box



Drill Size	Part Number	Flute Length	Overall Length
1/8"	516108135	1 5/8"	2 3/4"
5/32"	516110135	2"	3 1/8"
3/16"	516112135	2 5/16"	3 1/2"
7/32"	516114135	2 1/2"	3 3/4"
1/4"	516116135	2 3/4"	4"
5/16"	516120135	3 3/16"	4 1/2"
3/8"	516124135	3 5/8"	5"
27/64"	516127135	3 15/16"	5 3/8"
7/16"	516128135	4 1/16"	5 1/2"
1/2"	516132135	4 1/2"	6"
V	5181V135	3 5/8"	5"
W	5181W135	3 3/4"	5 1/8"
#10	517110135	2 7/16"	3 5/8"

## Jobber Bits - Black & Gold

135 Degree Split Point  
Black & Gold, Surface Treated, High Speed Steel.  
Sold Individually.

Bits &  
Blades



Drill Size	Part Number	Shank	Flute Length	Overall Length
9/16"	51653612S135	1/2" x 2 1/4"	3"	6"
5/8"	51654012S135	1/2" x 2 1/4"	3"	6"

## Aircraft Extension Bits

Black Finish, Surface Treated, 118 Degree,  
High Speed Steel.  
6 per Box



Drill Size	Part Number	Flute Length	Overall Length
1/8"	51610840	1 5/8"	6"
5/32"	51611040	2"	6"
3/16"	51611240	2 5/16"	6"
7/32"	51611440	2 1/2"	6"
1/4"	51611640	2 3/4"	6"
17/64"	51611740	2 7/8"	6"
5/16"	51612040	3 3/16"	6"

## Cobalt Jobber Bits

Surface Treated, 135 Degree, Split Point,  
Rockwell Hardness.

12 per Box - 1/16" to 1/4"

6 per Box - 17/64" to 1/2"



Drill Size	Part Number	Flute Length	Overall Length
5/64"	516605	1"	2"
3/32"	516606	1 1/4"	2 1/4"
7/64"	516607	1 1/2"	2 5/8"
1/8"	516608	1 5/8"	2 3/4"
9/64"	516609	1 3/4"	2 7/8"
5/32"	516610	2"	3 1/8"
3/16"	516612	2 5/16"	3 1/2"
13/64"	516613	2 7/16"	3 5/8"
7/32"	516614	2 1/2"	3 3/4"
1/4"	516616	2 3/4"	4"
5/16"	516620	3 3/16"	4 1/2"
3/8"	516624	3 5/8"	5"
7/16"	516628	4 1/16"	5 1/2"

## Metric Bits Jobber Length

Bright Finish, 118 Degree, High Speed Steel.

12 per Box - 3mm to 6mm

6 per Box - 8mm to 10mm



Drill Size	Part Number	Flute Length	Overall Length
5mm	519105	62mm	92mm
6mm	519106	70mm	102mm
8mm	519108	81mm	114mm

## Double End Drill Bits

Black Finish, Surface Treated, 135 Degree,  
Split Point.

12 per Box - All Sizes



Drill Size	Part Number	Flute Length	Overall Length
7/64"	516307	1/2"	1 7/8"
1/8"	516308	1/2"	2"
9/64"	516309	1/2"	2"
5/32"	516310	1/2"	2 1/16"
3/16"	516312	1/2"	2 3/16"
7/32"	516314	1/2"	2 3/8"
#20	517320	1/2"	2 1/8"
#30	517330	1/2"	2"

## Stubby/Screw Machine Bits

Black Finish, Surface Treated, 135 Degree,  
Split Point, High Speed Steel.

12 per Box - 1/16" to 9/32"

6 per Box - 5/16" to 1/2"

\*Denotes 118 Degree Split Point



Drill Size	Part Number	Flute Length	Overall Length
*1/16"	516204	5/8"	1 5/8"
*5/64"	516205	11/16"	1 11/16"
3/32"	516206	3/4"	1 3/4"
7/64"	516207	13/16"	1 13/16"
1/8"	516208	7/8"	1 7/8"
9/64"	516209	15/16"	1 15/16"
5/32"	516210	1"	2 1/16"
11/64"	516211	1 1/16"	2 1/8"
7/32"	516214	1 1/4"	2 3/8"
1/4"	516216	1 3/8"	2 1/2"
17/64"	516217	1 7/16"	2 5/8"
5/16"	516220	1 5/8"	2 13/16"
21/64"	516221	1 11/16"	2 7/8"
11/32"	516222	1 11/16"	3"
#29	517229	15/16"	1 7/8"
#38	517238	15/16"	1 13/16"

Bits &  
Blades

## Masonry Drills

Slow Spiral Flutes - Sold Individually



Drill Size	Part Number	Shank Diameter	Overall Length
1/8"	51680832	1/8"	3"
3/16"	51681232	3/16"	4"
3/16"	51681240	3/16"	6"
1/4"	51681632	1/4"	4"
1/4"	51681640	1/4"	6"
5/16"	51682032	1/4"	4"
5/16"	51682040	1/4"	6"
3/8"	51682432	1/4"	4"
3/8"	51682440	3/8"	6"
1/2"	51683232	1/4"	4"
1/2"	51683240	3/8"	6"
5/8"	51684040	1/2"	6"

\* Some Sizes Available in SDS Shank, please contact us  
for more information



## Drill Bits For Concrete Screws

Sold Individually



Drill Size	Part Number	Flute Length	Overall Length
5/32"	51701034	3 1/4"	4 1/2"
3/16"	51701234	3 1/4"	4 1/2"
3/16"	51701238	4 1/4"	5 1/2"

## Replacement Jobbers for Vix Bits

Sold Individually



Drill Size	Part Number
5/64"	518005RVJ
7/64"	518007RVJ
9/64"	518009RVJ
11/64"	518011VBJ

## Brad Point Machine Drills

Sold Individually.



Drill Size	Part Number	Flute Length	Overall Length
1/8"	517508BP	3"	5"
3/16"	517512BP	3"	5"
5mm	51755MMBP	3"	5"
1/4"	517516BP	3"	5"
9/32"	517518BP	3"	5"
5/16"	517520BP	3"	5"
3/8"	517524BP	3"	5"

## Boring Bits

Sold Individually  
Shank Diameter 10mm



Dowel Point



Dowel Point



Through Point

Bit Diameter	Point	Part Number for Left	Part Number for Right	Overall Length
5mm	Dowel	517605L	517605R	57mm
8mm	Dowel	517608L	517608R	57mm
10mm	Dowel	5224A301010	517610R	57mm
11mm	Dowel		517611R	57mm
20mm	Dowel		5224A203201	57mm
25mm	Dowel		5224A203251	57mm
35mm	Dowel		517635R	57mm
40mm	Dowel		517640R	57mm
5mm	Through	517705TL	517705TR	58mm
5mm	Through	51770577TL	51770577TR	77mm

Bits & Blades

## Step Drill Bit HSS

For use with Conformat Screws  
Sold Individually



Drill Size	Part Number	Useable Length	Overall Length
5mm / 7mm	51960705S	3"	5 3/4"

## Vix Bits

Sold Individually



Screw Size	Part Number	Diameter	Shank Size
#3, #4	518005VB	5/64"	1/4"
#5, #6	518007VB	7/64"	1/4"
#8, #9, #10	518009VB	9/64"	1/4"
#12	518011VB	11/64"	1/4"
#14	518013VB	13/64"	1/4"

## Spade Bits

12 per Box



Drill Size	Part Number
3/8"	517424WS
1/2"	517432WS
5/8"	517440WS
11/16"	517422WS
3/4"	517448WS
13/16"	517452WS
7/8"	517456WS
1"	517464WS
1 1/8"	517472WS
1 1/4"	517480WS
1 1/2"	517496WS

U.S. Industrial Fasteners is a SENCOR<sup>®</sup> dealer. If there is something you are looking for that we do not show please contact us. Some items are subject to quantity minimums.

### Senco Wire Staples



Part Number	Crown	Length	Wire Gauge	M/Box	M/Case
7460A04	3/16"	1/4"	22	10	480
7460C02	3/8"	5/32"	22	60	480
7460C04	3/8"	1/4"	22	35	280
7460C06	3/8"	3/8"	22	50	200
7460C07	3/8"	7/16"	22	40	160
7460C08	3/8"	1/2"	22	35	140
7460D10	3/16"	5/8"	22	23	184
7460F08	1/2"	1/2"	20	15	60
7460G10	3/8"	5/8"	20	5	100
7460K11	1/4"	3/4"	19	10	60
7461L06	1/4"	3/8"	18	10	60
7461L08	1/4"	1/2"	18	10	60
7461L10	1/4"	5/8"	18	5	60
7461L11	1/4"	3/4"	18	5	50
7461L12	1/4"	7/8"	18	5	50
7461L13	1/4"	1"	18	5	40
7461L14	1/4"	1 1/8"	18	5	30
7461L15	1/4"	1 1/4"	18	5	30
7461L17	1/4"	1 1/2"	18	5	30
7460M08	3/8"	1/2"	18	10	60
7460M10	3/8"	5/8"	18	5	45
7460M11	3/8"	3/4"	18	5	40
7460M13	3/8"	1"	18	5	30
7460M15	3/8"	1 1/4"	18	-	10
7462N12	7/16"	7/8"	16	5	25
7462N13	7/16"	1"	16	5	20
7462N15	7/16"	1 1/4"	16	-	10
7462N17	7/16"	1 1/2"	16	-	10
7462N19	7/16"	1 3/4"	16	-	10
7463P08	1"	1/2"	16	-	10
7463P10	1"	5/8"	16	-	10
7463P11	1"	3/4"	16	-	10

Staples & Brads

### Generic "L" Wire Staples



Part Number	Crown	Length	Wire Gauge	M/Box	M/Case
74619010	1/4"	5/8"	18	5	80
74619012	1/4"	3/4"	18	5	80
74619014	1/4"	7/8"	18	5	60
74619016	1/4"	1"	18	5	60
74619017	1/4"	1 1/8"	18	5	40
74619018	1/4"	1 1/4"	18	5	40
74619020	1/4"	1 1/2"	18	5	40

### Carton Staples



Part Number	Size	Brand	Box Quantity
74755161510	5/8"	JK	2,400

### Hammer Staples



Part Number	Size	Type	Box Quantity
7468A1106	A11 x 3/8"	Generic	5,000
7468T5004	T50 - 1/4"	Arrow	1,250
7468T5008	T50 - 1/2"	Arrow	1,250

### Senco Corrugated Staples



Part Number	Crown	Length	M/Box	M/Case
7451X06	1"	3/8"	-	5
7451X08	1"	1/2"	-	4

### Senco Senclamp



Part Number	Crown	Length	Thickness	M/Box	M/Case
7460Y07	7/16"	7/16"	0.020	3	24



## Senco Pins and Brads



Part Number	Head	Length	Wire Gauge	M/Box	M/Case
7471AX13	Medium	1"	18	5	80
7471AX15	Medium	1 1/4"	18	5	60
7471AX17	Medium	1 1/2"	18	5	50
7471AY10	Slight	5/8"	18	5	120
7471AY11	Slight	3/4"	18	5	100
7471AY13	Slight	1"	18	5	80
7471AZ08	None	1/2"	18	5	160
7471AZ11	None	3/4"	18	5	120

## Senco Finish Nails



Part Number	Head	Length	Wire Gauge	M/Box	M/Case
7472DA13	Finish	1"	15	4	20
7472DA15	Finish	1 1/4"	15	4	20
7472DA17	Finish	1 1/2"	15	4	20
7472DA19	Finish	1 3/4"	15	4	16
7472DA21	Finish	2"	15	4	16
7472DA25	Finish	2 1/2"	15	3	12

## Generic Micropins



Part Number	Head	Length	Wire Gauge	M/Box	M/Case
74712306	Micropin	3/8"	23	10	120
74712308	Micropin	1/2"	23	10	120
74712310	Micropin	5/8"	23	10	120
74712312	Micropin	3/4"	23	10	120
74712316	Micropin	1"	23	10	120
74712317	Micropin	1 1/8"	23	10	120
747123175	Micropin	1 3/16"	23	10	120
74712319	Micropin	1 3/8"	23	10	80
74712320	Micropin	1 1/2"	23	10	80
74712322	Micropin	1 3/4"	23	10	80
74712324	Micropin	2"	23	10	80

## Generic Brads



Part Number	Head	Length	Wire Gauge	M/Box	M/Case
74711612	Medium	3/4"	16	2.5	30
74711616	Medium	1"	16	2.5	30
74711618	Medium	1 1/4"	16	2.5	30
74711620	Medium	1 1/2"	16	2.5	30
74711622	Medium	1 3/4"	16	2.5	30
74711624	Medium	2"	16	2.5	30
74711626	Medium	2 1/2"	16	2.5	30
74711806	Medium	3/8"	18	5	100
74711808	Medium	1/2"	18	5	100
74711810	Medium	5/8"	18	5	100
74711812	Medium	3/4"	18	5	100
74711816	Medium	1"	18	5	100
747118175	Medium	1 3/16"	18	5	100
74711818	Medium	1 1/4"	18	5	100
74711819	Medium	1 3/8"	18	5	100
74711820	Medium	1 1/2"	18	5	100
74711821	Medium	1 9/16"	18	5	60
74711822	Medium	1 3/4"	18	5	60
74711824	Medium	2"	18	5	60

Available Senco Tools  
Special Order Only

Staples  
& Brads



SFW10XP Fine Wire Stapler



Available Crown Widths 3/16", 3/8", 1/2"  
5/32"-5/8" Lengths. Capacity 110-185  
Available in 4 different models.

SFW10XP A/D Part Number: 74921D0001N  
SFW10XP C Part Number: 74921D0021N  
SFW10XP F Part Number: 74921D0051N  
SFW10XP G Part Number: 74921D0031N





## Tools - Senco

### SKS Medium Wire Stapler



Available Crown Widths 1/4", 3/8",  
7/16", 7/8"-1 1/2" Lengths.  
Capacity 145-158.  
Available in 2 different models.

SKS L Part Number: 749230020N  
SKS N Part Number: 749230084N

### SLS20XP Medium Wire Stapler



Available Crown Widths 3/16", 1/4", 3/8"  
18 Gauge Staples.  
3/8"-1 1/2" Lengths.  
Capacity 168.  
Available in 3 different models.  
Adjustable depth of drive.

SLS20XP L Part Number: 7492490003N  
SLS20XP K Part Number: 7492490002N  
SLS20XP M Part Number: 7492490007N

### SLP20



18 Gauge Slight Head Brads  
5/8"-1"  
18 Gauge Medium Head Brads  
1"-1 5/8"  
Capacity 110

Part Number: 7492430001N

Staples  
& Brads

### SFN30



15 Gauge. Brad Head finishing nails.  
1"-2", 2d-6d. Smooth.  
Capacity 104.

Part Number: 7492620002N

### Finish Pro 41XP



15 Gauge. Brad head finishing nails.  
1"-2", 4d-8d. Smooth.  
Capacity 100.

Part Number: 74921Z0001N



## Tools - Grex

### 1850



18 Gauge Brad Nailer  
3/8" - 2" Length  
Weight 2.4 lbs.  
Magazine Capacity 100

Part Number: 7491G1850

### 1664



16 Gauge Brad Nailer  
1 1/4" - 2 1/2" Length  
Weight 4.7 lbs.  
Magazine Capacity 100

Part Number: 7491G1664

### 9032



18 Gauge Stapler  
1/4" Crown  
3/8" - 1 1/4" Length  
Weight 2.4 lbs.  
Magazine Capacity 150

Part Number: 7491G

### 9040



18 Gauge Stapler  
1/4" Crown  
1/2" - 1 9/16" Length  
Weight 4.07 lbs.  
Magazine Capacity 150

Part Number: 7491G9040L

### 71AD



22 Gauge Stapler  
3/8" Crown  
3/16" - 5/8" Length  
Weight 2.0 lbs.  
Magazine Capacity 100  
Similar to Senco's C series staplers.

Part Number: 7491G71AD





## Tools - Grex

2564



Concrete T-Nailer  
5/8" - 2 1/2" Length  
Weight 5.7 lbs.  
Magazine Capacity 80

Part Number: 7491G2564

P630



23 Gauge Pinner  
3/8" - 1 3/16" Length  
Weight 2.1 lbs.  
Magazine Capacity 100

Part Number: 7491GP630

P635



23 Gauge Pinner  
3/8" - 1 3/8" Length  
Weight 2.21 lbs.  
Magazine Capacity 100

Part Number: 7491GP635

P650LX



23 Gauge Pinner with Auto Lock-out  
Featuring One Touch Override  
1/2" - 2" Length  
Weight 3.25 lbs.  
Magazine Capacity 100

Part Number: 7491GP650LX



Edge Guides are available, please contact U.S. Industrial Fasteners for more information



## Tools - Grex

### Cordless Pinner

GC1850



Grex 18 Gauge Cordless Pinner  
Includes 2 AAA batteries  
Fuel Cartridges Sold Separately  
1/2" - 2" Length  
Weight 4.55 lbs.  
Magazine Capacity 100

Part Number: 7491GC1850

GCP650



23 Gauge Cordless Pinner  
Includes 2 AAA batteries  
Fuel Cartridges Sold Separately  
(Cartridges shown on previous page)  
3/8" - 2" Length  
Weight 3.75 lbs.  
Magazine Capacity 100

Part Number: 7491GCP650

### Fuel Cartridges



Fuel Cartridges for GCP650  
4 Cartridges per Box

Part Number: 7485GFC0104

Staples  
& Brads

### Gun Oil



The oil reduces the coefficient of friction between moving parts and reduces the amount of heat produced by the motor. Use 2-3 drops per day or as needed to maintain tool performance.  
4 fluid ounces  
12 per case

Part Number: 7495Z4OZ

Repair parts for Senco and Grex Guns are available please contact U.S. Industrial Fasteners for more information



## Phillips Flat Coarse Thread Tapping Screws



Stocked in Steel Zinc Plating.  
Some sizes are available in Antique Brass, Bright Brass and Black Oxide, please call for availability.

Size	Thread Type	Part Number	Weight Pounds/M	Carton Quantity
5 x 1/2	Coarse	01610508xx	1.15	40,000
5 x 5/8	Coarse	01610510xx	1.32	32,000
6 x 1/2	Coarse	01610608xx	1.50	30,000
6 x 1/2	Coarse Type 17	01610608xx17	1.50	30,000
6 x 5/8	Coarse	01610610xx	1.76	20,000
6 x 5/8	Coarse Type 17	01610610xx17	1.76	20,000
6 x 5/8	Coarse Type 17 Under Cut	01610610xx17U	1.76	25,000
6 x 3/4	Coarse	01610612xx	1.95	20,000
6 x 3/4	Coarse Type 17	01610612xx17	1.95	20,000
7 x 5/8	Coarse	0161071002	1.78	20,000
7 x 5/8	Coarse Type 17 Under Cut	016107100217U	1.90	20,000
7 x 3/4	Coarse	0161071202	2.44	20,000
8 x 5/8	Coarse	01610810xx	2.40	14,000
8 x 5/8	Coarse Type 17	01610810xx17	2.40	14,000
8 x 3/4	Coarse	01610812xx	3.50	12,000
8 x 3/4	Coarse Type 17	01610812xx17	3.50	12,000
10 x 3/4	Coarse	01611012xx	4.50	10,000



## Phillips Oval Coarse Thread Tapping Screws



Stocked in Steel Zinc Plating,  
Antique Brass, Bright Brass, and  
Black Oxide.

Size	Thread Type	Part Number	Weight Pounds/M	Carton Quantity
6 x 5/8	Coarse	01630610xx	2.00	22,000

## Phillips Round Washer Head Coarse Thread Tapping Screws



Stocked in Nickel.

Size	Thread Type	Part Number	Weight Pounds/M	Carton Quantity
8 x 3/4	Coarse Type 17	016608120917	3.90	10,000

## Drawer Front Adjuster Screws



Stocked in Steel Zinc Plating.  
Available in Black Oxide.

Size	Thread Type	Part Number	Weight Pounds/M	Carton Quantity
8 x 7/8	Coarse	01670814xx	4.90	10,000
8 x 7/8	Coarse Type 17	01670814xx17	4.90	10,000
8 x 1	Coarse	01670816xx	5.50	8,000
8 x 1	Coarse Type 17	01670816xx17	5.50	8,000
8 x 1 1/8	Coarse	01670817xx	6.50	6,000
8 x 1 1/8	Coarse Type 17	01670817xx17	6.50	6,000
8 x 1 1/4	Coarse	01670818xx	6.64	6,000
8 x 1 1/4	Coarse Type 17	01670818xx17	6.64	6,000
8 x 1 1/2	Coarse Type 17	01670820xx17	6.80	5,000

### Fasteners

## Phillips Pan Coarse Thread Tapping Screws



Stocked in Steel Zinc Plating.  
Some sizes are available in Antique Brass, Bright Brass and Black Oxide, please call for availability.

Size	Thread Type	Part Number	Weight Pounds/M	Carton Quantity
6 x 1/2	Coarse	01620608xx	1.80	21,000
6 x 1/2	Coarse Type 17	01620608xx17	1.80	21,000
6 x 5/8	Coarse	01620610xx	2.20	17,000
6 x 5/8	Coarse Type 17	01620610xx17	2.20	17,000
8 x 5/8	Coarse	01620810xx	3.30	11,000
8 x 5/8	Coarse Type 17	01620810xx17	3.30	11,000
8 x 3/4	Coarse	01620812xx	3.90	9,500
8 x 3/4	Coarse Type 17	01620812xx17	3.90	9,500
8-9 x 3/4	Coarse	01620812xxC	3.90	10,000
8 x 1	Coarse	01620816xx	5.10	6,000
8 x 1	Coarse Type 17	01620816xx17	5.10	6,000
10 x 5/8	Coarse Type 17	01621010xx17	5.00	10,000

## Drawer Slide Screws



Stocked in Steel Zinc Plating.  
Low Profile Head.

Size	Thread Type	Part Number	Weight Pounds/M	Carton Quantity
8 x 7/16	Coarse	01660807xx	2.00	20,000
8 x 1/2	Coarse	01660808xx	2.25	14,000



### Phillips Flat Particle Board Screws



Stocked in Steel - Plain and Lube.  
Some sizes are available in Zinc and Black Oxide, please call for availability.

Size	Thread Type	Part Number	Weight Pounds/M	Carton Quantity
6 x 1	Coarse	06610616xx	2.60	10,000
6 x 1 1/4	Coarse	06610618xx	3.10	10,500
6 x 1 1/2	Coarse	06610620xx	3.70	8,000
8 x 1	Coarse	06610816xx	3.90	10,000
8 x 1 1/4	Coarse	06610818xx	4.50	8,000
8 x 1 1/2	Coarse	06610820xx	5.20	6,000
8 x 1 5/8	Coarse	06610821xx	5.60	5,000
8 x 1 3/4	Coarse	06610822xx	6.00	4,000
8 x 2	Coarse	06610824xx	6.60	3,500
8 x 2 1/4	Coarse	06610825xx	7.70	3,000
8 x 2 1/2	Coarse	06610826xx	8.80	2,500
8 x 3	Coarse	06610828xx	10.50	2,000



### Square Flat Particle Board Screws



Stocked in Steel - Plain and Lube.  
Some sizes are available in Zinc and Black Oxide, please call for availability.

Size	Thread Type	Part Number	Weight Pounds/M	Carton Quantity
6 x 5/8	Coarse	06910610xx	1.90	25,000
6 x 3/4	Coarse Type 17	06810612xx17	1.95	20,000
6 x 1 3/4	Coarse Type 17	06810622xx17N	4.30	5,000
8 x 3/4	Coarse	06810812xx	3.50	15,000
8 x 1 3/8	Coarse with Nibs	06810819xx	4.60	8,000
8 x 1 1/2	Coarse Type 17	06810820xx17N	5.20	7,000
8 x 2 1/2	Coarse	06810826xx	9.60	2,500
10 x 4	Coarse Type 17	06811032xx17N	16.90	1,000

### Phillips Flat Particle Board Screws Type 17 With Nibs



Stocked in Steel Zinc Plating and Black.

Size	Part Number	Weight Pounds/M	Carton Quantity
8 x 1	06610816xx17N	3.90	11,000
8 x 1 1/4	06610818xx17N	4.50	9,000
8 x 1 1/2	06610820xx17N	5.20	7,000
8 x 1 3/4	06610822xx17N	6.00	5,000
8 x 2	06610824xx17N	6.60	4,000
8 x 2 1/4	06610825xx17N	7.70	3,000
8 x 2 1/2	06610826xx17N	8.80	2,500
8 x 3	06610828xx17N	10.50	2,000

### Square Pan Particle Board Screws



Stocked in Steel - Plain and Lube.

Size	Thread Type	Part Number	Weight Pounds/M	Carton Quantity
8 x 1 1/4	Coarse	0682081801	4.50	8,000
8 x 1 3/4	Coarse	0682082201	6.00	4,000
8 x 2	Coarse	0682082401	6.60	3,500

Fasteners

### Square Flat Funnel Screws



Stocked in Steel Zinc Plating.

Size	Thread Type	Part Number	Weight Pounds/M	Carton Quantity
8 x 1 3/8	Type 17 Spiral	068808190217S	5.00	8,000
8 x 1 1/2	Type 17 Spiral	068808200217S	5.40	7,000
8 x 1 5/8	Type 17 Spiral	068808210217S	5.90	6,000
8 x 1 3/4	Type 17 Spiral	068808220217S	6.30	5,000
8 x 2	Type 17 Spiral	068808240217S	7.20	4,000
8 x 2 1/4	Type 17 Spiral	068808250217S	7.90	3,000
8 x 2 1/2	Type 17 Spiral	068808260217S	8.80	2,500

### Cabinet Installation Screws

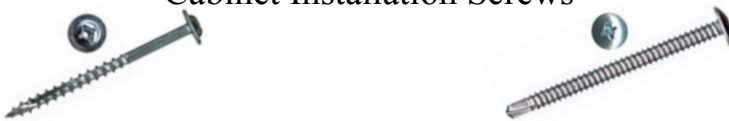

Size	Type	Part Number	Finish	Carton Quantity
10 x 2 1/2	Phillips Truss Tek	0314102608	Black	2,000
10 x 2 1/2	Phillips Truss Tek	0314102621	White	2,000
10 x 2 1/2	Square Round Washer Head Tek	0336102602	Zinc	2,000
10 x 2 1/2	Square/Phillips Round Washer Head Quickcut	069610260217Q	Zinc	1,500
10 x 2 1/2	Square/Phillips Round Washer Head Quickcut	069610262117Q	White	1,500
10 x 3	Square/Phillips Round Washer Head Quickcut	069610280217Q	Zinc	1,500
10 x 3	Square/Phillips Round Washer Head Coarse	069610282117	White	1,500



## Square/Phillips Flat Particle Board Screws Type 17 With Nibs



Stocked in Steel Zinc Plating.  
Some sizes are available in  
Yellow Zinc and Plain, please call  
for availability.

Size	Thread Type	Part Number	Weight Pounds/M	Carton Quantity
8 x 1	Coarse	06910816xx17N	3.60	10,000
8 x 1 1/4	Coarse	06910818xx17N	4.40	9,000
8 x 1 1/2	Coarse	06910820xx17N	4.85	7,000
8 x 1 5/8	Coarse	06910821xx17N	5.82	5,500
8 x 2	Coarse	06910824xx17N	7.00	4,000
8 x 2 1/4	Coarse	06910825xx17N	7.50	3,000
8 x 2 1/2	Coarse	06910826xx17N	8.36	2,500
8 x 3	Coarse	06910828xx17N	11.00	2,000
10 x 3 1/2	Coarse	06911030xx17N	19.60	1,000
10 x 4	Coarse	06811032xx17N	25.80	1,000
10 x 5	Quickcut	06911036xx17Q	40.00	500



## Phillips Pan Face Frame Screws Type 17



Stocked in Steel Black Oxide.

Size	Thread Type	Part Number	Weight Pounds/M	Carton Quantity
6 x 1 1/4	Type 17	041206180817	4.40	8,000
6 x 1 1/2	Type 17 2/3 Thread	04120620081723	4.90	7,000

## Square Pan Face Frame Screws Type 17



Stocked in Steel Plain and Lube.

Size	Thread Type	Part Number	Weight Pounds/M	Carton Quantity
7 x 1	Coarse Type 17	04820616xx17	3.99	5,000
6 x 1 1/4	Type 17	04320618xx17	4.40	8,000
6 x 1 1/4	Quickcut	04320618xx17Q	4.40	8,000
7 x 1 1/4	Hilo Type 17	04320618xx17HL	4.40	8,000
7 x 1 1/4	Coarse Type 17	04820618xx17	5.10	7,000
6 x 1 1/2	Type 17	04320620xx17	4.40	8,000
6 x 1 1/2	Quickcut	04320620xx17Q	4.40	7,000
7 x 1 1/4	Coarse Type 17 Long	048207180117L	4.40	7,500
7 x 1 1/2	Coarse Type 17	04820620xx17	5.10	7,000
7 x 1 1/2	Coarse Type 17 Long	048207200117L	5.10	6,000

## Square/Phillips Round Washer Head Particle Board Screws



Stocked in Steel - Plain and Lube.  
Some sizes are available in Zinc and  
Black Oxide, please call for  
availability.

Fasteners

Size	Thread Type	Part Number	Weight Pounds/M	Carton Quantity
8 x 3/4	Coarse Type 17	06960812xx17	5.10	8,000
8 x 1	Coarse	06860816xx	5.10	8,000
8 x 1 1/4	Coarse	06860818xx	6.00	6,000
8 x 1 1/2	Coarse	06860820xx	7.00	5,000
8 x 2	Coarse	06860824xx	8.70	3,000
8 x 2 1/2	Coarse	06860826xx	11.40	1,500
8 x 3	Coarse	06860828xx	12.80	1,500
8 x 3 1/2	Coarse	06860830xx	14.20	1,000
10 x 2 1/2	Quickcut	06961026xx17Q	11.37	1,500
10 x 3	Quickcut	06961028xx17Q	13.38	1,500
10 x 4	Coarse Type 17	06861032xx17	19.20	1,000
10 x 4 1/2	Coarse	06861034xx	20.53	1,000

## Phillips Bugle Coarse Thread Drywall Screws



Stocked in Steel Black Oxide and  
Yellow Zinc.

Size	Thread Type	Part Number	Weight Pounds/M	Carton Quantity
6 x 3/4	Coarse	04610612xx	2.50	15,000
6 x 1	Coarse	04610616xx	3.10	10,000
6 x 1 1/8	Coarse	04610617xx	3.50	10,000
6 x 1 1/4	Coarse	04610618xx	3.75	8,000
6 x 1 1/2	Coarse	04610620xx	4.20	6,000
6 x 1 5/8	Coarse	04610621xx	4.80	5,000
6 x 1 3/4	Coarse	04610622xx	5.00	4,000
6 x 2	Coarse	04610624xx	5.70	3,500
6 x 2 1/4	Coarse	04610625xx	7.30	3,000
8 x 2 1/2	Coarse	04610826xx	9.60	2,500
8 x 3	Coarse	04610828xx	11.50	2,000
10 x 4	Coarse	04611032xx	20.00	1,000
10 x 6	Coarse	04611040xx	34.00	500



## Draw Bolts



Stocked in Steel Zinc plating.

Size	Part Number	Weight Pounds/M	Carton Quantity
1/4-20 x 3 1/2	2500143002	170.00	500
6m x 65m	64177850016065	120.00	100

## Pan Head Euro Screws



Stocked in Steel Zinc plating.

Size	Part Number	Weight Pounds/M	Carton Quantity
6mm x 10mm	3702061002	3.00	6,000
6mm x 13mm with Shoulder	65V236X144	4.50	5,000
6mm x 16mm	3702061602	6.75	1,000

## Euro Screws



Stocked in Steel Nickel Plating.

Size	Part Number	Drive	Weight Pounds/M	Carton Quantity
6.3mm x 10.5mm	3701051002	Pozi	3.00	10,000
6.3mm x 13mm	3701051309	Pozi	4.00	10,000
6.3mm x 13mm	3701051302G	Phillips	4.00	10,000
6.3mm x 18mm	3701051802	Pozi	4.50	5,000
6.3mm x 25mm	3701052502	Pozi	8.50	2,500
6.3mm x 30mm	3701053002	Pozi	9.50	2,500

Note: Use 5mm Drill

## Torq Flat Screws



Stocked in Steel Yellow Plating.

Size	Part Number	Weight Pounds/M	Carton Quantity
4 x 3/8	GRK02021	.92	100
4 x 5/8	GRK02025	1.28	100
4 x 1	GRK02029	1.85	100
6 x 1/2	GRK02043	1.54	100
6 x 1	GRK02049	2.60	100
6 x 1 3/4	GRK02057	4.27	100
6 x 2	GRK02059	4.88	100
8 x 3/4	GRK02065	2.91	100
8 x 1 1/2	GRK00073	5.03	6,500
8 x 1 3/4	GRK00075	5.59	6,000
8 x 2 1/2	GRK00079	7.35	3,500
8 x 2 3/4	GRK02081	8.47	100

## Torq Flat Screws



Size	Part Number	Weight Pounds/M	Carton Quantity
9 x 1	GRK02089	4.00	100
9 x 1 1/4	GRK00091	4.48	8,000
9 x 1 1/2	GRK00095	5.99	5,200
9 x 1 3/4	GRK00097	6.62	4,500
9 x 2	GRK02099	7.75	100
9 x 2	GRK00099	7.75	3,700
9 x 2 1/2	GRK01101	9.01	575
9 x 2 3/4	GRK02103	10.00	100
9 x 2 3/4	GRK01103	10.00	480
9 x 2 3/4	GRK00103	10.00	2,000
9 x 3 1/8	GRK02105	11.49	100
9 x 3 1/8	GRK01105	11.49	425
9 x 3 1/8	GRK00105	11.49	1,900
10 x 2	GRK02131	9.01	100
10 x 2 1/2	GRK02133	10.99	100
10 x 3 1/2	GRK02139	15.15	50
10 x 3 1/2	GRK00139	15.15	1,200
10 x 4	GRK02141	18.18	50
10 x 4	GRK00141	18.18	1,000
10 x 4 3/4	GRK02143	21.74	50
10 x 4 3/4	GRK00143	21.74	800
12 x 5 5/8	GRK00173	37.04	600
12 x 6 3/8	GRK00177	41.67	1,000
12 x 8	GRK02181	52.63	50
12 x 10	GRK02187	66.61	50

## Torq Trim Head Screws



Stocked in Steel Yellow Plating.

Size	Part Number	Weight Pounds/M	Carton Quantity
8 x 1 1/2	GRK15724	4.07	6,500
8 x 2 1/2	GRK16079	6.67	605
8 x 2 1/2	GRK15079	6.67	3,500
8 x 3 1/8	GRK15083	8.93	2,500
9 x 5	GRK15766	17.86	800

Fasteners

## Torq Lag Screws



Stocked in Steel Yellow Plating.

Size	Part Number	Weight Pounds/M	Carton Quantity
8 x 2 1/2	GRK10079	8.20	1,500
10 x 2	GRK12131	10.99	50
10 x 3 1/8	GRK12137	15.87	50
1/4 x 1 1/2	GRK12151	13.16	50
5/16 x 2 3/4	GRK12219	29.41	100
5/16 x 4	GRK12225	40.00	100
5/16 x 5 1/8	GRK12231	50.00	50
5/16 x 6	GRK12235	55.00	50
3/8 x 8	GRK12287	90.91	50
3/8 x 10	GRK12293	111.11	50

## Poly Toggle



Stocked in Plastic.

For Thickness	Part Number	Weight Pounds/M	Carton Quantity
0 - 3/8	440201	4.00	100
3/8 - 1/2	440202	4.40	100
1/2 - 5/8	440203	5.20	100

## Kap Toggle



Stocked in Steel Zinc plating.

Size	Part Number	Weight Pounds/M	Carton Quantity
3/16	44031002	30.00	1,000
1/4	44031402	40.00	1,000

## Torq Bits



Bit Size	Part Number	Color	Box Quantity
T-10 1"	GRK86417	Yellow	50
T-15 1"	GRK86425	Red	50
T-25 1"	GRK86441	Green	50
T-25 2"	GRK86443	Green	25
T-30 1"	GRK86449	Black	50
T-40 1"	GRK86457	Blue	50

## Auger Anchor



Nylon



Metal

Size	Material	Part Number	Weight Pounds/M	Carton Quantity
6 - 8	Nylon	44040608	5.00	5,000
8 - 10	Nylon	44040810N	5.00	5,000
8 - 10	Steel	44040810	12.50	1,000

Fasteners/  
Anchors

## Toggle Wings



Stocked in Steel Zinc plating.

Size	Part Number	Weight Pounds/M	Carton Quantity
1/8	44010602	6.60	8,000
3/16	44011002	19.00	1,450
1/4	44011402	25.20	800
5/16	44012502	42.00	500
3/8	44012602	55.10	300

## Wall Dog



Size	Part Number	Color	Carton Quantity
1/4 x 1 1/4	44042316	Chrome	5,000
1/4 x 1 1/4	44042331	White	5,000

## Conical Anchors



Stocked in Plastic.

Size	Style	Part Number	Weight Pounds/M	Carton Quantity
6 - 8	Lip	442106	.60	40,000
10 - 12	Lip	442110	1.12	20,000
10 - 12	No Lip	442110N	.92	1,000
14 - 16	Lip	442114	1.75	10,000

## Auger Toggle



Size	Part Number	Carton Quantity
8-32 x 2 1/8"	44040825A	100



## Tubular Anchors

Stocked in Plastic

F - Frame

B - Bulk

Size	Color	Part Number	Weight Pounds/M	Carton Quantity
1-3 x 1	Yellow	44220116F	1.80	500
4-6 x 1 1/2	White	44220420B	1.60	2,000
10-12 x 1	Green	44221016B	2.00	19,000
10-12 x 1 1/4	Green	44221018B	3.40	14,000
10-12 x 1 1/2	Green	44221020B	4.00	12,000
10-12 x 2	Green	44221024F	4.40	250
13-15 x 1	Blue	44221316F	3.60	500
13-15 x 1 1/2	Blue	44221320B	4.60	10,000
16-18 x 1 1/2	Orange	44221620F	8.40	100
16-18 x 2	Orange	44221624F	10.40	100
20-24 x 1 1/2	Gray	44222020F	14.40	200

## Nail-In Anchors



Stocked in Zinc Die Cast/Steel.

Available in Nylon.

Size	Part Number	Weight Pounds/M	Carton Quantity
1/4 x 1	4426141602	20.00	1,000
1/4 x 1 1/4	4426141802	23.50	1,000
1/4 x 1 1/2	4426142002	26.50	1,000
1/4 x 2	4426142402	33.50	1,000

## Sleeve Anchors



Stocked in Steel Zinc plating.

Size	Head Type	Part Number	Weight Pounds/M	Carton Quantity
1/4 x 2	Flat	4442142402F	33.60	100
1/4 x 3	Flat	4442142802F	36.80	100
1/4 x 5 1/4	Flat	4442143702F	53.60	100
5/16 x 5 1/2	Flat	4442252602F	57.60	100
3/8 x 2 3/4	Flat	4442262702F	80.00	100
3/8 x 5	Flat	4442263602F	136.00	100
5/16 x 1 1/2	Hex	4442252002H	40.20	100
3/8 x 1 7/8	Hex	4442262302H	70.40	100
5/8 x 2 1/4	Hex	4442302502H	250.40	100
3/4 x 4	Hex	4442323202H	608.00	100
5/16 x 2 3/8	Round	4442252502R	55.60	100

## Hex Washer Head Concrete Screws with Drill Bit



Stocked in Steel - Coated.

Size	Head Style	Part Number	Weight Pounds/M	Carton Quantity
10 x 1 1/4	HWH	4408011018	8.40	100
10 x 1 3/4	HWH	4408011022	12.00	100
10 x 2 1/4	HWH	4408011025	15.20	100
10 x 2 3/4	HWH	4408011027	16.00	100
10 x 3 1/4	HWH	4408011029	19.60	100
10 x 3 3/4	HWH	4408011031	21.80	100
14 x 1 1/4	HWH	4408011418	14.00	100
14 x 1 3/4	HWH	4408011422	17.40	100
14 x 2 1/4	HWH	4408011425	22.00	100
14 x 2 3/4	HWH	4408011427	26.00	100
14 x 3 1/4	HWH	4408011429	31.80	100
14 x 3 3/4	HWH	4408011431	36.80	100
14 x 4	HWH	4408011432	38.00	100

## Wedge Anchors



Stocked in Steel Zinc plating.

**Anchors**

Size	Part Number	Weight Pounds/M	Carton Quantity
1/4 x 2 1/4	4441142502I	39.20	100
1/4 x 3 1/4	4441142902I	60.00	100
3/8 x 2 1/4	4441262502I	89.00	100
3/8 x 2 3/4	4441262702I	105.00	100
3/8 x 3	4441262802I	113.60	100
3/8 x 3 3/4	4441263102I	133.80	100
1/2 x 5 1/2	4441283802I	324.80	25
5/8 x 4 1/2	4441303402	470.40	25
3/4 x 4 1/4	4441323302	652.00	20
3/4 x 5 1/2	4441323802	784.00	20
3/4 x 6 1/4	4441324102	906.00	10
3/4 x 7	4441324402	980.00	10
3/4 x 10	4441325602	1388.00	10

## Phillips Flat Head Concrete Screws with Drill Bit



Stocked in Steel - Coated.

Size	Head Style	Part Number	Weight Pounds/M	Carton Quantity
10 x 1 1/4	Phil Flat	4408111018	8.40	100
10 x 1 3/4	Phil Flat	4408111022	12.00	100
10 x 2 1/4	Phil Flat	4408111025	13.60	100
10 x 2 3/4	Phil Flat	4408111027	16.00	100
10 x 3 1/4	Phil Flat	4408111029	19.60	100
10 x 3 3/4	Phil Flat	4408111031	21.00	100
10 x 4	Phil Flat	4408111032	21.80	100
14 x 1 1/4	Phil Flat	4408111418	13.60	100
14 x 1 3/4	Phil Flat	4408111422	17.40	100
14 x 2 1/4	Phil Flat	4408111425	22.00	100
14 x 2 3/4	Phil Flat	4408111427	26.00	100
14 x 3 1/4	Phil Flat	4408111429	29.60	100
14 x 3 3/4	Phil Flat	4408111431	35.00	100
14 x 4	Phil Flat	4408111432	36.00	100



## Power Loads - Powers



Size	Load Type	Part Number	Weight Pounds/M	Carton Quantity
22C Gray	Crimp	446622C1GY	2.00	100
22C Green	Crimp	446622C3G	2.00	100
25C Green	Strip	446725SG	5.00	100
25C Red	Strip	446725SR	5.00	100
27C Red	Strip	446827SR	4.00	100
27C Yellow	Strip	446827SY	4.00	100
27C Green	Crimp	446827C3G	4.00	100

## Pins - Powers



Size	Velocity	Part Number	Weight Pounds/M	Carton Quantity
.300 x 1/2	LV	446108LV	4.00	100
.300 x 3/4	LV	446112LV	6.00	100
.300 x 1	LV	446116LV	7.00	100
.300 x 1 1/2	LV	446120LV	10.00	100
1/4 H x 1 1/4	HV	44621814LV	9.00	100
1/4 H x 1 1/2	HV	44622014LV	11.00	100
1/4 H x 2 1/2	HV	44622614LV	16.00	100
3/8 H x 2	HV	44632624	18.00	100

## Pins With a Washer - Powers



Size	Velocity	Part Number	Weight Pounds/M	Carton Quantity
.300 x 1	LV	446116WLV	16.00	100
.300 x 1 1/4	LV	446118WLV	17.00	100
.300 x 1 1/2	LV	446120WLV	18.00	100
.300 x 2	LV	446124WLV	20.00	100

Other Anchors are available upon request.  
Please contact us for more information.

## Fasteners

U.S. Industrial Fasteners carries a wide variety of fasteners. Please contact us for more information.

### Phillips Pan Framing Drill Screws



Stocked in Zinc.

### Phillips Pan Framing Screws



Stocked in Steel Black Oxide.

### Phillips Bugle Hi/Lo Thread Drywall Screws



Stocked in Steel Black Oxide.

### Phillips Bugle Fine Thread Drywall Screws



Stocked in Steel Black Oxide.  
Available in Yellow Zinc.

### Phillips Bugle Drywall Drill Screws



Stocked in Steel Black Oxide.  
Available in Zinc.

### Phillips Trim Head Screws



Stocked in Steel Black Oxide.

Anchors/  
Fasteners



### Square Trim Head Screws



Stocked in Steel Black Oxide.

### Phillips Truss Tapping Screws



Stocked in Steel Zinc Plating.  
Some sizes are available in 18-8  
Stainless Steel and Black Oxide.

### Square Trim Head Drill Screws



Stocked in Steel Black Oxide.  
Available in Zinc.

### Square Flat Tapping Screws



Stocked in Steel Zinc Plating.  
Some sizes are available in Black  
Oxide.

### Hex Washer Head Tapping Screws



Stocked in Steel Zinc Plating.  
Some sizes are available in 18-8 Stainless  
Steel, Black Zinc and Painted, please call  
for availability.

### Square Pan Tapping Screws



Stocked in Steel Zinc Plating.  
Some sizes are available in  
Black Oxide.

### Hex Washer Head Neo Tapping Screws



Stocked in Steel Zinc Plating.  
Some sizes are available in Painted.

### Square Truss Tapping Screws



Stocked in Steel Zinc Plating.  
Some sizes are available in Black  
Oxide.

### Phillips Flat Tapping Screws



Stocked in Steel Zinc Plating.  
Some sizes are available in 18-8  
Stainless Steel, Antique Brass, Bright  
Brass, Stat Bronze, and Black Oxide.

### Slotted Hex Washer Head Zap Screws



Stocked in Steel Zinc Plating. Some  
sizes are available in Black Oxide.

Fasteners

### Phillips Pan Tapping Screws



Stocked in Steel Zinc Plating.  
Some sizes are available in 18-8  
Stainless Steel, Antique Brass, Bright Brass  
and Black Oxide.

### Phillips Modified Truss Zap Screws



Stocked in Steel Zinc Plating.  
Some sizes are available in Black  
Oxide.

### Phillips Oval Tapping Screws



Stocked in Steel Zinc Plating. Some sizes  
are available in 18-8 Stainless Steel, Antique  
Brass, Bright Brass, and Black Oxide.

### Hex Washer Head Drill Screws



Stocked in Steel Zinc Plating.  
Some sizes are available in 410 Stainless  
Steel, Yellow Zinc and Black Zinc.

### Phillips Flat Drill Screws



Stocked in Steel Zinc Plating. Some sizes are available in 410 Stainless Steel, Yellow Zinc and Black Zinc.

### Phillips Flat Wood Screws



Stocked in Steel Zinc Plating. Some sizes are available in Solid Brass and Plain.

### Phillips Pan Drill Screws



Stocked in Steel Zinc Plating. Some sizes are available in Black Zinc.

### Square Flat Wood Screws



Stocked in Steel - Plain and Lube. Available in Zinc and Black Oxide.

### Phillips Modified Truss Drill Screws



Stocked in Steel Zinc Plating.

### Hex Lag Screws



Stocked in Steel Zinc Plating. Available in 18-8 Stainless Steel, Hot Dipped Galvanized, Plain, and Black Oxide.

### Square Pan Drill Screws



Stocked in Steel Zinc Plating.

### Carriage Bolts



Stocked in Steel Zinc Plating. Available in 18-8 Stainless Steel, Hot Dipped Galvanized, Plain, and Black Oxide.

## Fasteners

### Phillips Oval Drill Screws



Stocked in Steel Zinc Plating.

### Hex Cap Screws Grade 2 NC



Stocked in Steel Zinc Plating. Available in 18-8 Stainless Steel, Hot Dipped Galvanized, Plain, and Full Thread.

### Phillips Oval Sems Drill Screws



Stocked in Steel Zinc Plating.

### Hex Cap Screws Grade 5 NC



Stocked in Steel Zinc Plating. Available in Plain.

### Phillips Wafer Head Drill Screws



Stocked in Steel Zinc Plating.

### Hex Cap Screws Grade 5 NF



Stocked in Steel Zinc Plating. Available in Plain.



### Hex Cap Screws Grade 8 NC



Stocked in Yellow Zinc Plating.  
Available in Plain.

### Flat Head Socket Cap Screws NC



Stocked in Steel - Plain. Available  
in Zinc and Stainless Steel.

### Hex Cap Screws Grade 8 NF



Stocked in Yellow Zinc Plating.  
Available in Plain.

### Flat Head Socket Cap Screws NF



Stocked in Steel - Plain. Available  
in Zinc and Stainless Steel.

### Metric Hex Cap Screws



Stocked in Steel - Plain.  
Available in Zinc.

### Button Head Socket Cap Screws NC



Stocked in Steel - Plain. Available  
in Zinc and Stainless Steel.

### A-325 Structural Bolts



Stocked in Steel - Plain.

### Button Head Socket Cap Screws NF



Stocked in Steel - Plain. Available  
in Zinc and Stainless Steel.

### Hex Socket Cap Screws NC



Stocked in Steel - Plain. Available  
in Zinc and Stainless Steel.

### Socket Set Screws NC Cup Point **Fasteners**



Stocked in Steel - Plain. Available  
in Zinc and Stainless Steel.

### Hex Socket Cap Screws NF



Stocked in Steel - Plain. Available  
in Zinc and Stainless Steel.

### Socket Set Screws NF Cup Point



Stocked in Steel - Plain. Available  
in Zinc and Stainless Steel.

### Metric Hex Socket Cap Screws



Stocked in Steel - Plain. Available  
in Zinc and Stainless Steel.

Square Head Set Screws NC Cup Point



Stocked in Steel - Plain.

Slotted Truss Machine Screws NC



Stocked in Steel Zinc Plating.

Phillips Flat Machine Screws NC



Stocked in Steel Zinc Plating.  
Available in 18-8 Stainless Steel and Black Oxide.

Hex Washer Head Thread Forming Screws Type F



Stocked in Steel Zinc Plating.

Phillips Flat Machine Screws NF



Stocked in Steel Zinc Plating.  
Available in 18-8 Stainless Steel and Black Oxide.

Torx Flat Head Thread Forming Screws Type F



Stocked in Steel Plain.

Phillips Pan Machine Screws NC



Stocked in Steel Zinc Plating.  
Available in 18-8 Stainless Steel and Black Oxide.

Phillip Flat Head Thread Forming Screws Type F



Stocked in Steel Zinc Plating.

Fasteners

Phillips Pan Machine Screws NF



Stocked in Steel Zinc Plating.  
Available in 18-8 Stainless Steel and Black Oxide.

Phillip Pan Head Thread Forming Screws Type F



Stocked in Steel Zinc Plating.

Phillip Truss Machine Screws NC



Stocked in Steel Zinc Plating.  
Available in 18-8 Stainless Steel and Black Oxide.

Phillips Flat Metric Machine Screws



Stocked in Steel Zinc Plating.

Phillips Round Machine Screws NC



Stocked in Steel Zinc Plating.

Phillips Pan Metric Machine Screws



Stocked in Steel Zinc Plating.



### Phillips Truss Metric Machine Screws



Stocked in Steel Zinc Plating.

### J Bolts



Stocked in Steel Zinc plating.

### Hanger Bolts



Stocked in Steel - Plain.

### S Hooks



Stocked in Steel Zinc Plating.

### Dowel Screws



Stocked in Steel - Plain.

### Closed S Hook



Stocked in Steel Zinc Plating.

### Turned Eye Bolts NC



Stocked in Steel Zinc Plating.

### Cup Hooks



Stocked in Solid Brass.

### Screw Eyes



Stocked in Steel Zinc Plating.

### All Thread Rod

Fasteners



Stocked in Steel Zinc Plating.  
Available in Stainless Steel and Plain.

### Screw Hooks



Stocked in Steel Zinc Plating.

### Dowel Pins



Stocked in Steel - Plain.

### Acoustical Eye Lags



Stocked in Steel - Zinc.

### Spring Pins



Stocked in Steel - Plain.

### Cotter Pins



Stocked in Steel - Plain. Available in Stainless Steel and Aluminum.

### Clevis Pins



Stocked in Steel - Plain.

### Hex Nuts Grade 2 - NC



Stocked in Steel Zinc Plating. Available in 18-8 Stainless Steel Hot Dipped Galvanized, Plain, and Black Oxide.

### Hex Nuts Grade 2 - NF



Stocked in Steel Zinc Plating. Available in 18-8 Stainless Steel, Plain, and Black Oxide.

## Fasteners

### Hex Nuts Grade 5 - NC



Stocked in Steel Zinc Plating. Available in Plain.

### Hex Nuts Grade 5 - NF



Stocked in Steel Zinc Plating. Available in Plain.

### Hex Nuts Grade 8 - NC



Stocked in Steel Zinc Plating. Available in Plain.

### Hex Jam Nuts Grade 2 - NC



Stocked in Steel Zinc Plating.

### Hex Jam Nuts Grade 2 - NF



Stocked in Steel Zinc Plating.

### A-325 Hex Nuts



Stocked in Steel - Plain.

### Keps Nuts



Stocked in Steel Zinc Plating.

### Class "C" Locknuts - NC



Stocked in Steel Zinc plating.

### Class "C" Locknuts - NF



Stocked in Steel Zinc plating.

### Nylon Locknuts NC



Stocked in Steel Zinc plating. Available in 18-8 Stainless Steel.



### Nylon Locknuts NF



Stocked in Steel Zinc Plating.  
Available in 18-8 Stainless Steel.

### Stamped Wing Nuts



Stocked in Steel Zinc Plating.

### Hex Jam Nylon Locknuts NC



Stocked in Steel Zinc Plating.  
Available in 18-8 Stainless Steel.

### Square Nuts

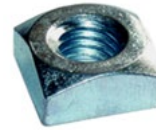

Stocked in Steel Zinc Plating.

### Hex Jam Nylon Locknuts NF



Stocked in Steel Zinc Plating.  
Available in 18-8 Stainless Steel.

### Acorn Nuts



Stocked in Steel Nickel Plating.

### Serrated Flange Locknuts



Stocked in Steel Zinc Plating.

### T-Nuts NC



Stocked in Steel - Plain.

### Center Locknuts



Stocked in Steel Zinc Plating.

### Weld Nuts NC



Stocked in Steel - Plain.

Fasteners

### Coupling Nuts



Stocked in Steel Zinc Plating.  
Available in Black Oxide.

### Metric Hex Nuts



Stocked in Steel Zinc Plating.  
Available in Black Oxide.

### Cold Forged Wing Nuts



Stocked in Steel Zinc Plating.

### Metric Serrated Flange Locknuts



Stocked in Steel Zinc Plating.  
Available in Black Oxide.



### USS Flat Washers



Stocked in Steel Zinc plating.  
Available in 18-8 Stainless Steel,  
Black Oxide, and Plain.

### Nylon Flat Washers



### SAE Flat Washers



Stocked in Steel Zinc plating.  
Available in 18-8 Stainless Steel,  
Black Oxide, and Plain.

### Medium Split Lock Washers



Stocked in Steel Zinc Plating.  
Available in 18-8 Stainless Steel,  
Brass, Black Oxide, and Plain.

### Fender Washers



Stocked in Steel Zinc Plating.  
Available in Stainless Steel,  
Black Oxide, and Plain

### Dome Washers



Stocked in Steel Zinc plating.

### USS Flat Washers Grade 8



Stocked in Steel Yellow Zinc Plating.  
Available in Plain.

### External Tooth Lock Washers



Stocked in Steel Zinc plating.

### SAE Flat Washers Grade 8



Stocked in Steel Yellow Zinc Plating.  
Available in Plain.

### Internal Tooth Lock Washers



Stocked in Steel Zinc plating.

### AN Washers



Available in Zinc, Cadmium, Yellow  
Zinc, Stainless Steel, and Black Oxide.

### Metric Flat Washers



Stocked in Steel Zinc plating.

### A-325 Flat Washers



Stocked in Steel - Plain.

### Metric Medium Split Lock Washers



Stocked in Steel Zinc plating.

Fasteners



## Finish Washers



Stocked in Steel Yellow Nickel Plating. Available in 18-8 Stainless Steel, Brass, and Black Oxide.

## Steel Backed Neoprene Washers



Stocked in Steel Zinc plating.

## Blind Rivets



Aluminum/Aluminum  
Steel/Steel  
Aluminum/Steel  
Stainless Steel/Stainless Steel

## Gutter Spikes



Stocked in Galvanized.

## Roofing Nails



Stocked in Galvanized.

## Box Nails



Stocked in Bright.

Fasteners

## A

A325 Hex Nut 216  
 A325 Structural Bolt 213  
 A325 Washer 218  
 Abrasives  
     3M 176-177, 179-180, 183-185  
     3x4 Sheets 176, 178  
     9x11 Sheets 176  
     Backup Pad 177-178, 185  
     Belts 181-182  
     CGW 180-182  
     Cut-Off Wheels 183  
     Cutting & Grinding Wheels 184-185  
     Disc Rolls  
     Discs 178-181  
     Flap Discs 184-185  
     Hand Pads 179  
     Quick Change Discs 184  
     Resin Fibre 183  
     Sander Replacement Parts 177  
     Sanders 176-177  
     Sanding Belts 181-182  
     Sanding Pads 179  
     Sanding Sponges 179  
     Surfprep 177-178  
     Tack Pad 179  
     Wide Belts 181-182  
 Accuscribe 157  
 Acorn Nuts 217  
 Acoustical Eye Lag 215  
 Acrylic Painters Caulking 171  
 Adhesives  
     Booth Coating 167  
     Caulking 171-172  
     Contact 167  
     Countertop Glue  
     Edgebanding Pellets 168  
     Glue Bottles 168  
     Glue Capsules 168  
     Hot Melt Sticks 169  
     Scotch Weld 168-170  
     Spray 171  
     Wood Glue 167-168  
 Adwood Edgebanding 107  
 Adjustable Round Closet Rod 101  
 Aircraft Extension Bits 197  
 All Thread Rod 215  
 Aluminum Foil Tape 175  
 Amana Tools 185-193  
 Amerock  
     Decorative Hardware 137-145  
     Self Closing Hinge 16  
 Anchors  
     Auger 208  
     Auger Toggle 208  
     Concrete Screws 209  
     Conical 208  
     Kap Toggle 208  
     Nail-In 209  
     Pins 210  
     Poly Toggle 208  
     Power Loads 210  
     Sleeve 209  
     Toggle Wings 208  
     Tubular 209  
     Wall Dog 208  
     Wedge 209  
 AN Washer 218

Angle Mounting Plates 5  
 Appliance Lift 57  
 Arch Pulls 131  
 Auger Anchor 208  
 Auger Toggle 208

## B

Babebot 162  
 Backup Pads 177-178, 185  
 Bags, Poly 166  
 Bainbridge  
     Shelf Supports 121-122  
     Spacers 28-9  
     Touch Drawer Opener 121  
 Ball Bearing Guides 191  
 Ball Bearing Slides 33-34  
 Ball Catch 17, 120  
 Bandsaw Blades 193  
 Barn Door Hardware 94-96  
 Base Cabinet Pull Out 55-56  
 Base Filler 54  
 Base Organizer 55  
 Beaded/Fluted Fillers 91  
 Beaded/Fluted Rosettes 91  
 Bed Fittings 105  
 Bed Lock Headboard Bracket 105  
 Bed Mechanism 25  
 Belt Rack 71-72  
 Belts, Sanding 181-182  
 Berenson, Decorative Hardware 146-147  
 Bi-Fold Hinge 15  
 Biscuits 111  
 Bit Holders 196  
 Bits  
     Aircraft Extension 197  
     Black & Gold 197  
     Boring 199  
     Brad Point Machine 199  
     Cobalt Jobber 198  
     Double End 198  
     Dowel 199  
     Drill 197-199  
     Hex Keys 196  
     Holders 196  
     Insert 194-195  
     Jobber 196-197  
     Machine 199  
     Masonry 198  
     Metric Jobber 198  
     Nutsetter 196  
     Power 195  
     Router 185-191  
     Spade 199  
     Step 199  
     Stubby/Screw Machine 198  
     Through Point 199  
     Vix 199  
 Black & Gold Bits 197  
 Blades  
     Bandsaw 193  
     Hacksaw 192  
     Jigsaw 193  
     Razor 192  
     Saw 193  
     Sawzall 192  
     Utility 192



# Index

Blind Corner Hinge 2-3  
Blind Corner Pull Out 53  
Blind Rivets 219  
Blue Masking Tape 174  
Blue Nitrile Gloves 164  
Bolts  
    Carriage 212  
    Draw Bolts 207  
    Eye 215  
    Flip 160  
    Hanger Bolt 215  
    Hex Cap 212-213  
    J Bolts 215  
    Joint Connector 118  
    Structural 213  
Bondo 151  
Boring Bits 199  
Boring Machine 3  
Bortoluzzi 97-98  
Box Nails 219  
Box Sealing Tape 174  
Brackets  
    ADA Toe Kick 104  
    Corner 106  
    Flat 106  
    Keyhole 105  
    Offset 106  
    Pull Out Mounting 40, 107  
    Shelf 102-103  
    Shelf & Rod 49  
    Support 104  
    U 113  
Brad Nailers 202-203  
Brad Point Machine Drills 199  
Brads  
    Senco 201  
    Generic 201  
Bubble Wrap 154  
Bumpers 110  
Bunn Foot 92  
Butt Hinges 20-23  
Button Head Socket Cap Screws 213

## C

Cabinet  
    Installation Screws 205  
    Levelers 114  
    Security 64  
Cable Clamp 123  
Cam Fittings 126  
Cam Lock 126  
Cam Lock Hasp 125  
Camfix 116  
Cap Screws  
    Button Head Socket NC 213  
    Button Head Socket NF 213  
    Flat Head Socket NC 213  
    Flat Head Socket NF 213  
    Hex Socket Metric 213  
    Hex Socket NC 213  
    Hex Socket NF 213  
Cap Screw, Hex Head 212-213  
Carlson Mfg. Lid Supports 26  
Carriage Bolts 212  
Carton Sealing Tapes 174  
Carton Staples 200

Casters 111-112  
Castle Cap 109  
Catches  
    Ball 17, 120  
    Elbow 18, 120  
    Keku 120  
    Internal Spring Roller 18, 119  
    Magnetic 18-19, 118-119  
    Magnetic Touch 119  
    Non-Magnetic Touch 120  
    Receiver 18, 119  
    Roller 18, 119  
    Round Mortise 17, 119  
Caulk Gun, Half Barrel 171  
Caulking 171-172  
Center Locknuts 217  
Center Mount Drawer Slides 42  
CGW  
    Cutting & Grinding Wheels 184  
    Flap Discs 184-185  
    Quick Change Discs 184  
    Resin Fibre Discs 183  
    Rubber Backup Pad 185  
    Sanding Belts 182  
    Sanding Discs 180-181  
Chain Bolt 120  
Charging Drawer 60  
Child Lock 64  
Citrus Base Adhesive Cleaner 166  
Citrus Cleaner 166  
Class "C" Locknuts 216  
Clear View Rod 18  
Clevis Pins 216  
Clips, Shelf Standard 101  
Closet Hanging Rail 100  
Closed S Hook 215  
Closet Basket Pull Out 68  
Closet Door Track Sliding 101  
Closet Hardware 97-101  
Closet Rod 97, 101  
Closet Sockets 99  
Cloud Pull Out 53  
Coat Hook 100  
Cobalt Jobber Bits 198  
Color Putty  
    Oil Based 173  
    Water Based 173  
Color Wiping Rags 166  
Cookware Organizer 56  
Columns 90  
Computer Keyboard Drawers 45  
Computer Keyboard Slides 44  
Concrete Screws 209  
Confirmat Screw 117  
Conical Anchors 208  
Connecting Fittings 116-118  
Connecting Sleeve 117  
Connector Bolt 118  
Connector Nut 117  
Connector Screw 117  
Connectors, Striplox 115  
Contact Adhesive 167  
Control Panel 130  
Convenience Hardware  
    Appliance Lift 57  
    Base Cabinet Pull Out 55-56  
    Base Filler 54  
    Base Organizer 55  
    Belt Rack 71-72  
    Blind Corner Pull Out 53

# Index

## Convenience Hardware

Cabinet Pull-Out 54-56  
Cabinet Security 64  
Charging Drawer 60  
Child Lock 64  
Closet Basket Pull Out 68  
Cloud Pull Out 53  
Cookware Organizer 56  
Corner Organizer 86  
Cutlery Insert 61  
Cutlery Tray 62  
Cutlery Tray Insert 61  
Cutting Board Drawer 60  
Cutting Drawer 60  
Door Mount Kits 49, 84  
Door Storage Tray 59  
Drawer Divider 62  
Drawer Peg System 57-58  
Drip Tray 64  
Drop In Organizer 57  
False Front Tray Hinges 63  
False Front Trays 63-64  
File Drawer System 76  
Flap Stay 68  
Fly Moon 85  
Fly Moon Mechanism 86  
Glideware Pull Out 56  
Grooming Organizer 65  
Half Moon 52  
Hamper 66-68  
Ironing Board 74-75  
Jewelry Drawer 75-76  
Jewelry Drawer Insert 75  
Knife Block 55, 61  
Knife Block Insert 61  
Knife Holder/Cutting Board Drawer 60  
Lazy Susans  
    Kidney 51-52, 85  
    Pie Cut 50, 52  
    Round 50-51, 85  
    Super 85  
    Wood 50-51, 85  
Magnetic Lock 64  
Mirror, Swivel 71  
Mixer Lift 57  
Outlet Drawer 60, 66  
Pant Rack 70  
Pantry Pull Out 54  
Pantry Unit 87  
Peg System 57-58  
Pivoting Fly Moon 85  
Pop Up Ironing Board 74  
Pull Down Closet Rod 69  
Pull Out Hamper 66-67  
Pull Out Ironing Board 74-75  
Pull Out Shelves 57  
Pull Out Waste Bin 47-49, 84  
Range Hood 89  
Replacement Waste Container & Lids 49, 84  
Rev-A-Lock 64  
Rev-A-Motion 47-48  
Rev-A-Shelf 47-76  
Roll-Out Hamper 66-67  
Rotating Pantry Unit 87  
Scarf Rack 72  
Servo Drive 47, 49  
Shoe Rail 71  
Sink Front Trays 63-64  
Slide Out Blind Corner 53  
Sliding Spice/Can Rack 58

## Convenience Hardware

Sliding Wine Rack 58  
Spice Drawer Insert 60, 87  
Spice Holder Pull-Out 86-87  
Spice Rack 59  
Spring Tension Track System 88  
Stainless Tip Out 63  
Stemware Rack Moulding 58, 88  
Swivel Closet Mirror 71  
Tambour Doors 88  
Tie Rack 72-73  
Tilt-Out Hamper 67-68  
Tip-Out Hinges 63  
Tip-Out Trays 63-64  
Track System 88-89  
Trash Bin Pull-Out 47-49, 84  
Trash Containers 49, 84  
Tray Divider 59  
Utensil Tray Insert 62  
Utility Knife Insert 61  
Valet Rod 69-70  
Vanity Drawer Organizer Insert 65  
Vanity Organizer 65  
Vanity Outlet Drawer 65  
Vanity Outlet Organizer 65  
Ventilator Power Module 89  
Wall Cabinet Pull Out 54  
Wall Filler 54  
Waste Container 47-49, 84  
Waste Pull-Out 47-49, 84  
Wine Rack 58, 88

## Corbels 92

Corner Braces 106, 109-110  
Corner Bracket 106  
Corner Hinge 2-3  
Corner Organizer 86  
Corrugated Fasteners 200  
Cotter Pins 216  
Cotton Wiping Rags 166  
Counterbore for Face Frame Machines 192  
Countersinks 19  
Coupling Nuts 217  
Cover Caps 107, 151  
Cross Dowel Nuts 117  
Crown Molding 91  
Cup Hooks 215  
Custom Color Punch Kit 153  
Cut-Off Wheels 183  
Cutlery Insert 61  
Cutlery Tray Insert 61  
Cutting & Grinding Wheels 184-185  
Cutting Board Drawer 60  
Cutting Drawer 60  
Cutting Wheels 165

## D

### Decorative Hardware

Amerock 137-145  
Berenson 146-147  
Emtek 148  
Import 131-136  
Schaub & Company 149  
Top Knob 150  
Delta Lid Stay 26  
Dentil Moulding 91  
Desk Top Fasteners 104



# Index

Diffusers 80  
Dimmable Power Supply 78  
Dimmer 79-80  
Dimmer, Touch 130  
Disc Tumbler Locks 127-128  
Discs  
    Flap 184-185  
    Quick Change 184  
    Resin Fibre 164  
    Sanding 158-161  
Dollies 112  
Door  
    Bumpers 110  
    Spacers 110  
Door Hardware  
    Barn 94-96  
    Butt Hinges 23  
    Sliding 97-98  
Door Mount Kits 49, 84  
Door Spacers 110  
Door Storage Tray 59  
Double End Drill Bits 198  
Double Wrap Hinge 22  
Dowel Bits 199  
Dowel Glue Capsules 168  
Dowel Pins 213  
Dowel Screws 215  
Dowels, Wooden 111  
Dowels for Cams 116  
Draw Bolts 207  
Drawer  
    Cutlery 61  
    Side Spacers 29  
    Stand-Off 28  
Drawer Bumper 159  
Drawer Divider 62  
Drawer Front Adjustor 116  
Drawer Front Adjustor Screws 204  
Drawer Locks 124-128  
Drawer Peg System 57-58  
Drawer Slide Screws 204  
Drawer Slides  
    Accessories 28  
    Ball Bearing 33-44  
    Center Mount 42  
    Computer Keyboard 44  
    Dynapro 34-35  
    Dynaslide 40, 42  
    European 27-28  
    F70 36  
    Full Extension 34-42  
    Fulterer 40-41  
    Futura Smove 37  
    Grass 31-35  
    Harn 25, 30-31  
    Heavy Duty 41-42  
    Impaz 30-31  
    Import 27, 38-44  
    KV 42-44  
    Metal Box Drawer System 31-34  
    Pocket Door 42-43  
    Salice 27, 36-38  
    Self Close 27-28  
    Sockets 27, 29  
    Soft Close 34-39, 41  
    Titusoft 28  
    Touch to Open 39  
    Undermount 34-38  
    Vionaro 31-32  
    Z-Box 33

Drawer Slides  
    Zargen 33-34  
Drill Bits  
    Aircraft Extension 197  
    Boring 199  
    Brad Point 199  
    Cobalt 198  
    Double End 198  
    Dowel 199  
    Jobber 196-197  
    Masonry 198  
    Screw Machine 198  
    Spade 199  
    Step 199  
    Stubby 198  
    Vix 199  
Drill Screws  
    Hex Washer Head 211  
    Phillips Bugle Drywall 210  
    Phillips Flat 212  
    Phillips Modified Truss 212  
    Phillips Oval 212  
    Phillips Oval Sems 212  
    Phillips Pan 212  
    Phillips Pan Framing 210  
    Phillips Wafer Head 212  
    Square Pan 212  
    Square Trim Head 211  
Drop In Organizer 57  
Drop Leaf Hinge 15  
Drywall Drill Screw 210  
Drywall Screws 206, 210  
Duct Tape 175  
Duplo Pin 121  
Dust Masks 164  
Dust Respirators 164  
Dynapro, Grass 34-35  
Dynaslide 40, 42

## E

Ear Plugs 164  
Edge Guide 203  
Edgebanding 107-108  
Edgebanding Glue 168  
Elbow Catch 18, 120  
Electric Trim Ring 160  
Electric TV Lifts 26  
Electrical Harness 130  
End Nip Trimmers 156  
Epoxy Putty 173  
Equiline LED Flextape 78  
Equiline Puck Lights 77  
Ergonomic  
    Keyboard Arms 45  
    Keyboard Trays 45  
Euro Screws 207  
European  
    Drawer Slide 27-28  
    Face Frame Hinge 13-15  
    Hinges 1-3, 9-15  
    Mounting Plates 4-5, 9, 11-12  
Extensions for Sockets 196  
External Tooth Lock Washer 218  
Extrusions 105  
Extrusions Lights 81-83  
Eye Bolt 215

**F**

F70 Slides 36  
 Face Frame  
     Hinges 13-15  
     Mounting Plates 5, 9, 11-12  
     Screws 206  
 Face Frame Hinge  
     Grass 14  
     Import 14-15  
     Salice 13  
 False Front Clips 110  
 False Front Tray Hinges 63  
 False Front Trays 63, 64  
 Famowood 172  
 FastBreak 158  
 FastBreak Sandpaper 158  
 Fastcap Tools 151-163  
 Fastcaps 151  
 Fastedge 109, 151  
 FastWrap 158  
 Fatboy Pencil, The 158  
 Fender Washers 218  
 Filament Strapping Tape 175  
 File Card With Brush 183  
 File Drawer System 76  
 File Fittings 129  
 File Rods 129  
 Files  
     All Purpose 183  
     Round 183  
 Fillers, Beaded/Fluted 91  
 FineLine Light 79  
 Finish Nails 201  
 Finish Washers 219  
 Finishing Plugs 109  
 Flap Discs 184-185  
 Flap Lift 25  
 Flap Stay 68  
 Flat Brackets 106  
 Flat Panel TV Supports 26  
 Flat Rail Barn Door Hardware 94-95  
 Flat Washers 218  
 FLEX Screw Bag 154  
 FLEX Tool Bag 154  
 Flexa-Touch Drawer Opener 121  
 Flip Bolt 160  
 Floor Glides 113  
 Flush Mount Drill Bit System 152  
 Flush Sliding Pulls 133  
 Fluted Wood Dowels 111  
 Fly Moon, Pivoting 2-Shelf 85  
 Fly Moon Mechanism 86  
 Foam Sheeting 175  
 Framing Screws, Phillips Pan 210  
 Franklin Glue 167  
 FREEDiM Dimmers 79-80  
 FREEDiM Wireless Door Sensor 80  
 Fret Nippers 156  
 Full Extension Slides 34-42  
 Full Wrap Hinges 17  
 Fulterer Slides 40-41  
 Funnel Screws, Square Flat 205  
 Furniture Fittings 113-114  
 Furniture Levelers 113  
 Futura Smove Slides, Salice 37

**G**

Gang Locks 125  
 General Duty Casters 112  
 Glass Clips 112-123  
 Glass Door Hinges 3, 15  
 Glass Door Strike Plates 121  
 Glasses, Safety 163-164  
 Glides  
     Floor 113  
     Tack 114  
 Glideware Pull Out 56  
 Gloves  
     500NFT 165  
     Disposable 164-165  
     Frogwear 165  
     Latex 165  
     Nitrile Disposable 164  
     Panther-Guard 165  
     Pug-13 165  
     Skins 162  
 Glubot 162  
 Glue 167-168  
 Glue Bottles 168  
 Glue Capsules 168  
 Glue Guns 169-170  
 Glue Sticks 169  
 Grass  
     Compact Hinges 14  
     Dynapro 34-35  
     European Hinges 9-11  
     Kinvaro 24-25  
     Mounting Plates 9-10, 14  
     Nexis Hinges 9  
     Soft Close 10-11  
     Tiomos 10-11  
     Unisoft 11  
     Vionaro 31-32  
     Z Box 33  
     Zargen Drawer Slides 33-34  
 Grex Tools 202-203  
 Grinding Wheels 184-185  
 GRK see U2 Fasteners  
 Grommets 124  
 Grooming Organizer 65  
 Gun Oil 176, 203  
 Guns  
     Nail 202-203  
     Staple 201-202  
 Gutter Spikes 219

**H**

Hacksaw Blades 192  
 Half Facepiece Respirator 164  
 Half Moon Lazy Susan 52  
 Hampers 66-68  
 Hand Sanding Pads 179  
 Hand Sanding Sponges 179  
 Handle On Demand 163  
 Hanger Bolt Driver 196  
 Hanger Bolts 215  
 Hanging File Fittings 129  
 Hanging File Rail 129  
 Hanging File Rods 129  
 Hardwood Closet Sockets 99  
 Heavy Duty Flush Cut Trimmer 156



# Index

Heavy Duty Slides 41-42  
Hex Cap Screws 212-213  
Hex Insert Bits 194-195  
Hex Keys 196  
Hex Lag Screws 212  
Hex Nuts 216  
Hide-a-Bed Mechanism 25  
Hidden Tilt Rod 18  
Hinge Machine 3  
Hinges  
    0 Protrusion 2  
    Amerock 16  
    Bi-Fold 15  
    Blind Corner 2-3  
    Butt 20-23  
    Compact 13-14  
    Concealed 17  
    Continuous (Piano) 23  
    Corner 2-3  
    Double Wrap 22  
    Drop Leaf 15  
    European 1-3, 9-15  
    Face Frame 13-15  
    Face Frame Mounting Plates 5, 9, 11-12  
    Face Mount 16  
    Full Overlay 1-2, 9-12  
    Full Wrap 17  
    Glass Door 3, 15  
    Grass 9-10, 14  
    Grass, Nexis 9  
    Grass, Tiomos 10  
    Half Overlay 1-2, 9-12  
    Import 11, 14-15  
    Inset 1-2, 11-12  
    Institutional 3, 22  
    Invisible 17  
    Mortise 20  
    Mounting Plates 4-5, 9-12  
    Negative Angle 2  
    Non Bore 15  
    Non Mortise 21  
    Partial Wrap 16  
    Piano 23  
    Pie Corner 2  
    Pivot 15  
    Plates, Face Frame 5, 9, 11-12  
    Push 6  
    Reference Page 8  
    RPC - Terry 22  
    Salice 1-3, 13  
    Self Closing 1-3, 9-10, 12, 14-17  
    Shutter 20-22  
    Soft Close 1-3, 10-11, 13-15  
    Spacer, Face Frame 7  
    Spacer, Hinge 7  
    Specialty Profiles 2-3  
    Table Flap Top 15  
    Thick Door 2  
    Tiomos 10-11  
    Traditional  
        Face Mount 16  
        Full Wrap 3/4" 17  
        Partial Wrap 16  
    Wood Pivot 15  
    Wrap Hinges 16-17, 22

Hole Saws, Bi-Metal 192  
Hooks  
    Coat 100  
    Closed S 215  
    Cup 215  
    S 215  
    Screw 215  
Hot Melt Sticks 169

## I

Impaz Drawer System 30-31  
Import  
    Convenience Hardware 84-85  
    Decorative Hardware 131-136  
    Hinges 11, 14-15  
    Mounting Plates 11-12  
    Shelf Brackets 102  
    Shelf Standard 102  
    Slides 27, 38-44  
    Trash Rings 123  
    Wooden Posts 93  
    Wooden Products 92  
Industrial Casters 112  
Infinox Diffusers 80  
Infinox Extrusions 81-83  
Insert Bits  
    Phillips 194  
    Pozi 194  
    Slotted 194  
    Socket 194  
    Square 194  
    Torx 195  
    Torx Security 194  
Insert Nut 117  
Inspector Light 178  
Institutional Hinge 3, 22  
Interlocking Panel Fasteners 105  
Internal Spring Roller Catch 18, 119  
Invisible Hinge 17  
Ironing Board 74-75

## J

J Bolts 215  
J Door Pull 105  
Jasmine Convenience Hardware 86-87  
Jewelry Drawer 75-76  
Jewelry Drawer Insert 75  
Jigsaw Blades 193  
Jobber Bits 196-198  
Joiner Biscuits 111  
Joint Connector Bolts 118  
Joint Connector Lag 118  
Joint Connector Nut 117  
Jowat 168



## K

- Kap Toggle 208
- Keku Fasteners 120
- Keps Nuts 216
- Keyboard Arm 45
- Keyboard Drawer 45
- Keyboard Slide 44
- Keyboard Tray 45
- Keyhole Bracket 105
- Kidney, Lazy Susan 51-52, 85
- Kinetron Rigid Steel File Fittings 129
- Kinvaro 24-25
- Klix Cam 116
- Klix Dowels 116
- Knife Block 55, 61
- Knife Block Insert 61
- Knife Holder/Cutting Board Drawer 60
- Knobs
  - Amerock 137-141, 143-144
  - Berenson 146-147
  - Emtek 148
  - Import 132-136
  - Schaub & Company 149
  - Top Knob 150
- Kolbe Korner 159
- KV
  - Closet Rod 101
  - Desk Top Fastener 104
  - Keyboard Arm 45
  - Slides 42-44

## L

- Lag Screws 212
- Laminate Files 183
- Lazy Susans
  - Kidney 51-52, 85
  - Pie Cut 50, 52
  - Round 50-51, 85
  - Super 85
- LED Connectors 129
- LED Link Cord 78-79
- LED Puck Light Power Cord 129
- LED Puck Lights 77, 130
- LED Strip Lights 129
- LED Under Cabinet Light 129
- Legs 92-93
- Levelers
  - Cabinet 114
  - Furniture 113
- Lid Supports 26
- Lift, Delta 26
- Lift Kit, Salice 24
- Lift System, Salice 24
- Lift Up, Grass 24-25
- Lighting
  - Control Panel 130
  - Dimmable Power Supply 78
  - Equiline LED Flextape 78
  - Equiline Puck Lights 77
  - Flextape 78
  - FREEDiM Dimmers 79-80
  - FREEDiM Wireless Door Sensor 80
  - Headboard Harness 130
  - Infinex Diffusers 80

## Lighting

- Infinex Extrusions 80-83
- LED Connectors 129
- LED Link Cord 78-79
- LED Puck Lights 77, 130
- LED Strip Lights 129
- LED Under Cabinet Light 129
- Link Cord 78-79
- Oval Motion 77
- Power Supply 78
- Puck Lights 77, 130
- Touch Dimmer 130
- Transformer Amp Block 79
- Tresco 77-83
- Wireless Dimmer 79
- Wireless Door Sensor 80

- Little Hand 153
- Link Cord 78-79

## Locks

- Cam 126
- Cam Lock Hasp 125
- Cylinder Core Housings 124
- Disc Tumbler 127-128
- Drawer 125-126 Locks
- Gang 125
- Gang Lock Housings 125
- H Mounting Bracket 125
- Keys 127
- Lock Housings 125
- Lockclip 125
- Pin Tumbler 125-126
- Sash 120
- Showcase/Ratchet 126
- Sliding Door 126
- Spacers 126
- Strike Plate 127

- Lock Washers 227
- Locking Hole Plugs 109
- Locking Shelf Supports 122
- Locknuts 216-217
- Louver Pins see Shutter Pins
- Lube 166

## M

- Machine, Hinge Boring 3
- Machine Screws
  - Metric 214-215
  - Phillips Flat 214
  - Phillips Pan 214
  - Phillips Round 214
  - Phillips Truss 214
  - Slotted Truss 214
- Macro Flush Cut Trimmer 156
- Magnetic Bit Holders 196
- Magnetic Catches 18-19, 118-119
- Magnetic Dust Barrier Door 157
- Magnetic Lock 64
- Magnetic Nutsetters 196
- Masking Tape 174
- Masonry Drills 198
- Masonry SDS Bits 198
- Measuring Tapes 155
- Medium Split Lock Washers 218
- Melaband Edgebanding 107
- Metric Flat Washers 218
- Metric Hex Nuts 217



# Index

Metric Medium Split Lock Washers 218  
Metric Serrated Flange Locknuts 217  
Micro Flush Cut Trimmer 156  
Micropins 201  
Mini Flat Rail Barn Door Hardware 95  
Mirror Clip 122  
Mirror Hanger 123  
Mirror Swivel 71  
Mixer Lift 57  
Modesty Panel Clip 104  
Mortise Hinges 20  
Moulding 91  
Mounting Plates  
    Angle 5  
    Angle Adapter 5  
    Clip-On 4-5, 11-12  
    Euro Screw 4-5, 9, 11-12  
    Face Frame 5, 9, 11-12  
    Inset 5  
    Screw On 4-5, 9  
    Slide On 5  
    Soft Close 11-12

## N

Nail-In Anchors 209  
Nails 201, 219  
Nail Guns 202-203  
Negative Angle Hinge 2  
Neo Tek see Drill Screw  
Neoprene Washers 219  
Nexis Hinges 9  
Nitrile Disposable Gloves 164  
Non Magnetic Touch Latch 120  
Non Mortise Hinges 21  
Nuts  
    A325 216  
    Acorn 217  
    Center Lock 217  
    Class "C" Lock 216  
    Coupling 217  
    Cross Dowel Nut 117  
    Hex Grade 2 216  
    Hex Grade 5 216  
    Hex Grade 8 216  
    Hex Jam Grade 2 216  
    Insert Nut 117  
    Joint Connector 117  
    Keps 216  
    Metric Hex 217  
    Metric Serrated Flange Lock 217  
    Nylon Lock 217  
    Serrated Flange Lock 217  
    Square 217  
    T 217  
    Weld 217  
    Wing 217  
Nutsetters 196  
Nylon Lock Nuts 216-217

## O

100% Silicone Caulking 171  
Offset Bracket 106  
Olympus Locks 125-128  
Omega National 85, 87-91  
Onlays 92  
Orbital Sanders 176-177  
Outlet Drawer 60, 66  
Oval Closet Rod 99  
Oval Closet Rod Fittings 99  
Oval Motion, Dimmer 77  
Oval Shelf & Rod Bracket 99

## P

Painters Caulking 171  
Panel Fasteners 105, 122-123  
Panel Retaining Button 123  
Pant Rack 70  
Pantry Pull Out 54  
Pantry Unit, Rotating 87  
Paper Masking Tape 175  
Particle Board Screws  
    Phillips Flat 205  
    Phillips Flat TY17 With Nibs 205  
    Square Flat 205  
    Square Pan 205  
    Square/Phillips Flat TY17 With Nibs 206  
    Square/Phillips Round Washer Head 206  
Pasco Abrasives see CGW Abrasives  
Patwin T-Moulding 108  
Peel & Stick Tape Measures 156  
Peg System 57-58  
Pencil Drawer 45  
Phillips Threaded Bit 194  
Piano Hinge 23  
Pie Corner Hinge 2  
Pie Cut, Lazy Susan 50, 52  
Pilasters 101  
Pins  
    Clevis 216  
    Cotter 216  
    Dowel 215  
    Duplo 121  
    Shelf 121  
    Spring 215  
    Straight 121  
Pins & Brads 201  
Pivot Hinge 15  
Pivoting Shelf Fly Moon 85  
Plastic Corner Braces 109-110  
Plastic Grommets 124  
Plastic Shelf Supports 121-122  
Plates  
    Mounting 4-5, 9, 11-12  
    Striker 19, 120-121  
Plugs  
    Plastic 109  
    Wood 111  
Pneumatic Staple and Nail Guns 201-203  
Pocket Chisel 155  
Pocket Chisel Case 155  
Pocket Chisel Kit 155  
Pocket Combo Putty Knife 155  
Pocket Diamond Sharpener 155

Pocket Door Slides 42-43  
Pocket Door System 97  
Pocket Putty Knife 155  
Pop Up Ironing Board 74  
Poly Bags 166  
Poly Strapping Tape 175  
Porcelain Knobs 133  
Posts 93  
Power Bits  
    2 Piece Square 195  
    Phillips 195  
    Square 195  
Power Loads and Pins 210  
Power Mags 157  
Power Shears 156  
Power Supply 78  
Power Tools 201-203  
PowerHead Screws 159  
Pozi Screwdriver 7  
ProCarpenter Tape Measures 155  
Puck Lights, LED 77, 130  
Pull Down Closet Rod 69  
Pull Out Hamper 66-67  
Pull Out Ironing Board 74-75  
Pull Out Mounting Bracket 40, 107  
Pull Out Shelves 57  
Pull Out Swivel 46  
Pull Out Trash Containers 47-49, 84  
Pull Out Waste Bin 47-49, 84  
Pulls  
    Amerock 137-144  
    Appliance 145  
    Arch 131  
    Bar 132  
    Berenson 146-147  
    Bow 131  
    Emtek 148  
    Flush Sliding 133  
    Import 131-136  
    Plastic 131-132  
    Plastic Wire 131  
    Schaub & Company 149  
    Top Knob 150  
Push Latch, Titus 6  
Putty 173  
Putty Pencils 174  
PVC Edgebanding 108  
PVC Track System 89

## Q

Quad Screws see Square/Phillips Screws  
Quad Trimmer 152  
Quick Change Discs 185  
Quick Screws 204-206  
Quickfit Dowels 116  
QuickTRAY 29  
Qwikdraw 160

## R

Rags 166  
Rail, Suspension 100  
Rail Bracket Cover, Suspension 100  
Rail Brackets, Suspension 100  
Rail Cover, Suspension 100  
Random Orbit Sander 176-177  
Range Hood 89  
Razor Blades 192  
Real Solutions 84  
Receiver Catch 18, 119  
Red Devil 171  
Reference Hinge Page 8  
Reduction Clips 7, 10  
Reeve 102-103  
Reinforced Cutoff Wheels 183  
Resin Fibre Discs 183  
Respirators 164  
Rev-A-Lock 64  
Rev-A-Motion 47-48  
Rev-A-Shelf  
    Convenience Hardware 47-76  
    Lighting 77-83  
Rivets, Blind 219  
RocLoc 161  
Roll-Out Hamper 66-67  
Roller Catches 18, 119  
Roo Glue 168  
Roofing Nails 219  
Rosettes 91  
Rotating Pantry Unit 87  
Round Closet Rod 99  
Round Closet Rod Fittings 99  
Round Lazy Susan 50-51, 85  
Round Rail Barn Door Hardware 94-95  
Router Bits  
    4 Wing Bevel Trim Cutter 187  
    Ball Bearing Guides 191  
    Beading 191  
    Bevel Trim 189  
    Chamfer Bits 191  
    Core Box 190  
    Corner Beading 186  
    Corner Rounding 190  
    Cove 190  
    Dado Clean Out 187  
    Dovetail 190  
    Down Shear Face Plunge Template 187  
    Flush Trim 189  
    Laminate Trim 188  
    Mortising 186  
    Multi Rabbet 188  
    Panel Pilot 186  
    Rabbet 188  
    Raised Panel 186  
    Roman Ogee 189  
    Slotting Cutters 189  
    Stile and Rail 186  
    Straight 185-186  
    Top Bearing Trim 187  
    V Groove 189



# Index

## S

- 6 Point Socket 195
- S Hooks 215
- Safety Glasses 163-164
- Salice
  - Accessories 7
  - Bortoluzzi 97-98
  - Closet Hardware, Bortoluzzi 97-98
  - Compact Hinges 13
  - Convenience Hardware 84-87
  - Drawer Slides 27, 36-37
  - F70 Slides 36
  - Face Frame Hinges 13
  - Futura 37
  - Glass Door Hinges 3
  - Hinge Machine 3
  - Hinge Spacer 7
  - Hinges 1-3, 13
  - Institutional Hinge 3
  - Lifts 24
  - Mounting Plates 4-5
  - Pocket Door System 97
  - Push to Open 6
  - Reduction Clips 7
  - Reference Guide 8
  - Slides 27, 36-37
  - Sliding Systems 97-98
  - Smove 6
  - Wind 24
- Sanders 176-177
- Sanding Belts 181-182
- Sanding Discs 178-181
- Sanding Sheets 176, 178
- Sanding Sponges 179
- Sandpaper see Abrasives
- Sash Lock 120
- Saw Blades 193
- Sawzall Blades 192
- Scarf Rack 72
- Schaub & Company, Decorative Hardware 149
- Scotch-Brite 179
- Scotch-Weld 168-170
- Screws
  - Connector 117
  - Dowel 215
  - Drawer Front Adjustor 204
  - Drawer Slide 204
  - Drill 210-212
  - Drywall 206, 210
  - Euro 207
  - Face Frame 206
  - Framing 210
  - Hex Cap 212-213
  - Lag 212
  - Machine 214-215
  - Particle Board 205-206
  - Set 213-214
  - Socket Cap 213
  - Tapping 204, 211
  - Thread Forming Type F 214
  - Trim Head 210-211
  - Type 17 204-206
  - U2 Fasteners 207-208
  - Wood 212
  - Zap 211
- Screw Caps 107, 151
- Screw Driver Bits 194-195
- Screw Eyes 215
- Screw Hooks 215
- Screwdriver, Pozi 7
- Selby Bed Mechanism 25
- Self Closing Hinges 1-3, 9-10, 12, 14-17
- Self Closing Slides 27-28
- Senclamp 200
- Senco 200-202
- Senco Tools 201-202
- Serrated Flange Locknuts 217
- Servo Drive 47, 49
- Set Screws 213-214
- Sharp Point see Zap Screws
- Shelf Brackets 102-103
- Shelf Clips 121
- Shelf Standard 101-103
- Shelf Stiffener 105
- Shelf Support 121-122
- Shims 166
- Shoe Rail 71
- Shutter Hardware
  - Ball Catch 17
  - Elbow Catch 18
  - Hidden Tilt Rod 18
  - Hinges 20-22
  - Internal Spring Roller Catch 18, 119
  - Magnetic Catch 18-19
  - Nylon Washer 19
  - Receiver Catch 18
  - Shutter Pins 19
  - Springs 17
  - Strike Plates 19
- Shutter Pins 19
- Side Spacer 29
- Silicone Caulk 171
- Silicone Lubricant 166
- Simonds Files 183
- Sink Front Trays 63-64
- Skins HD Gloves 162
- Slatwall Hardware 102-103
- Sleeve Anchor 209
- Slide Out Blind Corner 53
- Slide Pencil Drawer Tray 45
- Slides see Drawer Slides
- Sliding Door Hardware 97-98, 101
- Sliding Spice/Can Rack 58
- Sliding Wine Rack 58
- Sliding Systems, Salice 97-98
- Sliding Track 101
- Smart Cleat 161
- Smart Clip 108
- Smove 6
- Socket Cap Screw 210-214
- Sockets
  - 6 Point 195
  - Closet 99
  - Drawer Slide 27, 29
- Soft Closing
  - Hinges 1-3, 10-11, 13-15
  - Mechanism Slide 28
  - Slides 34-39, 41
- Softwax 161
- Spacers
  - Door 110
  - Drawer 28
  - Side 29
  - Stand Off 28
  - Step 29
  - Undermount 28
- Spackle 173
- Spackling Compound 173
- Spade Bits 199

# Index

Speed Brace 160  
Speed Brace Stealth 161  
Speed Clip 156  
Speed Dollie 153  
Speed Roller Pro 152  
Speed Tape 152  
Spice Drawer Insert 60, 87  
Spice Holder Pull-Out 86-87  
Spice Rack 59  
Spiral Wood Dowels 111  
Split Rope Moulding 91  
Spray 20 171  
Spray 24 171  
Spray 27 171  
Spray Adhesive 171  
Spring Loaded Sash Lock 120  
Spring Pins 215  
Spring Roller Catch 18, 119  
Spring Tension Track System 88  
Springs 17  
Square Drive Screws 205-206, 211-212  
Square Nuts 217  
Square/Phillips Screws  
    Flat Particle Board 206  
    Round Washer Head Particle Board 206  
Stafast  
    Cross Dowel Nut 117  
    Insert Nut 117  
    Joint Connector Bolts 118  
    Joint Connector Lag 118  
    Joint Connector Nut 117  
Stainless Tip Out 63  
Stand Off 28  
Standard 101-103  
Standard Brackets 102-103  
Staple Guns 201-202  
Staple Setter 163  
Staples  
    Carton 200  
    Corrugated 200  
    Fine Wire 200  
    Generic 200  
    Hammer 200  
    Heavy Wire 200  
    L Wire 200  
    Medium Wire 200  
Steel Wool 179  
Stemware Holder 58, 88  
Stemware Rack 88  
Step Spacer 29  
Straight Pin 121  
Stretch Wrap 175  
Strike Plates 19, 120-121  
Strip Lights, LED 129  
Striplox 115  
Structural Bolts, A325 213  
Stubby Bits 195  
Sugatsune, Non Magnetic Touch Latch 120  
Super Mag 157  
Super Susans 85  
Support Bracket 104  
Support Bracket, Wooden 89  
Surfprep Abrasives 177-178  
Suspension Rail 100  
Suspension Rail Bracket Covers 100  
Suspension Rail Brackets 100  
Suspension Rail Covers 100  
Swivel Closet Mirror 71  
Swivels  
    Bar Stool 46

Swivels  
    Pull Out 46  
    Square 46

## T

2P-10 Adhesive 162  
35 Year Acrylic Caulking 171  
3M  
    Abrasives 176-177, 179-181  
    Adhesives 167-171  
    Air Tools 171  
    Aluminum Foil Tape 175  
    Backup Pads 177  
    Box Sealing Tape 174  
    Citrus Base Adhesive Remover 166  
    Citrus Cleaner 166  
    Contact Adhesive, Fastbond 167  
    Cutting & Grinding Wheels 184-185  
    Door Bumper 110  
    Double Coated Foam Tape 175  
    Dust Masks 164  
    Dust Respirators 164  
    Ear Plugs 164  
    Flap Discs 184  
    Foam & Fabric Spray 24 171  
    Half Facepiece Respirator 164  
    Masking Tape 174  
    Multi-Purpose Spray 27 171  
    Orbital Sanders 176  
    Paper Masking Tape 175  
    Purple Belts 181  
    Random Orbital Sanders 176  
    Safety Glasses 164  
    Sander Replacement Parts 177  
    Sanding Discs 179-181  
    Sanding Pads 179  
    Sanding Sheets 176  
    Sanding Sponges 179  
    Scotch-Brite 179  
    Scotch-Weld 168-170  
    Silicone Lubricant 166  
    Spray 20 171  
    Spray 24 171  
    Spray 27 171  
    Strapping Tape 175  
    Tape 174-175  
    Tape Dispenser 175  
    Wide Belts 181  
    Woodworking Spray 20 171  
3rd Hand 154  
T-Molding 108  
T-Nuts 217  
Table Legs 93  
Table Top Evener 104  
Tack Glides 114  
Tambour Doors 88  
Tap Bolts see Hex Cap Screws  
Tape  
    Aluminum Foil 175  
    Blue Masking 174  
    Box Sealing 174  
    Dispensers 175  
    Double Coated Foam Tape 175  
    Duct 175  
    Filament Strapping 175  
    Masking 174



# Index

Tape  
    Paper Masking 175  
    3M 174-175  
Tape Dispenser 175  
Tape Measures 155-156  
Taper Bits 191  
Taper Lock 159  
Taper Taps 194  
Tapping Screws  
    Coarse Thread Phillips Flat 204  
    Coarse Thread Phillips Oval 204  
    Coarse Thread Phillips Pan 204  
    Coarse Thread Phillips Round Washer 204  
    Hex Washer Head 211  
    Hex Washer Head Neo 211  
    Phillips Flat 211  
    Phillips Oval 211  
    Phillips Pan 211  
    Phillips Truss 211  
    Square Flat 211  
    Square Pan 211  
    Square Truss 211  
Tek see Drill Screws  
Tenn Tex 29-30  
Thread Connectors 117  
Thread Forming Screw Type F 214  
Tie Rack 72-73  
Tilt Out Hamper 67-68  
Timbermate Wood Filler 173  
Tiomos 10  
Tip Mag 159  
Tip Out Tray Hinges 63  
Tip Out Trays 63-64  
Titebond  
    Caulking 171-172  
    Glue 167  
Titus  
    Camfix 116  
    Connector Fittings 116  
    Covercaps 107  
    Dowels 116  
    Drawer Front Adjuster 116  
    Klix 116  
    Levelers 114  
    Push Latch 6  
    Titusoft 28  
Toe Kick Bracket 104  
Toggle Wings 208  
Toggles 208  
Tools  
    3M 176  
    Fastcap 152-163  
    Grex 202-203  
    Senco 201-202  
    Surfprep 177  
Top Knobs 150  
Touch Drawer Opener 121  
Touch To Open Slides 39  
Track, Sliding Door 97-98, 101  
Track System 88-89  
Transformer Amp Block 79  
Trash Bin Pull Out 47-49, 84  
Trash Containers 49, 84  
Trash Rings 123  
Tray Dividers 59  
Tresco 77-83  
Tri Blade 158  
Triangle Block, Wooden 90  
Trim Head Screws 210-211  
Trim Head Square Drill Screw 211

Trimmer 152  
Tubular Anchors 209  
Tungsten Blades 152  
Turned Eye Bolt 215  
TV Lift 26  
TV Swivel 46  
Twin Wheel Casters 111-112  
Twine 175  
Type 17 Screws 204-206  
Type F Screws 214

## U

U-Bracket 82  
U2 Fasteners  
    Torq Bits 208  
    Torq Flat Screws 207  
    Torq Lag Screws 208  
    Torq Trim Head Screws 207  
Under Mount Slides 34-38  
Under Sink Tray 64  
Undermount Rear Socket 29  
Undermount Spacer 29  
Unisoft 11  
Universal Bracket 102  
Universal Standard 102  
Utensil Tray Insert 62  
Utility Knife Insert 61  
Utility Knives 192

## V

Valet Rod 69-70  
Vanity Drawer Organizer Insert 66  
Vanity Organizer 66  
Vanity Outlet Drawer 65  
Vanity Outlet Organizer 65  
Velcro Discs 178-180  
Veneer Edgebanding 107  
Vent Grill 123  
Ventilator Power Module 89  
Versalift 26  
Vionaro 31-32  
Vix Bits 199

## W

Wall Cabinet Pull Out 54  
Wall Dog 208  
Wall Filler 54  
Washers  
    A325 218  
    AN 218  
    Fender 218  
    Finish 219  
    Flat, Grade 8 218  
    Flat, Metric 218  
    Flat, Nylon 218  
    Flat, SAE 218  
    Flat, USS 218  
    Lock, Dome 218

# Index

---

Washers  
    Lock, External Tooth 218  
    Lock, Internal Tooth 218  
    Lock, Medium Split 218  
    Lock, Medium Split Metric 218  
    Neoprene 219  
    Nylon 218  
    Steel Backed Neoprene 219  
Waste Container 47-49, 84  
Waste Pull-Out 47-49, 84  
Wedge Anchors 209  
Weld Nuts 217  
White Cotton Wiping Rags 166  
White River 92  
Wide Belts 181-182  
Wind Lift, Salice 24  
Wine Rack 58, 88  
Wing Nuts 217  
Wiping Rags 166  
Wire Brads 201  
Wire Clamp 123  
Wire Grommets 123-124  
Wire J Channel 123  
Wireless Dimmer 79  
Wireless Door Sensor 80  
Wood Adornments  
    Import 92-93  
    Omega National 90-91  
    White River 92  
Wood Closet Sockets 99  
Wood Dowels 111  
Wood Filler 172-173  
Wood Glue  
    Franklin 166  
    Roo Glue 167  
    Titebond 166-167  
Wood Lazy Susans 50-51, 85  
Wood Pivot Hinge 15  
Wood Plugs 111  
Wood Putty 172-173  
Wood Screws 212  
Wood Shims 166  
Wooden Legs 92-93  
Wooden Posts 93  
Work Station Brackets 104  
Wrap Hinge  
    Double 22  
    Full 17  
    Partial 16

## X, Y, Z

Z Box Slide 33  
Zap Screws 211  
Zargen Drawer Slides 33-34



## Notes

---

### Conversion Chart

Inches Fractional	Inches Decimal	Metric MM
1/32	.031	.794
1/16	.063	1.59
3/32	.094	2.38
1/8	.125	3.18
5/32	.156	3.97
3/16	.188	4.76
7/32	.219	5.56
1/4	.250	6.35
9/32	.281	7.14
5/16	.313	7.94
11/32	.344	8.73
3/8	.375	9.53
13/32	.406	10.32
7/16	.438	11.11
15/32	.469	11.91
1/2	.500	12.70

Inches Fractional	Inches Decimal	Metric MM
17/32	.531	13.49
9/16	.563	14.29
19/32	.594	15.08
5/8	.625	15.88
21/32	.656	16.67
11/16	.688	17.46
23/32	.719	18.26
3/4	.750	19.05
25/32	.781	19.84
13/16	.813	20.64
27/32	.844	21.43
7/8	.875	22.23
29/32	.906	23.02
15/16	.938	23.81
31/32	.969	24.61
1	1.00	25.40

$$1 \text{ MM} = .0394''$$

$$\text{Metric Dimension} \div 25.4 = \text{Decimal Equivalent}$$



# Notes

---

---

2026 E. Cedar St Tempe, AZ 85281  
Fax: 480-967-1907

**U.S. Industrial Fasteners of AZ, Inc.**



Phone: 480-967-8702  
800-289-5386

# U.S. Industrial Fasteners of Arizona, Inc.

2026 East Cedar Street  
Tempe, Arizona 85281

480-967-8702

800-289-5386

Fax: 480-967-1907

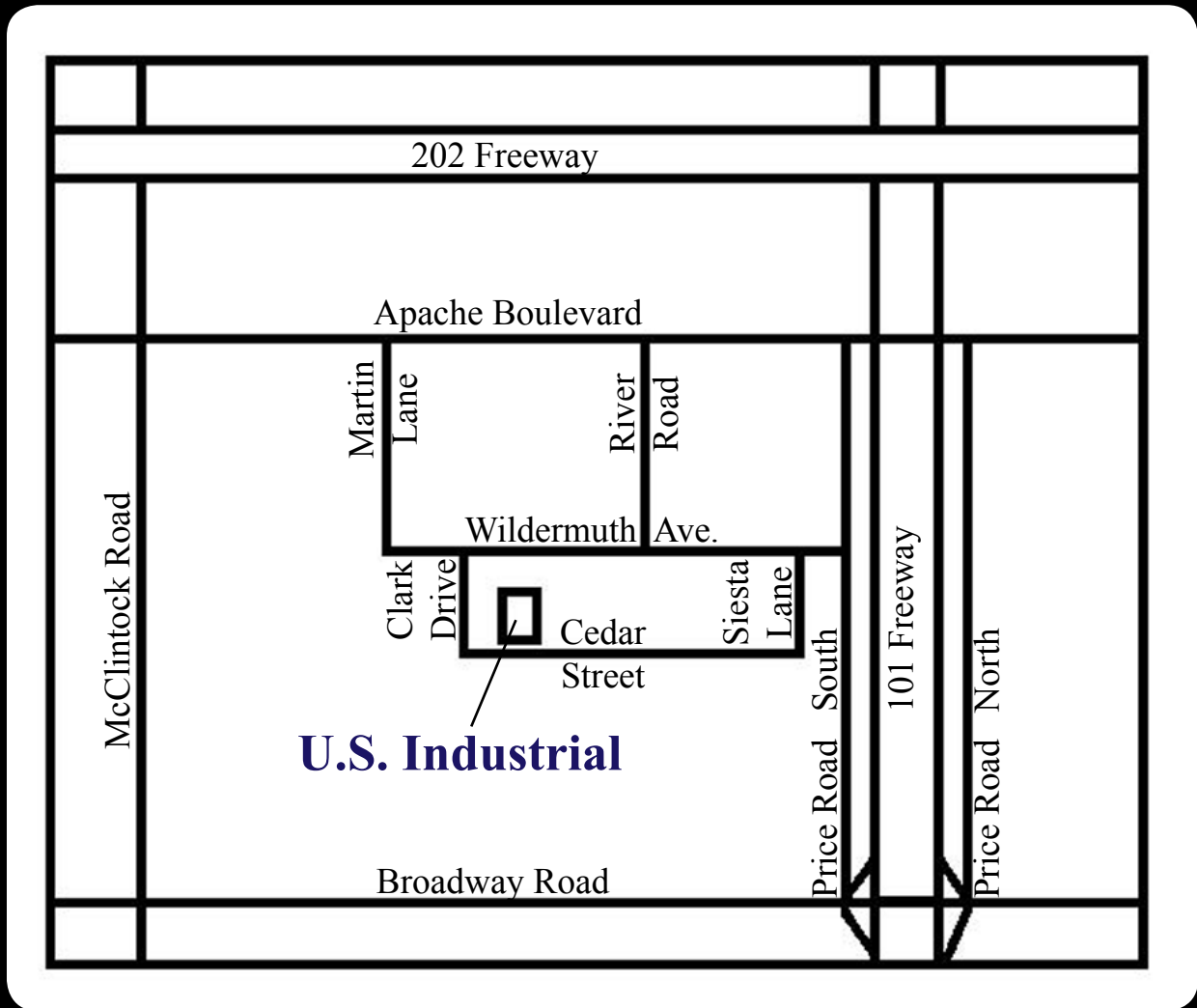

2026 East Cedar Street  
Tempe, Arizona 85281

[www.usifaz.com](http://www.usifaz.com)

Email: [sales@usifaz.com](mailto:sales@usifaz.com)